

# Outline of a New Approach to the Analysis of Complex Systems and Decision Processes

LOTFI A. ZADEH

**Abstract**—The approach described in this paper represents a substantive departure from the conventional quantitative techniques of system analysis. It has three main distinguishing features: 1) use of so-called "linguistic" variables in place of or in addition to numerical variables; 2) characterization of simple relations between variables by fuzzy conditional statements; and 3) characterization of complex relations by fuzzy algorithms.

A *linguistic variable* is defined as a variable whose values are sentences in a natural or artificial language. Thus, if *tall*, *not tall*, *very tall*, *very very tall*, etc. are values of *height*, then *height* is a linguistic variable. *Fuzzy conditional statements* are expressions of the form IF *A* THEN *B*, where *A* and *B* have fuzzy meaning, e.g., IF *x* is *small* THEN *y* is *large*, where *small* and *large* are viewed as labels of fuzzy sets. A *fuzzy algorithm* is an ordered sequence of instructions which may contain fuzzy assignment and conditional statements, e.g.,  $x = \text{very small}$ , IF *x* is *small* THEN *y* is *large*. The execution of such instructions is governed by the *compositional rule of inference* and the *rule of the preponderant alternative*.

By relying on the use of linguistic variables and fuzzy algorithms, the approach provides an approximate and yet effective means of describing the behavior of systems which are too complex or too ill-defined to admit of precise mathematical analysis. Its main applications lie in economics, management science, artificial intelligence, psychology, linguistics, information retrieval, medicine, biology, and other fields in which the dominant role is played by the animate rather than inanimate behavior of system constituents.

## I. INTRODUCTION

THE ADVENT of the computer age has stimulated a rapid expansion in the use of quantitative techniques for the analysis of economic, urban, social, biological, and other types of systems in which it is the animate rather than inanimate behavior of system constituents that plays a dominant role. At present, most of the techniques employed for the analysis of *humanistic*, i.e., human-centered, systems are adaptations of the methods that have been developed over a long period of time for dealing with *mechanistic* systems, i.e., physical systems governed in the main by the laws of mechanics, electromagnetism, and thermodynamics. The remarkable successes of these methods in unraveling the secrets of nature and enabling us to build better and better machines have inspired a widely held belief that the same or similar techniques can be applied with comparable effectiveness to the analysis of humanistic systems. As a case in point, the successes of modern control

theory in the design of highly accurate space navigation systems have stimulated its use in the theoretical analyses of economic and biological systems. Similarly, the effectiveness of computer simulation techniques in the macroscopic analyses of physical systems has brought into vogue the use of computer-based econometric models for purposes of forecasting, economic planning, and management.

Given the deeply entrenched tradition of scientific thinking which equates the understanding of a phenomenon with the ability to analyze it in quantitative terms, one is certain to strike a dissonant note by questioning the growing tendency to analyze the behavior of humanistic systems as if they were mechanistic systems governed by difference, differential, or integral equations. Such a note is struck in the present paper.

Essentially, our contention is that the conventional quantitative techniques of system analysis are intrinsically unsuited for dealing with humanistic systems or, for that matter, any system whose complexity is comparable to that of humanistic systems. The basis for this contention rests on what might be called the *principle of incompatibility*. Stated informally, the essence of this principle is that as the complexity of a system increases, our ability to make precise and yet significant statements about its behavior diminishes until a threshold is reached beyond which precision and significance (or relevance) become almost mutually exclusive characteristics.<sup>1</sup> It is in this sense that precise quantitative analyses of the behavior of humanistic systems are not likely to have much relevance to the real-world societal, political, economic, and other types of problems which involve humans either as individuals or in groups.

An alternative approach outlined in this paper is based on the premise that the key elements in human thinking are not numbers, but labels of fuzzy sets, that is, classes of objects in which the transition from membership to non-membership is gradual rather than abrupt. Indeed, the pervasiveness of fuzziness in human thought processes suggests that much of the logic behind human reasoning is not the traditional two-valued or even multivalued logic, but a logic with fuzzy truths, fuzzy connectives, and fuzzy rules of inference. In our view, it is this fuzzy, and as yet not well-understood, logic that plays a basic role in what may well be one of the most important facets of human thinking, namely, the ability to *summarize* information—to extract from the collections of masses of data impinging

Manuscript received August 1, 1972; revised August 13, 1972. This work was supported by the Navy Electronic Systems Command under Contract N00039-71-C-0255, the Army Research Office, Durham, N.C., under Grant DA-ARO-D-31-124-71-G174, and NASA under Grant NGL-05-003-016-VP3.

The author is with the Department of Electrical Engineering and Computer Sciences and Electronics Research Laboratory, University of California, Berkeley, Calif. 94720.

<sup>1</sup> A corollary principle may be stated succinctly as, "The closer one looks at a real-world problem, the fuzzier becomes its solution."

upon the human brain those and only those subcollections which are relevant to the performance of the task at hand.

By its nature, a summary is an approximation to what it summarizes. For many purposes, a very approximate characterization of a collection of data is sufficient because most of the basic tasks performed by humans do not require a high degree of precision in their execution. The human brain takes advantage of this tolerance for imprecision by encoding the "task-relevant" (or "decision-relevant") information into labels of fuzzy sets which bear an approximate relation to the primary data. In this way, the stream of information reaching the brain via the visual, auditory, tactile, and other senses is eventually reduced to the trickle that is needed to perform a specified task with a minimal degree of precision. Thus, the ability to manipulate fuzzy sets and the consequent summarizing capability constitute one of the most important assets of the human mind as well as a fundamental characteristic that distinguishes human intelligence from the type of machine intelligence that is embodied in present-day digital computers.

Viewed in this perspective, the traditional techniques of system analysis are not well suited for dealing with humanistic systems because they fail to come to grips with the reality of the fuzziness of human thinking and behavior. Thus, to deal with such systems realistically, we need approaches which do not make a fetish of precision, rigor, and mathematical formalism, and which employ instead a methodological framework which is tolerant of imprecision and partial truths. The approach described in the sequel is a step—but not necessarily a definitive step—in this direction.

The approach in question has three main distinguishing features: 1) use of so-called "linguistic" variables in place of or in addition to numerical variables; 2) characterization of simple relations between variables by conditional fuzzy statements; and 3) characterization of complex relations by fuzzy algorithms. Before proceeding to a detailed discussion of our approach, it will be helpful to sketch the principal ideas behind these features. We begin with a brief explanation of the notion of a linguistic variable.

1) *Linguistic and Fuzzy Variables*: As already pointed out, the ability to summarize information plays an essential role in the characterization of complex phenomena. In the case of humans, the ability to summarize information finds its most pronounced manifestation in the use of natural languages. Thus, each word  $x$  in a natural language  $L$  may be viewed as a summarized description of a fuzzy subset  $M(x)$  of a universe of discourse  $U$ , with  $M(x)$  representing the meaning of  $x$ . In this sense, the language as a whole may be regarded as a system for assigning atomic and composite labels (i.e., words, phrases, and sentences) to the fuzzy subsets of  $U$ . (This point of view is discussed in greater detail in [4] and [5].) For example, if the meaning of the noun *flower* is a fuzzy subset  $M(\text{flower})$ , and the meaning of the adjective *red* is a fuzzy subset  $M(\text{red})$ , then the meaning of the noun phrase *red flower* is given by the intersection of  $M(\text{red})$  and  $M(\text{flower})$ .

If we regard the color of an object as a variable, then its values, *red, blue, yellow, green, etc.*, may be interpreted as labels of fuzzy subsets of a universe of objects. In this sense, the attribute *color* is a *fuzzy variable*, that is, a variable whose values are labels of fuzzy sets. It is important to note that the characterization of a value of the variable *color* by a natural label such as *red* is much less precise than the numerical value of the wavelength of a particular color.

In the preceding example, the values of the variable *color* are atomic terms like *red, blue, yellow, etc.* More generally, the values may be sentences in a specified language, in which case we say that the variable is *linguistic*. To illustrate, the values of the fuzzy variable *height* might be expressible as *tall, not tall, somewhat tall, very tall, not very tall, very very tall, tall but not very tall, quite tall, more or less tall*. Thus, the values in question are sentences formed from the label *tall*, the negation *not*, the connectives *and* and *but*, and the hedges *very, somewhat, quite, and more or less*. In this sense, the variable *height* as defined above is a linguistic variable.

As will be seen in Section III, the main function of linguistic variables is to provide a systematic means for an approximate characterization of complex or ill-defined phenomena. In essence, by moving away from the use of quantified variables and toward the use of the type of linguistic descriptions employed by humans, we acquire a capability to deal with systems which are much too complex to be susceptible to analysis in conventional mathematical terms.

2) *Characterization of Simple Relations Between Fuzzy Variables by Conditional Statements*: In quantitative approaches to system analysis, a dependence between two numerically valued variables  $x$  and  $y$  is usually characterized by a table which, in words, may be expressed as a set of conditional statements, e.g., IF  $x$  is 5 THEN  $y$  is 10, IF  $x$  is 6 THEN  $y$  is 14, etc.

The same technique is employed in our approach, except that  $x$  and  $y$  are allowed to be fuzzy variables. In particular, if  $x$  and  $y$  are linguistic variables, the conditional statements describing the dependence of  $y$  on  $x$  might read (the following italicized words represent the values of fuzzy variables):

IF  $x$  is *small* THEN  $y$  is *very large*  
 IF  $x$  is *not very small* THEN  $y$  is *very very large*  
 IF  $x$  is *not small and not large* THEN  $y$  is *not very large*

and so forth.

Fuzzy conditional statements of the form IF  $A$  THEN  $B$ , where  $A$  and  $B$  are terms with a fuzzy meaning, e.g., "IF John is *nice* to you THEN you should be *kind* to him," are used routinely in everyday discourse. However, the meaning of such statements when used in communication between humans is poorly defined. As will be shown in Section V, the conditional statement IF  $A$  THEN  $B$  can be given a precise meaning even when  $A$  and  $B$  are fuzzy rather than nonfuzzy sets, provided the meanings of  $A$  and  $B$  are defined precisely as specified subsets of the universe of discourse.

In the preceding example, the relation between two fuzzy variables  $x$  and  $y$  is *simple* in the sense that it can be characterized as a set of conditional statements of the form IF  $A$  THEN  $B$ , where  $A$  and  $B$  are labels of fuzzy sets representing the values of  $x$  and  $y$ , respectively. In the case of more complex relations, the characterization of the dependence of  $y$  on  $x$  may require the use of a fuzzy algorithm. As indicated below, and discussed in greater detail in Section VI, the notion of a fuzzy algorithm plays a basic role in providing a means of approximate characterization of fuzzy concepts and their interrelations.

3) *Fuzzy-Algorithmic Characterization of Functions and Relations*: The definition of a fuzzy function through the use of fuzzy conditional statements is analogous to the definition of a nonfuzzy function  $f$  by a table of pairs  $(x, f(x))$ , in which  $x$  is a generic value of the argument of  $f$  and  $f(x)$  is the value of the function. Just as a nonfuzzy function can be defined algorithmically (e.g., by a program) rather than by a table, so a fuzzy function can be defined by a fuzzy algorithm rather than as a collection of fuzzy conditional statements. The same applies to the definition of sets, relations, and other constructs which are fuzzy in nature.

Essentially, a fuzzy algorithm [6] is an ordered sequence of instructions (like a computer program) in which some of the instructions may contain labels of fuzzy sets, e.g.:

Reduce  $x$  *slightly* if  $y$  is *large*

Increase  $x$  *very slightly* if  $y$  is *not very large and not very small*

If  $x$  is *small* then stop; otherwise increase  $x$  by 2.

By allowing an algorithm to contain instructions of this type, it becomes possible to give an approximate fuzzy-algorithmic characterization of a wide variety of complex phenomena. The important feature of such characterizations is that, though imprecise in nature, they may be perfectly adequate for the purposes of a specified task. In this way, fuzzy algorithms can provide an effective means of approximate description of objective functions, constraints, system performance, strategies, etc.

In what follows, we shall elaborate on some of the basic aspects of linguistic variables, fuzzy conditional statements, and fuzzy algorithms. However, we shall not attempt to present a definitive exposition of our approach and its applications. Thus, the present paper should be viewed primarily as an introductory outline of a method which departs from the tradition of precision and rigor in scientific analysis—a method whose approximate nature mirrors the fuzziness of human behavior and thereby offers a promise of providing a more realistic basis for the analysis of humanistic systems.

As will be seen in the following sections, the theoretical foundation of our approach is actually quite precise and rather mathematical in spirit. Thus, the source of imprecision in the approach is not the underlying theory, but the manner in which linguistic variables and fuzzy algorithms are applied to the formulation and solution of real-world problems. In effect, the level of precision in a particular

application can be adjusted to fit the needs of the task and the accuracy of the available data. This flexibility constitutes one of the important features of the method that will be described.

## II. FUZZY SETS: A SUMMARY OF RELEVANT PROPERTIES

In order to make our exposition self-contained, we shall summarize in this section those properties of fuzzy sets which will be needed in later sections. (More detailed discussions of topics in the theory of fuzzy sets which are relevant to the subject of the present paper may be found in [1]–[17].)

### Notation and Terminology

A fuzzy subset  $A$  of a universe of discourse  $U$  is characterized by a membership function  $\mu_A: U \rightarrow [0,1]$  which associates with each element  $y$  of  $U$  a number  $\mu_A(y)$  in the interval  $[0,1]$  which represents the grade of membership of  $y$  in  $A$ . The *support* of  $A$  is the set of points in  $U$  at which  $\mu_A(y)$  is positive. A *crossover point* in  $A$  is an element of  $U$  whose grade of membership in  $A$  is 0.5. A *fuzzy singleton* is a fuzzy set whose support is a single point in  $U$ . If  $A$  is a fuzzy singleton whose support is the point  $y$ , we write

$$A = \mu/y \quad (2.1)$$

where  $\mu$  is the grade of membership of  $y$  in  $A$ . To be consistent with this notation, a nonfuzzy singleton will be denoted by  $1/y$ .

A fuzzy set  $A$  may be viewed as the union (see (2.27)) of its constituent singletons. On this basis,  $A$  may be represented in the form

$$A = \int_U \mu_A(y)/y \quad (2.2)$$

where the integral sign stands for the union of the fuzzy singletons  $\mu_A(y)/y$ . If  $A$  has a finite support  $\{y_1, y_2, \dots, y_n\}$ , then (2.2) may be replaced by the summation

$$A = \mu_1/y_1 + \dots + \mu_n/y_n \quad (2.3)$$

or

$$A = \sum_{i=1}^n \mu_i/y_i \quad (2.4)$$

in which  $\mu_i$ ,  $i = 1, \dots, n$ , is the grade of membership of  $y_i$  in  $A$ . It should be noted that the  $+$  sign in (2.3) denotes the union (see (2.27)) rather than the arithmetic sum. In this sense of  $+$ , a finite universe of discourse  $U = \{y_1, y_2, \dots, y_n\}$  may be represented simply by the summation

$$U = y_1 + y_2 + \dots + y_n \quad (2.5)$$

or

$$U = \sum_{i=1}^n y_i \quad (2.6)$$

although, strictly, we should write (2.5) and (2.6) as

$$U = 1/y_1 + 1/y_2 + \dots + 1/y_n \quad (2.7)$$

and

$$U = \sum_{i=1}^n 1/y_i \quad (2.8)$$

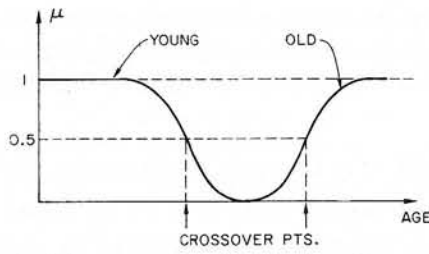

Fig. 1. Diagrammatic representation of *young* and *old*.

As an illustration, suppose that

$$U = 1 + 2 + \dots + 10. \quad (2.9)$$

Then a fuzzy subset<sup>2</sup> of  $U$  labeled *several* may be expressed as (the symbol  $\triangleq$  stands for "equal by definition," or "is defined to be," or "denotes")

$$several \triangleq 0.5/3 + 0.8/4 + 1/5 + 1/6 + 0.8/7 + 0.5/8. \quad (2.10)$$

Similarly, if  $U$  is the interval  $[0,100]$ , with  $y \triangleq$  age, then the fuzzy subsets of  $U$  labeled *young* and *old* may be represented as (here and elsewhere in this paper we do not differentiate between a fuzzy set and its label)

$$young = \int_0^{25} 1/y + \int_{25}^{100} \left(1 + \left(\frac{y-25}{5}\right)^2\right)^{-1} /y \quad (2.11)$$

$$old = \int_{50}^{100} \left(1 + \left(\frac{y-50}{5}\right)^2\right)^{-1} /y. \quad (2.12)$$

(see Fig. 1).

The grade of membership in a fuzzy set may itself be a fuzzy set. For example, if

$$U = TOM + JIM + DICK + BOB \quad (2.13)$$

and  $A$  is the fuzzy subset labeled *agile*, then we may have

$$agile = medium/TOM + low/JIM + low/DICK + high/BOB. \quad (2.14)$$

In this representation, the fuzzy grades of membership *low*, *medium*, and *high* are fuzzy subsets of the universe  $V$

$$V = 0 + 0.1 + 0.2 + \dots + 0.9 + 1 \quad (2.15)$$

which are defined by

$$low = 0.5/0.2 + 0.7/0.3 + 1/0.4 + 0.7/0.5 + 0.5/0.6 \quad (2.16)$$

$$medium = 0.5/0.4 + 0.7/0.5 + 1/0.6 + 0.7/0.7 + 0.5/0.8 \quad (2.17)$$

$$high = 0.5/0.7 + 0.7/0.8 + 0.9/0.9 + 1/1. \quad (2.18)$$

<sup>2</sup>  $A$  is a subset of  $B$ , written  $A \subset B$ , if and only if  $\mu_A(y) \leq \mu_B(y)$ , for all  $y$  in  $U$ . For example, the fuzzy set  $A = 0.6/1 + 0.3/2$  is a subset of  $B = 0.8/1 + 0.5/2 + 0.6/3$ .

### Fuzzy Relations

A *fuzzy relation*  $R$  from a set  $X$  to a set  $Y$  is a fuzzy subset of the Cartesian product  $X \times Y$ . ( $X \times Y$  is the collection of ordered pairs  $(x, y)$ ,  $x \in X, y \in Y$ ).  $R$  is characterized by a bivariate membership function  $\mu_R(x, y)$  and is expressed

$$R \triangleq \int_{X \times Y} \mu_R(x, y)/(x, y). \quad (2.19)$$

More generally, for an  $n$ -ary fuzzy relation  $R$  which is a fuzzy subset of  $X_1 \times X_2 \times \dots \times X_n$ , we have

$$R \triangleq \int_{X_1 \times \dots \times X_n} \mu_R(x_1, \dots, x_n)/(x_1, \dots, x_n), \quad x_i \in X_i, \quad i = 1, \dots, n. \quad (2.20)$$

As an illustration, if

$$X = \{TOM, DICK\} \quad \text{and} \quad Y = \{JOHN, JIM\}$$

then a binary fuzzy relation of *resemblance* between members of  $X$  and  $Y$  might be expressed as

$$resemblance = 0.8/(TOM, JOHN) + 0.6/(TOM, JIM) + 0.2/(DICK, JOHN) + 0.9/(DICK, JIM).$$

Alternatively, this relation may be represented as a *relation matrix*

$$\begin{matrix} & \begin{matrix} JOHN & JIM \end{matrix} \\ \begin{matrix} TOM \\ DICK \end{matrix} & \begin{bmatrix} 0.8 & 0.6 \\ 0.2 & 0.9 \end{bmatrix} \end{matrix} \quad (2.21)$$

in which the  $(i, j)$ th element is the value of  $\mu_R(x, y)$  for the  $i$ th value of  $x$  and the  $j$ th value of  $y$ .

If  $R$  is a relation from  $X$  to  $Y$  and  $S$  is a relation from  $Y$  to  $Z$ , then the *composition* of  $R$  and  $S$  is a fuzzy relation denoted by  $R \circ S$  and defined by

$$R \circ S \triangleq \int_{X \times Z} \vee_y (\mu_R(x, y) \wedge \mu_S(y, z))/(x, z) \quad (2.22)$$

where  $\vee$  and  $\wedge$  denote, respectively, max and min.<sup>3</sup> Thus, for real  $a, b$ ,

$$a \vee b = \max(a, b) \triangleq \begin{cases} a, & \text{if } a \geq b \\ b, & \text{if } a < b \end{cases} \quad (2.23)$$

$$a \wedge b = \min(a, b) \triangleq \begin{cases} a, & \text{if } a \leq b \\ b, & \text{if } a > b \end{cases} \quad (2.24)$$

and  $\vee_y$  is the supremum over the domain of  $y$ .

If the domains of the variables  $x, y$ , and  $z$  are finite sets, then the relation matrix for  $R \circ S$  is the max-min product<sup>4</sup> of the relation matrices for  $R$  and  $S$ . For example, the max-min product of the relation matrices on the left-hand side of (2.25) results in the relation matrix  $R \circ S$  shown on the

<sup>3</sup> Equation (2.22) defines the max-min composition of  $R$  and  $S$ . Max-product composition is defined similarly, except that  $\wedge$  is replaced by the arithmetic product. A more detailed discussion of these compositions may be found in [2].

<sup>4</sup> In the max-min matrix product, the operations of addition and multiplication are replaced by  $\vee$  and  $\wedge$ , respectively.

right-hand side of

$$\begin{array}{ccc} R & S & R \circ S \\ \begin{bmatrix} 0.3 & 0.8 \\ 0.6 & 0.9 \end{bmatrix} \circ \begin{bmatrix} 0.5 & 0.9 \\ 0.4 & 1 \end{bmatrix} & = & \begin{bmatrix} 0.4 & 0.8 \\ 0.5 & 0.9 \end{bmatrix} \end{array} \quad (2.25)$$

### Operations on Fuzzy Sets

The negation *not*, the connectives *and* and *or*, the hedges *very*, *highly*, *more or less*, and other terms which enter in the representation of values of linguistic variables may be viewed as labels of various operations defined on the fuzzy subsets of  $U$ . The more basic of these operations will be summarized.

The *complement* of  $A$  is denoted  $\neg A$  and is defined by

$$\neg A \triangleq \int_U (1 - \mu_A(y))/y. \quad (2.26)$$

The operation of complementation corresponds to negation. Thus, if  $x$  is a label for a fuzzy set, then *not*  $x$  should be interpreted as  $\neg x$ . (Strictly speaking,  $\neg$  operates on fuzzy sets, whereas *not* operates on their labels. With this understanding, we shall use  $\neg$  and *not* interchangeably.)

The *union* of fuzzy sets  $A$  and  $B$  is denoted  $A + B$  and is defined by

$$A + B \triangleq \int_U (\mu_A(y) \vee \mu_B(y))/y. \quad (2.27)$$

The union corresponds to the connective *or*. Thus, if  $u$  and  $v$  are labels of fuzzy sets, then

$$u \text{ or } v \triangleq u + v \quad (2.28)$$

The *intersection* of  $A$  and  $B$  is denoted  $A \cap B$  and is defined by

$$A \cap B \triangleq \int_U (\mu_A(y) \wedge \mu_B(y))/y. \quad (2.29)$$

The intersection corresponds to the connective *and*; thus

$$u \text{ and } v \triangleq u \cap v. \quad (2.30)$$

As an illustration, if

$$U = 1 + 2 + \cdots + 10 \quad (2.31)$$

$$u = 0.8/3 + 1/5 + 0.6/6 \quad (2.32)$$

$$v = 0.7/3 + 1/4 + 0.5/6 \quad (2.33)$$

then

$$u \text{ or } v = 0.8/3 + 1/4 + 1/5 + 0.6/6 \quad (2.34)$$

$$u \text{ and } v = 0.7/3 + 0.5/6. \quad (2.35)$$

The *product* of  $A$  and  $B$  is denoted  $AB$  and is defined by

$$AB \triangleq \int_U \mu_A(y)\mu_B(y)/y. \quad (2.36)$$

Thus, if

$$A = 0.8/2 + 0.9/5 \quad (2.37)$$

$$B = 0.6/2 + 0.8/3 + 0.6/5 \quad (2.38)$$

then

$$AB = 0.48/2 + 0.54/5. \quad (2.39)$$

Based on (2.36),  $A^\alpha$ , where  $\alpha$  is any positive number, is defined by

$$A^\alpha \triangleq \int_U (\mu_A(y))^\alpha/y. \quad (2.40)$$

Similarly, if  $\alpha$  is a nonnegative real number, then

$$\alpha A \triangleq \int_U \alpha \mu_A(y)/y. \quad (2.41)$$

As an illustration, if  $A$  is expressed by (2.37), then

$$A^2 = 0.64/2 + 0.81/5 \quad (2.42)$$

$$0.5A = 0.4/2 + 0.45/5. \quad (2.43)$$

In addition to the basic operations just defined, there are other operations that are of use in the representation of linguistic hedges. Some of these will be briefly defined. (A more detailed discussion of these operations may be found in [15].)

The operation of *concentration* is defined by

$$\text{CON}(A) \triangleq A^2. \quad (2.44)$$

Applying this operation to  $A$  results in a fuzzy subset of  $A$  such that the reduction in the magnitude of the grade of membership of  $y$  in  $A$  is relatively small for those  $y$  which have a high grade of membership in  $A$  and relatively large for the  $y$  with low membership.

The operation of *dilation* is defined by

$$\text{DIL}(A) \triangleq A^{0.5}. \quad (2.45)$$

The effect of this operation is the opposite of that of concentration.

The operation of *contrast intensification* is defined by

$$\text{INT}(A) \triangleq \begin{cases} 2A^2, & \text{for } 0 \leq \mu_A(y) \leq 0.5 \\ -2(\neg A)^2, & \text{for } 0.5 \leq \mu_A(y) \leq 1. \end{cases} \quad (2.46)$$

This operation differs from concentration in that it increases the values of  $\mu_A(y)$  which are above 0.5 and diminishes those which are below this point. Thus, contrast intensification has the effect of reducing the fuzziness of  $A$ . (An entropy-like measure of fuzziness of a fuzzy set is defined in [16].)

As its name implies, the operation of *fuzzification* (or, more specifically, *support fuzzification*) has the effect of transforming a nonfuzzy set into a fuzzy set or increasing the fuzziness of a fuzzy set. The result of application of a fuzzification to  $A$  will be denoted by  $F(A)$  or  $\tilde{A}$ , with the wavy overbar referred to as a *fuzzifier*. Thus  $x \approx 3$  means "x is approximately equal to 3," while  $x = \tilde{3}$  means "x is a fuzzy set which approximates to 3." A fuzzifier  $F$  is characterized by its *kernel*  $K(y)$ , which is the fuzzy set resulting from the application of  $F$  to a singleton  $1/y$ . Thus

$$K(y) \triangleq \tilde{1}/y. \quad (2.47)$$

In terms of  $K$ , the result of applying  $F$  to a fuzzy set  $A$  is given by

$$F(A; K) \triangleq \int_U \mu_A(y)K(y) \quad (2.48)$$

where  $\mu_A(y)K(y)$  represents the product (in the sense of (2.41)) of the scalar  $\mu_A(y)$  and the fuzzy set  $K(y)$ , and  $\int_U$  should be interpreted as the union of the family of fuzzy sets  $\mu_A(y)K(y)$ ,  $y \in U$ . Thus (2.48) is analogous to the integral representation of a linear operator, with  $K(y)$  playing the role of impulse response.

As an illustration of (2.48), assume that  $U$ ,  $A$ , and  $K(y)$  are defined by

$$U = 1 + 2 + 3 + 4 \tag{2.49}$$

$$A = 0.8/1 + 0.6/2 \tag{2.50}$$

$$K(1) = 1/1 + 0.4/2 \tag{2.51}$$

$$K(2) = 1/2 + 0.4/1 + 0.4/3.$$

Then, the result of applying  $F$  to  $A$  is given by

$$\begin{aligned} F(A; K) &= 0.8(1/1 + 0.4/2) + 0.6(1/2 + 0.4/1 + 0.4/3) \\ &= 0.8/1 + 0.32/2 + 0.6/2 + 0.24/1 + 0.24/3 \\ &= 0.8/1 + 0.6/2 + 0.24/3. \end{aligned} \tag{2.52}$$

The operation of fuzzification plays an important role in the definition of linguistic hedges such as *more or less*, *slightly*, *much*, etc. Examples of its uses are given in [15].

#### Language and Meaning

As was indicated in Section I, the values of a linguistic variable are fuzzy sets whose labels are sentences in a natural or artificial language. For our purposes, a language  $L$  may be viewed as a correspondence between a set of terms  $T$  and a universe of discourse  $U$ . (This point of view is described in greater detail in [4] and [5]. For simplicity, we assume that  $T$  is a nonfuzzy set.) This correspondence may be assumed to be characterized by a fuzzy naming relation  $N$  from  $T$  to  $U$ , which associates with each term  $x$  in  $T$  and each object  $y$  in  $U$  the degree  $\mu_N(x,y)$  to which  $x$  applies to  $y$ . For example, if  $x = \textit{young}$  and  $y = 23$  years, then  $\mu_N(\textit{young}, 23)$  might be 0.9. A term may be atomic, e.g.,  $x = \textit{tall}$ , or composite, in which case it is a concatenation of atomic terms, e.g.,  $x = \textit{very tall man}$ .

For a fixed  $x$ , the membership function  $\mu_N(x,y)$  defines a fuzzy subset  $M(x)$  of  $U$  whose membership function is given by

$$\mu_{M(x)}(y) \triangleq \mu_N(x,y), \quad x \in T, \quad y \in U. \tag{2.53}$$

This fuzzy subset is defined to be the *meaning* of  $x$ . Thus, the meaning of a term  $x$  is the fuzzy subset  $M(x)$  of  $U$  for which  $x$  serves as a label. Although  $x$  and  $M(x)$  are different entities ( $x$  is an element of  $T$ , whereas  $M(x)$  is a fuzzy subset of  $U$ ), we shall write  $x$  for  $M(x)$ , except where there is a need for differentiation between them. To illustrate, suppose that the meaning of the term *young* is defined by

$$\mu_N(\textit{young}, y) = \begin{cases} 1, & \text{for } y \leq 25 \\ \left(1 + \left(\frac{y - 25}{5}\right)^2\right)^{-1}, & \text{for } y > 25. \end{cases} \tag{2.54}$$

Then we can represent the fuzzy subset of  $U$  labeled *young* as (see (2.11))

$$\textit{young} = \int_0^{25} 1/y + \int_{25}^{100} \left(1 + \left(\frac{y - 25}{5}\right)^2\right)^{-1} /y \tag{2.55}$$

with the right-hand member of (2.55) representing the meaning of *young*.

Linguistic hedges such as *very*, *much*, *more or less*, etc., make it possible to modify the meaning of atomic as well as composite terms and thus serve to increase the range of values of a linguistic variable. The use of linguistic hedges for this purpose is discussed in the following section.

### III. LINGUISTIC HEDGES

As stated in Section II, the values of a linguistic variable are labels of fuzzy subsets of  $U$  which have the form of phrases or sentences in a natural or artificial language. For example, if  $U$  is the collection of integers

$$U = 0 + 1 + 2 + \dots + 100 \tag{3.1}$$

and *age* is a linguistic variable labeled  $x$ , then the values of  $x$  might be *young*, *not young*, *very young*, *not very young*, *old and not old*, *not very old*, *not young and not old*, etc.

In general, a value of a linguistic variable is a composite term  $x = x_1x_2 \dots x_n$ , which is a concatenation of atomic terms  $x_1, \dots, x_n$ . These atomic terms may be divided into four categories:

- 1) *primary terms*, which are labels of specified fuzzy subsets of the universe of discourse (e.g., *young* and *old* in the preceding example);
- 2) the negation *not* and the connectives *and* and *or*;
- 3) *hedges*, such as *very*, *much*, *slightly*, *more or less* (although *more or less* is comprised of three words, it is regarded as an atomic term), etc.;
- 4) *markers*, such as parentheses.

A basic problem  $P_1$  which arises in connection with the use of linguistic variables is the following: Given the meaning of each atomic term  $x_i$ ,  $i = 1, \dots, n$ , in a composite term  $x = x_1 \dots x_n$  which represents a value of a linguistic variable, compute the meaning of  $x$  in the sense of (2.53). This problem is an instance of a central problem in quantitative fuzzy semantics [4], namely, the computation of the meaning of a composite term.  $P_1$  is a special case of the latter problem because the composite terms representing the values of a linguistic variable have a relatively simple grammatical structure which is restricted to the four categories of atomic terms 1)–4).

As a preliminary to describing a general approach to the solution of  $P_1$ , it will be helpful to consider a subproblem of  $P_1$  which involves the computation of the meaning of a composite term of the form  $x = hu$ , where  $h$  is a hedge and  $u$  is a term with a specified meaning; e.g.,  $x = \textit{very tall man}$ , where  $h = \textit{very}$  and  $u = \textit{tall man}$ .

Taking the point of view described in [15], a hedge  $h$  may be regarded as an operator which transforms the fuzzy set  $M(u)$ , representing the meaning of  $u$ , into the fuzzy set  $M(hu)$ . As stated already, the hedges serve the function of

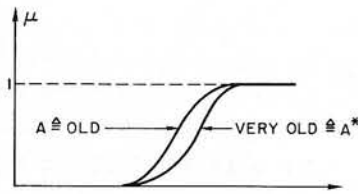
Fig. 2. Effect of hedge *very*.

generating a larger set of values for a linguistic variable from a small collection of primary terms. For example, by using the hedge *very* in conjunction with *not*, *and*, and the primary term *tall*, we can generate the fuzzy sets *very tall*, *very very tall*, *not very tall*, *tall and not very tall*, etc. To define a hedge *h* as an operator, it is convenient to employ some of the basic operations defined in Section II, especially concentration, dilation, and fuzzification. In what follows, we shall indicate the manner in which this can be done for the natural hedge *very* and the artificial hedges *plus* and *minus*. Characterizations of such hedges as *more or less*, *much*, *slightly*, *sort of*, and *essentially* may be found in [15].

Although in its everyday use the hedge *very* does not have a well-defined meaning, in essence it acts as an intensifier, generating a subset of the set on which it operates. A simple operation which has this property is that of concentration (see (2.44)). This suggests that *very x*, where *x* is a term, be defined as the square of *x*, that is

$$\text{very } x \triangleq x^2 \quad (3.2)$$

or, more explicitly

$$\text{very } x \triangleq \int_U \mu_x^2(y)/y. \quad (3.3)$$

For example, if (see Fig. 2)

$$x = \text{old men} \triangleq \int_{50}^{100} \left(1 + \left(\frac{y-50}{5}\right)^{-2}\right)^{-1} / y \quad (3.4)$$

then

$$x^2 = \text{very old men} = \int_{50}^{100} \left(1 + \left(\frac{y-50}{5}\right)^{-2}\right)^{-2} / y. \quad (3.5)$$

Thus, if the grade of membership of JOHN in the class of *old men* is 0.8, then his grade of membership in the class of *very old men* is 0.64. As another simple example, if

$$U = 1 + 2 + 3 + 4 + 5 \quad (3.6)$$

and

$$\text{small} = 1/1 + 0.8/2 + 0.6/3 + 0.4/4 + 0.2/5 \quad (3.7)$$

then

$$\text{very small} = 1/1 + 0.64/2 + 0.36/3 + 0.16/4 + 0.04/5. \quad (3.8)$$

Viewed as an operator, *very* can be composed with itself. Thus

$$\text{very very } x = (\text{very } x)^2 = x^4. \quad (3.9)$$

For example, applying (3.9) to (3.7), we obtain (neglecting small terms)

$$\text{very very small} = 1/1 + 0.4/2 + 0.1/3. \quad (3.10)$$

In some instances, to identify the operand of *very* we have to use parentheses or replace a composite term by an atomic one. For example, it is not grammatical to write

$$x = \text{very not exact} \quad (3.11)$$

but if *not exact* is replaced by the atomic term *inexact*, then

$$x = \text{very inexact} \quad (3.12)$$

is grammatically correct and we can write

$$x = (\neg \text{exact})^2. \quad (3.13)$$

Note that

$$\text{not very exact} = \neg(\text{very exact}) = \neg(\text{exact}^2) \quad (3.14)$$

is not the same as (3.13).

The artificial hedges *plus* and *minus* serve the purpose of providing milder degrees of concentration and dilation than those associated with the operations CON and DIL (see (2.44), (2.45)). Thus, as operators acting on a fuzzy set labeled *x*, *plus* and *minus* are defined by

$$\text{plus } x \triangleq x^{1.25} \quad (3.15)$$

$$\text{minus } x \triangleq x^{0.75}. \quad (3.16)$$

In consequence of (3.15) and (3.16), we have the approximate identity

$$\text{plus plus } x = \text{minus very } x. \quad (3.17)$$

As an illustration, if the hedge *highly* is defined as

$$\text{highly} = \text{minus very very} \quad (3.18)$$

then, equivalently,

$$\text{highly} = \text{plus plus very}. \quad (3.19)$$

As was stated earlier, the computation of the meaning of composite terms of the form *hu* is a preliminary to the problem of computing the meaning of values of a linguistic variable. We are now in a position to turn our attention to this problem.

#### IV. COMPUTATION OF THE MEANING OF VALUES OF A LINGUISTIC VARIABLE

Once we know how to compute the meaning of a composite term of the form *hu*, the computation of the meaning of a more complex composite term, which may involve the terms *not*, *or*, and *and* in addition to terms of the form *hu*, becomes a relatively simple problem which is quite similar to that of the computation of the value of a Boolean expression. As a simple illustration, consider the computation of the meaning of the composite term

$$x = \text{not very small} \quad (4.1)$$

where the primary term *small* is defined as

$$\text{small} = 1/1 + 0.8/2 + 0.6/3 + 0.4/4 + 0.2/5 \quad (4.2)$$

with the universe of discourse being

$$U = 1 + 2 + 3 + 4 + 5. \quad (4.3)$$

By (3.8), the operation of *very* on *small* yields

$$\text{very small} = 1/1 + 0.64/2 + 0.36/3 + 0.16/4 + 0.04/5 \quad (4.4)$$

and, by (2.26),

$$\begin{aligned} \text{not very small} &= \neg(\text{very small}) \\ &= 0.36/2 + 0.64/3 + 0.84/4 + 0.96/5 \\ &\approx 0.4/2 + 0.6/3 + 0.8/4 + 1/5. \end{aligned} \quad (4.5)$$

As a slightly more complicated example, consider the composite term

$$x = \text{not very small and not very very large} \quad (4.6)$$

where *large* is defined by

$$\text{large} = 0.2/1 + 0.4/2 + 0.6/3 + 0.8/4 + 1/5. \quad (4.7)$$

In this case,

$$\begin{aligned} \text{very large} &= \text{large}^2 \\ &= 0.04/1 + 0.16/2 + 0.36/3 + 0.64/4 \\ &\quad + 1/5 \end{aligned} \quad (4.8)$$

$$\begin{aligned} \text{very very large} &= (\text{large}^2)^2 \\ &\approx 0.1/3 + 0.4/4 + 1/5 \end{aligned} \quad (4.9)$$

$$\text{not very very large} \approx 1/1 + 1/2 + 0.9/3 + 0.6/4 \quad (4.10)$$

and hence

$$\begin{aligned} \text{not very small and not very very large} \\ &\approx (0.4/2 + 0.6/3 + 0.8/4 + 1/5) \\ &\quad \cap (1/1 + 1/2 + 0.9/3 + 0.6/4) \\ &\approx 0.4/2 + 0.6/3 + 0.6/4. \end{aligned} \quad (4.11)$$

An example of a different nature is provided by the values of a linguistic variable labeled *likelihood*. In this case, we assume that the universe of discourse is given by

$$\begin{aligned} U &= 0 + 0.1 + 0.2 + 0.3 + 0.4 + 0.5 \\ &\quad + 0.6 + 0.7 + 0.8 + 0.9 + 1 \end{aligned} \quad (4.12)$$

in which the elements of *U* represent probabilities. Suppose that we wish to compute the meaning of the value

$$x = \text{highly unlikely} \quad (4.13)$$

in which *highly* is defined as (see (3.18))

$$\text{highly} = \text{minus very very} \quad (4.14)$$

and

$$\text{unlikely} = \text{not likely} \quad (4.15)$$

with the meaning of the primary term *likely* given by

$$\begin{aligned} \text{likely} &= 1/1 + 1/0.9 + 1/0.8 + 0.8/0.7 \\ &\quad + 0.6/0.6 + 0.5/0.5 + 0.3/0.4 + 0.2/0.3. \end{aligned} \quad (4.16)$$

Using (4.15), we obtain

$$\begin{aligned} \text{unlikely} &= 1/0 + 1/0.1 + 1/0.2 + 0.8/0.3 + 0.7/0.4 \\ &\quad + 0.5/0.5 + 0.4/0.6 + 0.2/0.7 \end{aligned} \quad (4.17)$$

and hence

$$\begin{aligned} \text{very very unlikely} \\ &= (\text{unlikely})^4 \\ &\approx 1/0 + 1/0.1 + 1/0.2 + 0.4/0.3 + 0.2/0.4. \end{aligned} \quad (4.18)$$

Finally, by (4.14)

$$\begin{aligned} \text{highly unlikely} \\ &= \text{minus very very unlikely} \\ &\approx (1/0 + 1/0.1 + 1/0.2 + 0.4/0.3 + 0.2/0.4)^{0.75} \\ &\approx 1/0 + 1/0.1 + 1/0.2 + 0.5/0.3 + 0.3/0.4. \end{aligned} \quad (4.19)$$

It should be noted that in computing the meaning of composite terms in the preceding examples we have made implicit use of the usual precedence rules governing the evaluation of Boolean expressions. With the addition of hedges, these precedence rules may be expressed as follows.

Precedence	Operation
First	<i>h, not</i>
Second	<i>and</i>
Third	<i>or</i>

As usual, parentheses may be used to change the precedence order and ambiguities may be resolved by the use of association to the right. Thus *plus very minus very tall* should be interpreted as

$$\text{plus (very (minus (very (tall))))}.$$

The technique that was employed for the computation of the meaning of a composite term is a special case of a more general approach which is described in [4] and [5]. The approach in question can be applied to the computation of the meaning of values of a linguistic variable provided the composite terms representing these values can be generated by a context-free grammar. As an illustration, consider a linguistic variable *x* whose values are exemplified by *small, not small, large, not large, very small, not very small, small or not very very large, small and (large or not small), not very very small and not very very large*, etc.

The values in question can be generated by a context-free grammar  $G = (V_T, V_N, S, P)$  in which the set of terminals  $V_T$  comprises the atomic terms *small, large, not, and, or, very*, etc.; the nonterminals are denoted *S, A, B, C, D*, and *E*; and the production system is given by

$$\begin{aligned} S &\rightarrow A & C &\rightarrow D \\ S &\rightarrow S \text{ or } A & C &\rightarrow E \\ A &\rightarrow B & D &\rightarrow \text{very } D \\ A &\rightarrow A \text{ and } B & E &\rightarrow \text{very } E \\ B &\rightarrow C & D &\rightarrow \text{small} \\ B &\rightarrow \text{not } C & E &\rightarrow \text{large} \\ C &\rightarrow (S). \end{aligned} \quad (4.20)$$



Each production in (4.20) gives rise to a relation between the fuzzy sets labeled by the corresponding terminal and nonterminal symbols. In the case of (4.20), these relations are (we omit the productions which have no effect on the associated fuzzy sets)

$$\begin{aligned}
S &\rightarrow S \text{ or } A \Rightarrow S_L = S_R + A_R \\
A &\rightarrow A \text{ and } B \Rightarrow A_L = A_R \cap B_R \\
B &\rightarrow \text{not } C \Rightarrow B_L = \neg C_R \\
D &\rightarrow \text{very } D \Rightarrow D_L = D_R^2 \\
E &\rightarrow \text{very } E \Rightarrow E_L = E_R^2 \\
D &\rightarrow \text{small} \Rightarrow D_L = \text{small} \\
E &\rightarrow \text{large} \Rightarrow E_L = \text{large}
\end{aligned} \tag{4.21}$$

in which the subscripts  $L$  and  $R$  are used to differentiate between the symbols on the left- and right-hand sides of a production.

To compute the meaning of a composite term  $x$ , it is necessary to perform a syntactical analysis of  $x$  in terms of the specified grammar  $G$ . Then, knowing the syntax tree of  $x$ , one can employ the relations given in (4.21) to derive a set of equations (in triangular form) which upon solution yield the meaning of  $x$ . For example, in the case of the composite term

$$x = \text{not very small and not very very large}$$

the solution of these equations yields

$$x = (\neg \text{small}^2) \cap (\neg \text{large}^4) \tag{4.22}$$

which agrees with (4.11). Details of this solution may be found in [4] and [5].

The ability to compute the meaning of values of a linguistic variable is a prerequisite to the computation of the meaning of fuzzy conditional statements of the form IF  $A$  THEN  $B$ , e.g., IF  $x$  is *not very small* THEN  $y$  is *very very large*. This problem is considered in the following section.

#### V. FUZZY CONDITIONAL STATEMENTS AND COMPOSITIONAL RULE OF INFERENCE

In classical propositional calculus,<sup>5</sup> the expression IF  $A$  THEN  $B$ , where  $A$  and  $B$  are propositional variables, is written as  $A \Rightarrow B$ , with the implication  $\Rightarrow$  regarded as a connective which is defined by the truth table.

$A$	$B$	$A \Rightarrow B$
$T$	$T$	$T$
$T$	$F$	$F$
$F$	$T$	$T$
$F$	$F$	$T$

Thus,

$$A \Rightarrow B \equiv \neg A \vee B \tag{5.1}$$

<sup>5</sup> A detailed discussion of the significance of implication and its role in modal logic may be found in [18].

in the sense that the propositional expressions  $A \Rightarrow B$  ( $A$  implies  $B$ ) and  $\neg A \vee B$  (*not A or B*) have identical truth tables.

A more general concept, which plays an important role in our approach, is a *fuzzy conditional statement*: IF  $A$  THEN  $B$  or, for short,  $A \Rightarrow B$ , in which  $A$  (the antecedent) and  $B$  (the consequent) are fuzzy sets rather than propositional variables. The following are typical examples of such statements:

IF *large* THEN *small*  
IF *slippery* THEN *dangerous*

which are abbreviations of the statements

IF  $x$  is *large* THEN  $y$  is *small*  
IF the road is *slippery* THEN driving is *dangerous*.

In essence, statements of this form describe a relation between two fuzzy variables. This suggests that a fuzzy conditional statement be defined as a fuzzy relation in the sense of (2.19) rather than as a connective in the sense of (5.1).

To this end, it is expedient to define first the *Cartesian product* of two fuzzy sets. Specifically, let  $A$  be a fuzzy subset of a universe of discourse  $U$ , and let  $B$  be a fuzzy subset of a possibly different universe of discourse  $V$ . Then, the Cartesian product of  $A$  and  $B$  is denoted by  $A \times B$  and is defined by

$$A \times B \triangleq \int_{U \times V} \mu_A(u) \wedge \mu_B(v)/(u,v) \tag{5.2}$$

where  $U \times V$  denotes the Cartesian product of the non-fuzzy sets  $U$  and  $V$ ; that is,

$$U \times V \triangleq \{(u,v) \mid u \in U, v \in V\}.$$

Note that when  $A$  and  $B$  are nonfuzzy, (5.2) reduces to the conventional definition of the Cartesian product of non-fuzzy sets. In words, (5.2) means that  $A \times B$  is a fuzzy set of ordered pairs  $(u,v)$ ,  $u \in U$ ,  $v \in V$ , with the grade of membership of  $(u,v)$  in  $A \times B$  given by  $\mu_A(u) \wedge \mu_B(v)$ . In this sense,  $A \times B$  is a fuzzy relation from  $U$  to  $V$ .

As a very simple example, suppose that

$$U = 1 + 2 \tag{5.3}$$

$$V = 1 + 2 + 3 \tag{5.4}$$

$$A = 1/1 + 0.8/2 \tag{5.5}$$

$$B = 0.6/1 + 0.9/2 + 1/3. \tag{5.6}$$

Then

$$\begin{aligned}
A \times B &= 0.6/(1,1) + 0.9/(1,2) + 1/(1,3) \\
&\quad + 0.6/(2,1) + 0.8/(2,2) + 0.8/(2,3). \tag{5.7}
\end{aligned}$$

The relation defined by (5.7) may be conveniently represented by the relation matrix

$$\begin{matrix} & \begin{matrix} 1 & 2 & 3 \end{matrix} \\ \begin{matrix} 1 \\ 2 \end{matrix} & \begin{bmatrix} 0.6 & 0.9 & 1 \\ 0.6 & 0.8 & 0.8 \end{bmatrix} \end{matrix} \tag{5.8}$$

The significance of a fuzzy conditional statement of the form IF  $A$  THEN  $B$  is made clearer by regarding it as a special case of the conditional expression IF  $A$  THEN  $B$  ELSE  $C$ , where  $A$  and ( $B$  and  $C$ ) are fuzzy subsets of possibly different universes  $U$  and  $V$ , respectively. In terms of the Cartesian product, the latter statement is defined as follows:

$$\text{IF } A \text{ THEN } B \text{ ELSE } C \triangleq A \times B + (\neg A \times C) \quad (5.9)$$

in which  $+$  stands for the union of the fuzzy relations  $A \times B$  and  $(\neg A \times C)$ .

More generally, if  $A_1, \dots, A_n$  are fuzzy subsets of  $U$ , and  $B_1, \dots, B_n$  are fuzzy subsets of  $V$ , then<sup>6</sup>

$$\begin{aligned} &\text{IF } A_1 \text{ THEN } B_1 \text{ ELSE IF } A_2 \text{ THEN } B_2 \cdots \text{ ELSE IF } A_n \text{ THEN } B_n \\ &\triangleq A_1 \times B_1 + A_2 \times B_2 + \cdots + A_n \times B_n. \end{aligned} \quad (5.10)$$

Note that (5.10) reduces to (5.9) if IF  $A$  THEN  $B$  ELSE  $C$  is interpreted as IF  $A$  THEN  $B$  ELSE IF  $\neg A$  THEN  $C$ . It should also be noted that by repeated application of (5.9) we obtain

$$\begin{aligned} &\text{IF } A \text{ THEN (IF } B \text{ THEN } C \text{ ELSE } D) \text{ ELSE } E \\ &= A \times B \times C + A \times \neg B \times D + \neg A \times E. \end{aligned} \quad (5.11)$$

If we regard IF  $A$  THEN  $B$  as IF  $A$  THEN  $B$  ELSE  $C$  with unspecified  $C$ , then, depending on the assumption made about  $C$ , various interpretations of IF  $A$  THEN  $B$  will result. In particular, if we assume that  $C = V$ , then IF  $A$  THEN  $B$  (or  $A \Rightarrow B$ ) becomes<sup>7</sup>

$$A \Rightarrow B \triangleq \text{IF } A \text{ THEN } B \triangleq A \times B + (\neg A \times V). \quad (5.12)$$

If, in addition, we set  $A = U$  in (5.12), we obtain as an alternative definition

$$A \Rightarrow B \triangleq U \times B + (\neg A \times V). \quad (5.13)$$

In the sequel, we shall assume that  $C = V$ , and hence that  $A \Rightarrow B$  is defined by (5.12). In effect, the assumption that  $C = V$  implies that, in the absence of an indication to the contrary, the consequent of  $\neg A \Rightarrow C$  can be any fuzzy subset of the universe of discourse. As a very simple illustration of (5.12), suppose that  $A$  and  $B$  are defined by (5.5) and (5.6). Then, on substituting (5.8) in (5.12), the relation matrix for  $A \Rightarrow B$  is found to be

$$A \Rightarrow B = \begin{bmatrix} 0.6 & 0.9 & 1 \\ 0.6 & 0.8 & 0.8 \end{bmatrix}.$$

It should be observed that when  $A$ ,  $B$ , and  $C$  are non-fuzzy sets, we have the identity

$$\text{IF } A \text{ THEN } B \text{ ELSE } C = (\text{IF } A \text{ THEN } B) \cap (\text{IF } \neg A \text{ THEN } C) \quad (5.14)$$

<sup>6</sup> It should be noted that, in the sense used in ALGOL, the right-hand side of (5.10) would be expressed as  $A_1 \times B_1 + (\neg A_1 \cap A_2) \times B_2 + \cdots + (\neg A_1 \cap \cdots \cap \neg A_{n-1} \cap A_n) \times B_n$  when the  $A_i$  and  $B_i$ ,  $i = 1, \dots, n$ , are nonfuzzy sets.

<sup>7</sup> This definition should be viewed as tentative in nature.

which holds only approximately for fuzzy  $A$ ,  $B$ , and  $C$ . This indicates that, in relation to (5.15), the definitions of IF  $A$  THEN  $B$  ELSE  $C$  and IF  $A$  THEN  $B$ , as expressed by (5.9) and (5.12), are not exactly consistent for fuzzy  $A$ ,  $B$ , and  $C$ . It should also be noted that if 1)  $U = V$ , 2)  $x = y$ , and 3)  $A \Rightarrow B$  holds for all points in  $U$ , then, by (5.12),

$$A \Rightarrow B \text{ implies and is implied by } A \subset B \quad (5.15)$$

exactly if  $A$  and  $B$  are nonfuzzy and approximately otherwise.

As will be seen in Section VI, fuzzy conditional statements play a basic role in fuzzy algorithms. More specifically, a typical problem which is encountered in the course of execution of such algorithms is the following. We have a fuzzy relation, say,  $R$ , from  $U$  to  $V$  which is defined by a fuzzy conditional statement. Then, we are given a fuzzy subset of  $U$ , say,  $x$ , and have to determine the fuzzy subset of  $V$ , say,  $y$ , which is induced in  $V$  by  $x$ . For example, we may have the following two statements.

- 1)  $x$  is very small
- 2) IF  $x$  is small THEN  $y$  is large ELSE  $y$  is not very large

of which the second defines by (5.9) a fuzzy relation  $R$ . The question, then, is as follows: What will be the value of  $y$  if  $x$  is very small? The answer to this question is provided by the following rule of inference, which may be regarded as an extension of the familiar rule of *modus ponens*.

*Compositional Rule of Inference:* If  $R$  is a fuzzy relation from  $U$  to  $V$ , and  $x$  is a fuzzy subset of  $U$ , then the fuzzy subset  $y$  of  $V$  which is induced by  $x$  is given by the composition (see (2.22)) of  $R$  and  $x$ ; that is,

$$y = x \circ R \quad (5.16)$$

in which  $x$  plays the role of a unary relation.<sup>8</sup>

As a simple illustration of (5.16), suppose that  $R$  and  $x$  are defined by the relation matrices in (5.17). Then  $y$  is given by the max-min product of  $x$  and  $R$ :

$$x \quad R \quad y$$

$$[0.2 \quad 1 \quad 0.3] \circ \begin{bmatrix} 0.8 & 0.9 & 0.2 \\ 0.6 & 1 & 0.4 \\ 0.5 & 0.8 & 1 \end{bmatrix} = [0.6 \quad 1 \quad 0.4]. \quad (5.17)$$

As for the question raised before, suppose that, as in (4.3), we have

$$U = 1 + 2 + 3 + 4 + 5 \quad (5.18)$$

with *small* and *large* defined by (4.2) and (4.7), respectively. Then, substituting *small* for  $A$ , *large* for  $B$  and *not very large* for  $C$  in (5.9), we obtain the relation matrix  $R$  for the fuzzy conditional statement IF *small* THEN *large* ELSE *not very large*. The result of the composition of  $R$  with  $x = \text{very}$

<sup>8</sup> If  $R$  is visualized as a fuzzy graph, then (5.16) may be viewed as the expression for the fuzzy ordinate  $y$  corresponding to a fuzzy abscissa  $x$ .

*small* is

$$\begin{aligned}
 & \begin{matrix} & & & & R \\ & & & & \\ x & & & & \\ [1 & 0.64 & 0.36 & 0.16 & 0.04] \circ \end{matrix} \begin{bmatrix} 0.2 & 0.4 & 0.6 & 0.8 & 1 \\ 0.2 & 0.4 & 0.6 & 0.8 & 0.8 \\ 0.4 & 0.4 & 0.6 & 0.6 & 0.6 \\ 0.6 & 0.6 & 0.6 & 0.4 & 0.4 \\ 0.8 & 0.8 & 0.64 & 0.36 & 0.2 \end{bmatrix} \\
 & \begin{matrix} y \\ = [0.36 & 0.4 & 0.6 & 0.8 & 1]. \end{matrix} \quad (5.19)
 \end{aligned}$$

There are several aspects of (5.16) that are in need of comment. First, it should be noted that when  $R = A \Rightarrow B$  and  $x = A$  we obtain

$$y = A \circ (A \Rightarrow B) = B \quad (5.20)$$

as an exact identity, when  $A$ ,  $B$ , and  $C$  are nonfuzzy, and an approximate one, when  $A$ ,  $B$ , and  $C$  are fuzzy. It is in this sense that the compositional inference rule (5.16) may be viewed as an approximate extension of *modus ponens*. (Note that in consequence of the way in which  $A \Rightarrow B$  is defined in (5.12), the more different  $x$  is from  $A$ , the less sharply defined is  $y$ .)

Second, (5.16) is analogous to the expression for the marginal probability in terms of the conditional probability function; that is

$$r_j = \sum_i q_i p_{ij} \quad (5.21)$$

where

$$\begin{aligned}
 q_i &= \Pr \{X = x_i\} \\
 r_j &= \Pr \{Y = y_j\} \\
 p_{ij} &= \Pr \{Y = y_j \mid X = x_i\}
 \end{aligned}$$

and  $X$  and  $Y$  are random variables with values  $x_1, x_2, \dots$  and  $y_1, y_2, \dots$ , respectively. However, this analogy does not imply that (5.16) is a relation between probabilities.

Third, it should be noted that because of the use of the max-min matrix product in (5.16), the relation between  $x$  and  $y$  is not continuous. Thus, in general, a small change in  $x$  would produce no change in  $y$  until a certain threshold is exceeded. This would not be the case if the composition of  $x$  with  $R$  were defined as max-product composition.

Fourth, in the computation of  $x \circ R$  one may take advantage of the distributivity of composition over the union of fuzzy sets. Thus, if

$$x = u \text{ or } v \quad (5.22)$$

where  $u$  and  $v$  are labels of fuzzy sets, then

$$(u \text{ or } v) \circ R = u \circ R \text{ or } v \circ R. \quad (5.23)$$

For example, if  $x$  is *small or medium*, and  $R = A \Rightarrow B$  reads IF  $x$  is *not small and not large* THEN  $y$  is *very small*, then we can write

$$\begin{aligned}
 & (\textit{small or medium}) \circ (\textit{not small and not large} \Rightarrow \textit{very small}) \\
 & = \textit{small} \circ (\textit{not small and not large} \Rightarrow \textit{very small}) \textit{ or medium} \\
 & \quad \circ (\textit{not small and not large} \Rightarrow \textit{very small}). \quad (5.24)
 \end{aligned}$$

As a final comment, it is important to realize that in practical applications of fuzzy conditional statements to the description of complex or ill-defined relations, the computations involved in (5.9), (5.10), and (5.16) would, in general, be performed in a highly approximate fashion. Furthermore, an additional source of imprecision would be the result of representing a fuzzy set as a value of a linguistic variable. For example, suppose that a relation between fuzzy variables  $x$  and  $y$  is described by the fuzzy conditional statement IF *small* THEN *large* ELSE IF *medium* THEN *medium* ELSE IF *large* THEN *very small*.

Typically, we would assign different linguistic values to  $x$  and compute the corresponding values of  $y$  by the use of (5.16). Then, on approximating to the computed values of  $y$  by linguistic labels, we would arrive at a table having the form shown below:

Given		Inferred	
$A$	$B$	$x$	$y$
<i>small</i>	<i>large</i>	<i>not small</i>	<i>not very large</i>
<i>medium</i>	<i>medium</i>	<i>very small</i>	<i>very very large</i>
<i>large</i>	<i>very small</i>	<i>very very small</i>	<i>very very large</i>
		<i>not very large</i>	<i>small or medium</i>

Such a table constitutes an approximate linguistic characterization of the relation between  $x$  and  $y$  which is inferred from the given fuzzy conditional statement. As was stated earlier, fuzzy conditional statements play a basic role in the description and execution of fuzzy algorithms. We turn to this subject in the following section.

## VI. FUZZY ALGORITHMS

Roughly speaking, a fuzzy algorithm is an ordered set of fuzzy instructions which upon execution yield an approximate solution to a specified problem. In one form or another, fuzzy algorithms pervade much of what we do. Thus, we employ fuzzy algorithms both consciously and subconsciously when we walk, drive a car, search for an object, tie a knot, park a car, cook a meal, find a number in a telephone directory, etc. Furthermore, there are many instances of uses of what, in effect, are fuzzy algorithms in a wide variety of fields, especially in programming, operations research, psychology, management science, and medical diagnosis.

The notion of a fuzzy set and, in particular, the concept of a fuzzy conditional statement provide a basis for using fuzzy algorithms in a more systematic and hence more effective ways than was possible in the past. Thus, fuzzy algorithms could become an important tool for an approximate analysis of systems and decision processes which are much too complex for the application of conventional mathematical techniques.

A formal characterization of the concept of a fuzzy algorithm can be given in terms of the notion of a fuzzy Turing machine or a fuzzy Markoff algorithm [6]–[8]. In this section, the main aim of our discussion is to relate the concept of a fuzzy algorithm to the notions introduced in the preceding sections and illustrate by simple examples some of the uses of such algorithms.

The instructions in a fuzzy algorithm fall into the following three classes.

1) *Assignment Statements*: e.g.,

$x \approx 5$   
 $x = \text{small}$   
 $x$  is large  
 $x$  is not large and not very small.

2) *Fuzzy Conditional Statements*: e.g.,

IF  $x$  is small THEN  $y$  is large ELSE  $y$  is not large  
 IF  $x$  is positive THEN decrease  $y$  slightly  
 IF  $x$  is much greater than 5 THEN stop  
 IF  $x$  is very small THEN go to 7.

Note that in such statements either the antecedent or the consequent or both may be labels of fuzzy sets.

3) *Unconditional Action Statements*: e.g.,

multiply  $x$  by  $x$   
 decrease  $x$  slightly  
 delete the first few occurrences of 1  
 go to 7  
 print  $x$   
 stop.

Note that some of these instructions are fuzzy and some are not.

The combination of an assignment statement and a fuzzy conditional statement is executed in accordance with the compositional rule (5.16). For example, if at some point in the execution of a fuzzy algorithm we encounter the instructions

- 1)  $x = \text{very small}$
- 2) IF  $x$  is small THEN  $y$  is large ELSE  $y$  is not very large

where *small* and *large* are defined by (4.2) and (4.7), then the result of the execution of 1) and 2) will be the value of  $y$  given by (5.19), that is,

$$y = 0.36/1 + 0.4/2 + 0.64/3 + 0.8/4 + 1/5. \quad (6.1)$$

An unconditional but fuzzy action statement is executed similarly. For example, the instruction

$$\text{multiply } x \text{ by itself a few times} \quad (6.2)$$

with *few* defined as

$$\text{few} = 1/1 + 0.8/2 + 0.6/3 + 0.4/4 \quad (6.3)$$

would yield upon execution the fuzzy set

$$y = 1/x^2 + 0.8/x^3 + 0.6/x^4 + 0.4/x^5. \quad (6.4)$$

It is important to observe that, in both (6.1) and (6.4), the result of execution is a fuzzy set rather than a single number. However, when a human subject is presented with a fuzzy instruction such as "take several steps," with *several* defined by (see (2.10))

$$\text{several} = 0.5/3 + 0.8/4 + 1/5 + 1/6 + 0.8/7 + 0.5/8 \quad (6.5)$$

the result of execution must be a single number between 3 and 8. On what basis will such a number be chosen?

As pointed out in [6], it is reasonable to assume that the result of execution will be that element of the fuzzy set which has the highest grade of membership in it. If such an element is not unique, as is true of (6.5), then a random or arbitrary choice can be made among the elements having the highest grade of membership. Alternatively, an external criterion can be introduced which linearly orders those elements of the fuzzy set which have the highest membership, and thus generates a unique greatest element. For example, in the case of (6.5), if the external criterion is to minimize the number of steps that have to be taken, then the subject will pick 5 from the elements with the highest grade of membership.

An analogous question arises in situations in which a human subject has to give a "yes" or "no" answer to a fuzzy question. For example, suppose that a subject is presented with the instruction

$$\text{IF } x \text{ is small THEN stop ELSE go to 7} \quad (6.6)$$

in which *small* is defined by (4.2). Now assume that  $x = 3$ , which has the grade of membership of 0.6 in *small*. Should the subject execute "stop" or "go to 7"? We shall assume that in situations of this kind the subject will pick that alternative which is more true than untrue, e.g., " $x$  is *small*" over " $x$  is not *small*," since in our example the degree of truth of the statement " $3$  is *small*" is 0.6, which is greater than that of the statement " $3$  is not *small*." If both alternatives have more or less equal truth values, the choice can be made arbitrarily. For convenience, we shall refer to this rule of deciding between two alternatives as the *rule of the preponderant alternative*.

It is very important to understand that the questions just discussed arise only in those situations in which the result of execution of a fuzzy instruction is required to be a single element (e.g., a number) rather than a fuzzy set. Thus, if we allowed the result of execution of (6.6) to be fuzzy, then for  $x = 3$  we would obtain the fuzzy set

$$0.6/\text{stop} + 0.4/\text{go to 7}$$

which implies that the execution is carried out in parallel. The assumption of parallelism is implicit in the compositional rule of inference and is basic to the understanding of fuzzy algorithms and their execution by humans and machines.

In what follows, we shall present several examples of fuzzy algorithms in the light of the concepts discussed in the preceding sections. It should be stressed that these examples are intended primarily to illustrate the basic aspects of fuzzy algorithms rather than demonstrate their effectiveness in the solution of practical problems.

It is convenient to classify fuzzy algorithms into several basic categories, each corresponding to a particular type of application: definitional and identificational algorithms; generational algorithms; relational and behavioral algorithms; and decisional algorithms. (It should be noted that an algorithm of a particular type can include algorithms of other types as subalgorithms. For example, a definitional algorithm may contain relational and decisional sub-

algorithms.) We begin with an example of a definitional algorithm.

### Fuzzy Definitional Algorithms

One of the basic areas of application for fuzzy algorithms lies in the definition of complex, ill-defined or fuzzy concepts in terms of simpler or less fuzzy concepts. The following are examples of such fuzzy concepts: sparseness of matrices; handwritten characters; measures of complexity; measures of proximity or resemblance; degrees of clustering; criteria of performance; soft constraints; rules of various kinds, e.g., zoning regulations; legal criteria, e.g., criteria for insanity, obscenity, etc.; and fuzzy diseases such as arthritis, arteriosclerosis, schizophrenia.

Since a fuzzy concept may be viewed as a label for a fuzzy set, a *fuzzy definitional algorithm* is, in effect, a finite set of possibly fuzzy instructions which define a fuzzy set in terms of other fuzzy sets (and possibly itself, i.e., recursively) or constitute a procedure for computing the grade of membership of any element of the universe of discourse in the set under definition. In the latter case, the definitional algorithm plays the role of an *identificational algorithm*, that is, an algorithm which identifies whether or not an element belongs to a set or, more generally, determines its grade of membership. An example of such an algorithm is provided by the procedure (see [5]) for computing the grade of membership of a string in a fuzzy language generated by a context-free grammar.

As a very simple example of a fuzzy definitional algorithm, we shall consider the fuzzy concept *oval*. It should be emphasized again that the oversimplified definition that will be given is intended only for illustrative purposes and has no pretense at being an accurate definition of the concept *oval*. The instructions comprising the algorithm OVAL are listed here. The symbol  $T$  in these instructions stands for the object under test. The term CALL CONVEX represents a call on a subalgorithm labeled CONVEX, which is a definitional algorithm for testing whether or not  $T$  is convex. An instruction of the form IF  $A$  THEN  $B$  should be interpreted as IF  $A$  THEN  $B$  ELSE go to next instruction.

#### Algorithm OVAL:

- 1) IF  $T$  is not closed THEN  $T$  is not *oval*; stop.
- 2) IF  $T$  is self-intersecting THEN  $T$  is not *oval*; stop.
- 3) IF  $T$  is not CALL CONVEX THEN  $T$  is not *oval*; stop.
- 4) IF  $T$  does not have two *more or less* orthogonal axes of symmetry THEN  $T$  is not *oval*; stop.
- 5) IF the major axis of  $T$  is not *much* longer than the minor axis THEN  $T$  is not *oval*; stop.
- 6)  $T$  is *oval*; stop.

*Subalgorithm CONVEX:* Basically, this subalgorithm involves a check on whether the curvature of  $T$  at each point maintains the same sign as one moves along  $T$  in some initially chosen direction.

- 1)  $x = a$  (some initial point on  $T$ ).
- 2) Choose a direction of movement along  $T$ .
- 3)  $t \approx$  direction of tangent to  $T$  at  $x$ .

- 4)  $x' \approx x + 1$  (move from  $x$  to a neighboring point).
- 5)  $t' \approx$  direction of tangent to  $T$  at  $x'$ .
- 6)  $\alpha \approx$  angle between  $t'$  and  $t$ .
- 7)  $x \approx x'$ .
- 8)  $t \approx$  direction of tangent to  $T$  at  $x$ .
- 9)  $x' \approx x + 1$ .
- 10)  $t' \approx$  direction of tangent to  $T$  at  $x'$ .
- 11)  $\beta \approx$  angle between  $t'$  and  $t$ .
- 12) IF  $\beta$  does not have the same sign as  $\alpha$  THEN  $T$  is not convex; return.
- 13) IF  $x' \approx a$  THEN  $T$  is convex; return.
- 14) Go to 7).

*Comment:* It should be noted that the first three instructions in OVAL are nonfuzzy. As for instructions 4) and 5), they involve definitions of concepts such as "*more or less* orthogonal," and "*much* longer," which, though fuzzy, are less complex and better understood than the concept of *oval*. This exemplifies the main function of a fuzzy definitional algorithm, namely, to reduce a new or complex fuzzy concept to simpler or better understood fuzzy concepts. In a more elaborate version of the algorithm OVAL, the answers to 4) and 5) could be the degrees to which the conditions in these instructions are satisfied. The final result of the algorithm, then, would be the grade of membership of  $T$  in the fuzzy set of oval objects.

In this connection, it should be noted that, in virtue of (5.15), the algorithm OVAL as stated is approximately equivalent to the expression

$$\begin{aligned} oval = & \text{closed} \cap \text{non-self-intersecting} \cap \text{convex} \\ & \cap \text{more or less orthogonal axes of symmetry} \\ & \cap \text{major axis much larger than minor axis} \quad (6.7) \end{aligned}$$

which defines the fuzzy set *oval* as the intersection of the fuzzy and nonfuzzy sets whose labels appear on the right-hand side of (6.7). However, one significant difference is that the algorithm not only defines the right-hand side of (6.7), but also specifies the order in which the computations implicit in (6.7) are to be performed.

### Fuzzy Generational Algorithms

As its designation implies, a fuzzy generational algorithm serves to generate rather than define a fuzzy set. Possible applications of generational algorithms include: generation of handwritten characters and patterns of various kinds; cooking recipes; generation of music; generation of sentences in a natural language; generation of speech.

As a simple illustration of the notion of a generational algorithm, we shall consider an algorithm for generating the letter  $\mathbf{P}$ , with the height  $h$  and the base  $b$  of  $\mathbf{P}$  constituting the parameters of the algorithm. For simplicity,  $\mathbf{P}$  will be generated as a dotted pattern, with eight dots lying on the vertical line.

#### Algorithm $\mathbf{P}(h,b)$ :

- 1)  $i = 1$ .
- 2)  $X(i) = b$  (first dot at base).

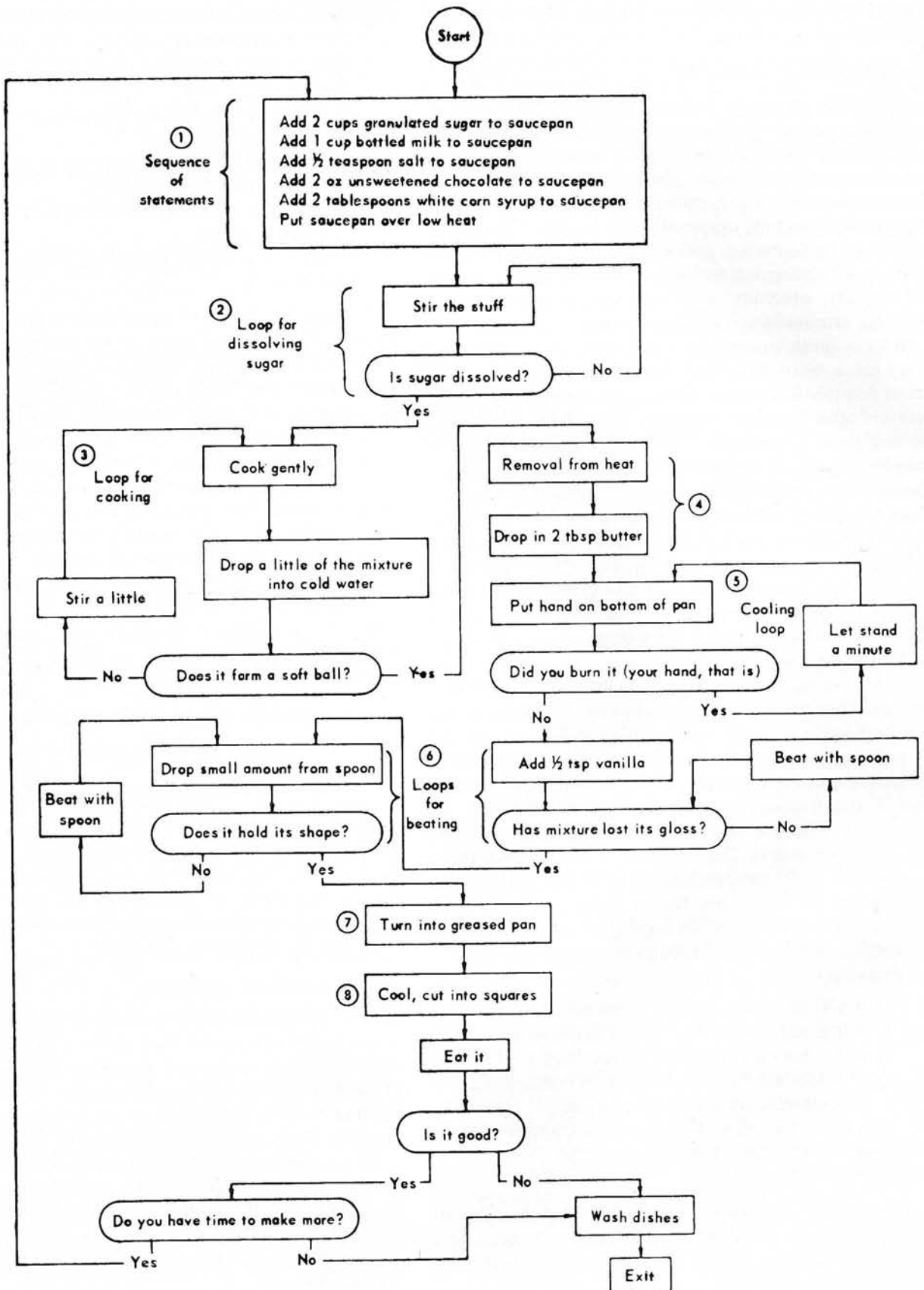

Fig. 3. Recipe for chocolate fudge (from [19]).

- 3)  $X(i + 1) \approx X(i) + h/6$  (put dot *approximately*  $h/6$  units of distance above  $X(i)$ ).
- 4)  $i = i + 1$ .
- 5) IF  $i = 7$  THEN make right turn and go to 7).
- 6) Go to 3.
- 7) Move by  $h/6$  units; put a dot.
- 8) Turn by  $45^\circ$ ; move by  $h/6$  units; put a dot.
- 9) Turn by  $45^\circ$ ; move by  $h/6$  units; put a dot.
- 10) Turn by  $45^\circ$ ; move by  $h/6$  units; put a dot.
- 11) Turn by  $45^\circ$ ; move by  $h/6$  units; put a dot; stop.

The algorithm as stated is of open-loop type in the sense that it does not incorporate any feedback. To make the algorithm less sensitive to errors in execution, we could introduce fuzzy feedback by conditioning the termination of the algorithm on an approximate satisfaction of a specified test. For example, if the last point in step 11) does not fall on the vertical part of  $P$ , we could return to step 8) and either reduce or increase the angle of turn in steps 8)–11) to correct for the terminal error. The flowchart of a cooking recipe for chocolate fudge (Fig. 3), which is reproduced from [19], is a good example of what, in effect, is a fuzzy generational algorithm with feedback.

*Fuzzy Relational and Behavioral Algorithms*

A *fuzzy relational algorithm* serves to describe a relation or relations between fuzzy variables. A relational algorithm which is used for the specific purpose of approximate description of the behavior of a system will be referred to as a *fuzzy behavioral algorithm*.

A simple example of a relational algorithm labeled  $R$  which involves three parameters  $x$ ,  $y$ , and  $z$  is given. This algorithm defines a fuzzy ternary relation  $R$  in the universe of discourse  $U = 1 + 2 + 3 + 4 + 5$  with *small* and *large* defined by (4.2) and (4.7).

*Algorithm R(x,y,z):*

- 1) IF  $x$  is *small* and  $y$  is *large* THEN  $z$  is *very small* ELSE  $z$  is *not small*.
- 2) IF  $x$  is *large* THEN (IF  $y$  is *small* THEN  $z$  is *very large* ELSE  $z$  is *small*) ELSE  $z$  and  $y$  are *very very small*.

If needed, the meaning of these conditional statements can be computed by using (5.9) and (5.11). The relation  $R$ , then, will be the intersection of the relations defined by instructions 1) and 2).

Another simple example of a relational fuzzy algorithm  $F(x,y)$  which illustrates a different aspect of such algorithms is the following.

*Algorithm F(x,y):*

- 1) IF  $x$  is *small* and  $x$  is increased *slightly* THEN  $y$  will increase *slightly*.
- 2) IF  $x$  is *small* and  $x$  is increased *substantially* THEN  $y$  will increase *substantially*.
- 3) IF  $x$  is *large* and  $x$  is increased *slightly* THEN  $y$  will increase *moderately*.
- 4) IF  $x$  is *large* and  $x$  is increased *substantially* THEN  $y$  will increase *very substantially*.

As in the case of the previous example, the meaning of the fuzzy conditional statements in this algorithm can be computed by the use of the methods discussed in Sections IV and V if one is given the definitions of the primary terms *large* and *small* as well as the hedges *slightly*, *substantially*, and *moderately*.

As a simple example of a behavioral algorithm, suppose that we have a system  $S$  with two nonfuzzy states (see [3]) labeled  $q_1$  and  $q_2$ , two fuzzy input values labeled *low* and *high*, and two fuzzy output values labeled *large* and *small*. The universe of discourse for the input and output values is assumed to be the real line. We assume further that the behavior of  $S$  can be characterized in an approximate fashion by the algorithm that will be given. However, to represent the relations between the inputs, states, and outputs, we use the conventional state transition tables instead of conditional statements.

*Algorithm BEHAVIOR:*

		$x_{t+1}$		$y_t$	
$u_t$	$x_t$	$q_1$	$q_2$	$q_1$	$q_2$
	<i>low</i>	$q_2$	$q_1$	<i>large</i>	<i>small</i>
	<i>high</i>	$q_1$	$q_1$	<i>small</i>	<i>large</i>

where

- $u_t$  input at time  $t$
- $y_t$  output at time  $t$
- $x_t$  state at time  $t$ .

On the surface, this table appears to define a conventional nonfuzzy finite-state system. What is important to recognize, however, is that in the case of the system under consideration the inputs and outputs are fuzzy subsets of the real line. Thus we could pose the question: What would be the output of  $S$  if it is in state  $q_1$  and the applied input is *very low*? In the case of  $S$ , this question can be answered by an application of the compositional inference rule (5.16). On the other hand, the same question would not be a meaningful one if  $S$  is assumed to be a nonfuzzy finite-state system characterized by the preceding table.

Behavioral fuzzy algorithms can also be used to describe the more complex forms of behavior resulting from the presence of random elements in a system. For example, the presence of random elements in  $S$  might result in the following fuzzy-probabilistic characterization of its behavior:

		$x_{t+1}$		$y_t$	
$u_t$	$x_t$	$q_1$	$q_2$	$q_1$	$q_2$
	<i>low</i>	$q_2$ likely	$q_1$ likely	<i>large</i> likely	<i>small</i> likely <sup>2</sup>
	<i>high</i>	$q_1$ likely <sup>2</sup>	$q_1$ unlikely <sup>2</sup>	<i>small</i> likely <sup>2</sup>	<i>large</i> unlikely <sup>2</sup>

In this table, the term *likely* and its modifications by *very* and *not* serve to provide an approximate characterization of probabilities. For example, IF the input is *low* and the present state is  $q_1$ , THEN the next state is *likely* to be  $q_2$ . Similarly, IF the input is *high* and the present state is  $q_2$  THEN the output is *very unlikely* to be *large*. If the meaning

of *likely* is defined by (see (4.16))

$$likely = 1/1 + 1/0.9 + 1/0.8 + 0.8/0.7 + 0.6/0.6 + 0.5/0.5 + 0.3/0.4 + 0.2/0.3 \quad (6.8)$$

then

$$unlikely = 0.2/0.7 + 0.4/0.6 + 0.5/0.5 + 0.7/0.4 + 0.8/0.3 + 1/0.2 + 1/0.1 + 1/0 \quad (6.9)$$

$$very\ likely \approx 1/1 + 1/0.9 + 1/0.8 + 0.6/0.7 + 0.4/0.6 + 0.3/0.5 + 0.1/0.4 \quad (6.10)$$

$$very\ unlikely \approx 0.2/0.6 + 0.3/0.5 + 0.5/0.4 + 0.6/0.3 + 1/0.2 + 1/0.1 + 1/0. \quad (6.11)$$

### Fuzzy Decisional Algorithms

A *fuzzy decisional algorithm* is a fuzzy algorithm which serves to provide an approximate description of a strategy or decision rule. Commonplace examples of such algorithms, which we use for the most part on a subconscious level, are the algorithms for parking a car, crossing an intersection, transferring an object, buying a house, etc.

To illustrate the notion of a fuzzy decisional algorithm, we shall consider two simple examples drawn from our everyday experiences.

*Example—Crossing a traffic intersection:* It is convenient to break down the algorithm in question into several subalgorithms, each of which applies to a particular type of intersection. For our purposes, it will be sufficient to describe only one of these subalgorithms, namely, the subalgorithm SIGN, which is used when the intersection has a stop sign. As in the case of other examples in this section, we shall make a number of simplifying assumptions in order to shorten the description of the algorithm.

#### Algorithm INTERSECTION:

- 1) IF signal lights THEN CALL SIGNAL ELSE IF stop sign THEN CALL SIGN ELSE IF blinking light THEN CALL BLINKING ELSE CALL UNCONTROLLED.

#### Subalgorithm SIGN:

- 1) IF no stop sign on your side THEN IF no cars in the intersection THEN cross at *normal* speed ELSE wait for cars to leave the intersection and then cross.
- 2) IF not *close* to intersection THEN continue approaching at normal speed for a *few* seconds; go to 2).
- 3) *Slow down.*
- 4) IF in a *great* hurry and no police cars in sight and no cars in the intersection or its *vicinity* THEN cross the intersection at *slow* speed.
- 5) IF *very close* to intersection THEN stop; go to 7).
- 6) Continue *approaching* at *very slow* speed; go to 5).
- 7) IF no cars *approaching* or in the intersection THEN cross.
- 8) Wait a *few* seconds; go to 7).

It hardly needs saying that a realistic version of this algorithm would be considerably more complex. The im-

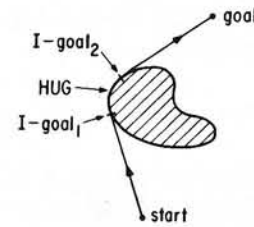

Fig. 4. Problem of transferring blindfolded subject from *start* to *goal*.

portant point of the example is that such an algorithm could be constructed along the same lines as the highly simplified version just described. Furthermore, it shows that a fuzzy algorithm could serve as an effective means of communicating know-how and experience.

As a final example, we consider a decisional algorithm for transferring a blindfolded subject *H* from an initial position *start* to a final position *goal* under the assumption that there may be an obstacle lying between *start* and *goal* (see Fig. 4). (Highly sophisticated nonfuzzy algorithms of this type for use by robots are incorporated in Shakey, the robot built by the Artificial Intelligence Group at Stanford Research Institute. A description of this robot is given in [20].)

The algorithm, labeled OBSTACLE, is assumed to be used by a human controller *C* who can observe the way in which *H* executes his instructions. This fuzzy feedback plays an essential role in making it possible for *C* to direct *H* to *goal* in spite of the fuzziness of instructions as well as the errors in their execution by *H*. The algorithm OBSTACLE consists of three subalgorithms: ALIGN, HUG, and STRAIGHT. The function of STRAIGHT is to transfer *H* from *start* to an intermediate goal *I-goal1*, and then from *I-goal2* to *goal*. (See Fig. 4.) The function of ALIGN is to orient *H* in a desired direction; the function of HUG is to guide *H* along the boundary of the obstacle until the goal is no longer obstructed.

Instead of describing these subalgorithms in terms of fuzzy conditional statements as we have done in previous examples, it is instructive to convey the same information by flowcharts, as shown in Figs. 5–7. In the flowchart of ALIGN,  $\epsilon$  denotes the error in alignment, and we assume for simplicity that  $\epsilon$  has a constant sign. The flowcharts of HUG and STRAIGHT are self-explanatory. Expressed in terms of fuzzy conditional statements, the flowchart of STRAIGHT, for example, translates into the following instructions.

#### Subalgorithm STRAIGHT:

- 1) IF not *close* THEN take a step; go to 1).
- 2) IF not *very close* THEN take a *small* step; go to 2).
- 3) IF not *very very close* THEN take a *very small* step; go to 3).
- 4) Stop.

### VII. CONCLUDING REMARKS

In this and the preceding sections of this paper, we have attempted to develop a conceptual framework for dealing



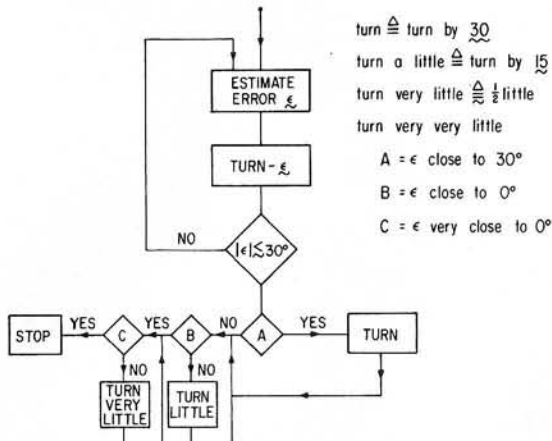

Fig. 5. Subalgorithm ALIGN.

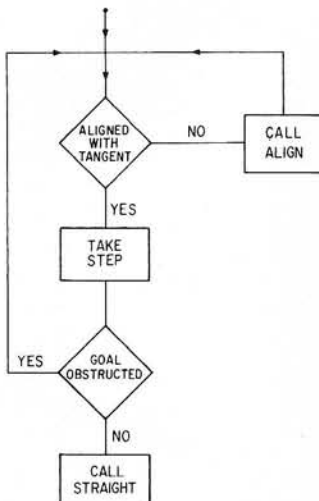

Fig. 6. Subalgorithm HUG.

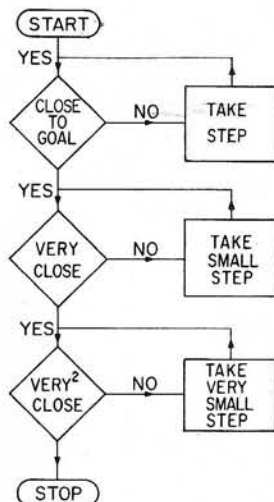

Fig. 7. Subalgorithm STRAIGHT.

with systems which are too complex or too ill-defined to admit of precise quantitative analysis. What we have done should be viewed, of course, as merely a first tentative step in this direction. Clearly, there are many basic as well as detailed aspects of our approach which we have treated incompletely, if at all. Among these are questions relating to the role of fuzzy feedback in: the execution of fuzzy algorithms; the execution of fuzzy algorithms by humans; the conjunction of fuzzy instructions; the assessment of the goodness of fuzzy algorithms; the implications of the compositional rule of inference and the rule of the preponderant alternative; and the interplay between fuzziness and probability in the behavior of humanistic systems.

Nevertheless, even at its present stage of development, the method described in this paper can be applied rather effectively to the formulation and approximate solution of a wide variety of practical problems, particularly in such fields as economics, management science, psychology, linguistics, taxonomy, artificial intelligence, information retrieval, medicine, and biology. This is particularly true of those problem areas in these fields in which fuzzy algorithms can be drawn upon to provide a means of description of ill-defined concepts, relations, and decision rules.

## REFERENCES

- [1] L. A. Zadeh, "Fuzzy sets," *Inform. Contr.*, vol. 8, pp. 338-353, 1965.
- [2] —, "Similarity relations and fuzzy orderings," *Inform. Sci.*, vol. 3, pp. 177-200, 1971.
- [3] —, "Toward a theory of fuzzy systems," in *Aspects of Network and System Theory*, R. E. Kalman and N. DeClaris, Eds. New York: Holt, Rinehart and Winston, 1971.
- [4] —, "Quantitative fuzzy semantics," *Inform. Sci.*, vol. 3, pp. 159-176, 1971.
- [5] —, "Fuzzy languages and their relation to human and machine intelligence," in *Proc. Conf. Man and Computer*, 1970; also *Electron. Res. Lab., Univ. California, Berkeley, Memo. M-302*, 1971.
- [6] —, "Fuzzy algorithms," *Inform. Contr.*, vol. 12, pp. 94-102, 1968.
- [7] E. Santos, "Fuzzy algorithms," *Inform. Contr.*, vol. 17, pp. 326-339, 1970.
- [8] L. A. Zadeh, "On fuzzy algorithms," *Electron. Res. Lab., Univ. California, Berkeley, Memo. M-325*, 1971.
- [9] S.-K. Chang, "On the execution of fuzzy programs using finite-state machines," *IEEE Trans. Comput.*, vol. C-21, pp. 241-253, Mar. 1972.
- [10] S. S. L. Chang and L. A. Zadeh, "Fuzzy mapping and control," *IEEE Trans. Syst., Man, Cybern.*, vol. SMC-2, pp. 30-34, Jan. 1962.
- [11] R. E. Bellman and L. A. Zadeh, "Decision-making in a fuzzy environment," *Management Sci.*, vol. 17, pp. B-141-B-164, 1970.
- [12] J. A. Goguen, "The logic of inexact concepts," *Syn.*, vol. 19, pp. 325-373, 1969.
- [13] G. Lakoff, "Hedges: a study in meaning criteria and the logic of fuzzy concepts," in *Proc. 8th Reg. Meet. Chicago Linguist. Soc.*, 1972.
- [14] L. A. Zadeh, "A system-theoretic view of behavior modification," *Electron. Res. Lab., Univ. California, Berkeley, Memo. M-320*, 1972.
- [15] —, "A fuzzy-set-theoretic interpretation of hedges," *Electron. Res. Lab., Univ. California, Berkeley, Memo. M-335*, 1972.
- [16] A. De Luca and S. Termini, "A definition of a non-probabilistic entropy in the setting of fuzzy sets theory," *Inform. Contr.*, vol. 20, pp. 301-312, 1972.
- [17] R. C. T. Lee, "Fuzzy logic and the resolution principle," *J. Ass. Comput. Mach.*, vol. 19, pp. 109-119, 1972.
- [18] G. E. Hughes and M. J. Cresswell, *An Introduction to Modal Logic*. London: Methuen, 1968.
- [19] R. S. Ledley, *Fortran IV Programming*. New York: McGraw-Hill, 1966.
- [20] B. Raphael, R. Duda, R. E. Fikes, P. E. Hart, N. Nilsson, P. W. Thorndyke, and B. M. Wilbur, "Research and applications—artificial intelligence," *Stanford Res. Inst., Menlo Park, Calif., Final Rep.*, Oct. 1971.