

We are IntechOpen, the world's leading publisher of Open Access books Built by scientists, for scientists

4,500

Open access books available

118,000

International authors and editors

130M

Downloads

Our authors are among the

154

Countries delivered to

TOP 1%

most cited scientists

12.2%

Contributors from top 500 universities



WEB OF SCIENCE™

Selection of our books indexed in the Book Citation Index
in Web of Science™ Core Collection (BKCI)

Interested in publishing with us?
Contact book.department@intechopen.com

Numbers displayed above are based on latest data collected.
For more information visit www.intechopen.com



Use of Heat Transfer Enhancement Techniques in the Design of Heat Exchangers

Martín Picón-Núñez, Jorge C. Melo-González and Jorge Luis García-Castillo

Additional information is available at the end of the chapter

<http://dx.doi.org/10.5772/intechopen.78953>

Abstract

Heat transfer enhancement refers to application of basic concepts of heat transfer processes to improve the rate of heat removal or deposition on a surface. In the flow of a clean fluid through the tube of a heat exchanger, the boundary layer theorem establishes that a laminar sublayer exists where the fluid velocity is minimal. Heat transfer through this stagnant layer is mainly dominated by thermal conduction, becoming the major resistance to heat transfer. From an engineering point of view, heat transfer can be enhanced if this stagnant layer is partially removed or eliminated. In single-phase heat transfer processes, three options are available to increase the heat transfer rate. One of them is the choice of smaller free flow sectional area for increased fluid velocity bringing about a reduction of the thickness of the laminar sublayer. A second option is the engineering of new surfaces which cause increased local turbulence, and the third option consists in the use of mechanical inserts that promote local turbulence. The application of these alternatives is limited by the pressure drop. This chapter describes the concept of heat transfer enhancement and the ways it is applied to the development of new heat exchanger technology.

Keywords: heat transfer enhancement, compact surfaces, turbulence promoters, pressure drop, thermohydraulic performance

1. Introduction

Growing interest in thermal energy recovery in the process industry has driven the development of new heat exchanger technology by means of heat transfer enhancement techniques. Heat transfer enhancement techniques can be as basic as the manipulation of the fluid velocity

inside the unit or as complex as the design of new surface geometries or the design of inserts in the case of tubular geometries.

One of common classifications of heat exchangers is based on the level of compactness that refers to how much heat transfer surface area (m^2) a heat exchanger fits within a unit volume (m^3). In this regard, heat exchangers are classified into compact and noncompact. For instance, tubular heat exchangers such as the shell and tube type are considered within the non-compact technology.

Compact heat exchangers are characterized by a high level of heat transfer enhancement due to their geometrical features and particularly the shape of their heat transfer surfaces that maximize the heat transfer rate by the generation of local turbulence at the expense of increased pressure drop [1]. On the other hand, heat transfer enhancement techniques applied to tubular heat exchangers seek to promote local turbulence by mechanical means [2].

From the thermohydraulic point of view, the main objectives that new exchanger technology must fulfill are:

1. Smaller required heat transfer area and volume for the same heat duty and pressure drop consumption.
2. Increased heat load for the same installed heat transfer area within the limitations imposed by the permitted pressure drop.

For these objectives to be met, it follows that any heat transfer enhancement technique must improve on the heat transfer coefficient and bring about a reduction in the heat transfer area for the same heat duty in a new design. Alternatively, in existing exchangers, enhanced techniques will increase their heat transfer capacity. Heat transfer enhancement techniques are classified into two main groups: active and passive. Active methods require external power, for instance, fluid suction or injection, surface fluid vibrations, etc. Passive methods consist in the modification of the heat transfer surface of the system. The main feature of such devices is that they reduce the laminar boundary layer next to the walls which is the major resistance to heat transfer. In the case of tubular exchangers, passive enhancing methods involve the use of turbulence promoters. Due to its effectiveness, low cost, simple installation and removal for cleaning, availability in almost any material of construction and reliability, such option has become a key heat transfer enhancement technique in recent years. Additionally, tube inserts have proved effective in fouling mitigation in applications with fluids with a high tendency to foul.

This chapter will focus on the various ways heat transfer is enhanced and gives birth to new exchanger technology, either in the way of new compact exchanger technology or in the way of internal inserts to be used in conventional tubular technology.

2. Fluid velocity and heat transfer enhancement

In heat exchanger design or retrofit, fluid velocity can be increased through the choice of reduced free flow area or sectional area. Another option available in design is the choice of the number of passes. In an existing unit, any change to the geometry is referred to as retrofit.

As mentioned earlier, the increase of fluid velocity brings about a reduction of the thickness of the laminar sublayer which in turn results in increased heat transfer coefficients. For the case of tubular heat exchangers, the heat transfer coefficient on the tube and shell side follow the expression of the form:

$$h_t = K_t v_t^{0.8} \quad (1)$$

$$h_s = K_s v_s^{0.6} \quad (2)$$

where h_t and h_s are the tube side and shell side heat transfer coefficients; v_t and v_s are the tube side and shell side mass flow rates; K_t and K_s are parameters that involve geometrical features and physical properties. The change in heat transfer coefficient with increased velocity for the tube side can be calculated from:

$$\frac{h_t^N}{h_t^0} = (F_t)^{0.8} \quad (3)$$

$$F_t = \frac{v_t^N}{v_t^0} \quad (4)$$

where v_t^N and v_t^0 are the fluid velocities at the new and original conditions, respectively. A similar expression can be derived for the case of the shell side. The thermal behavior of the exchanger with velocity is limited by the hydraulic behavior of the unit represented by the increase of the pressure drop. It can be demonstrated that for the tube side, the way pressure drop varies with velocity is expressed as:

$$\Delta P_t = K_{pt} v_t^{1.9} \quad (5)$$

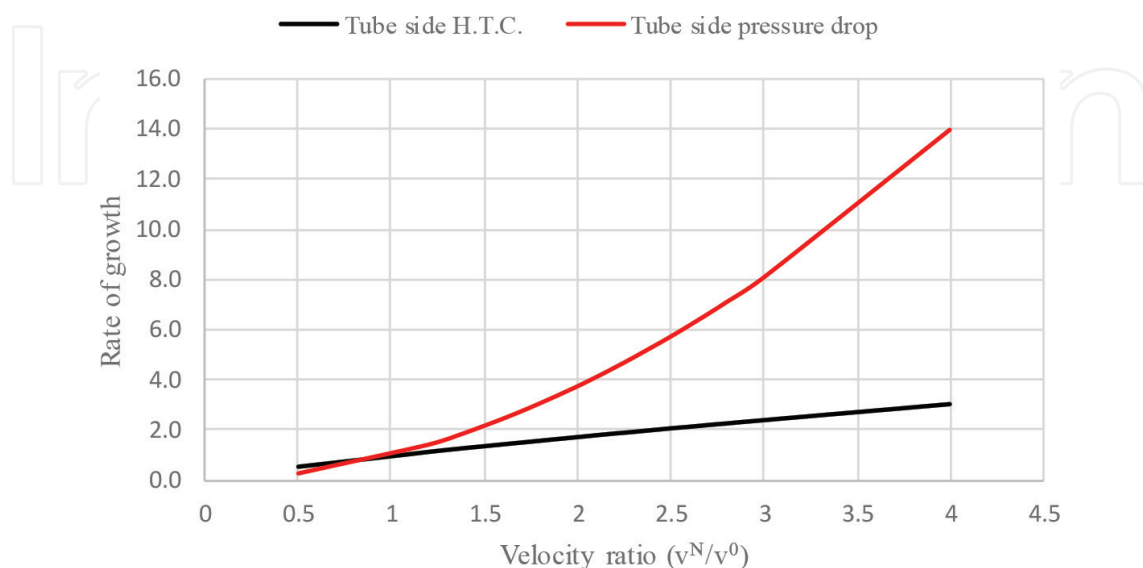

Figure 1. Rate of growth of the heat transfer coefficient and pressure drop on the tube side for a range of velocity increase ratios.

Therefore, the change in pressure drop with velocity can be approximated by:

$$\frac{\Delta P_t^N}{\Delta P_t^0} = (F_t)^{1.9} \quad (6)$$

where ΔP_t^N and ΔP_t^0 are the new pressure drop and the original pressure drop. Expressions (3) and (6) indicate that the pressure drop grows faster with velocity than the heat transfer coefficient does as shown in **Figure 1**.

Although velocity is a simple way of enhancing the heat transfer performance of a heat exchanger, the main problem associated with its manipulation is that the rate at which pressure drop grows establishes a limit. Therefore, in any retrofit or design approach, the allowable pressure drop determines how much heat transfer intensification can be achieved.

3. Heat transfer surface design

For the same bulk fluid velocity, the surface geometry becomes an alternative design option for improving the thermohydraulic performance of a heat exchanger. Examples of modified surfaces used in tubular heat exchangers are the twisted tube exchanger (**Figure 2**). The swirl flow motion creates a constant removal of the laminar layer, thus increasing the heat transfer coefficient with minimal increase of the pressure drop. This geometry involves both the internal and the external fluid.

In operation, the shell side of conventional heat exchangers represents an important area of opportunity for improvement. Heat transfer dampening due to the creation of stagnant zones and high pressure drop due to abrupt changes of direction can be avoided using helical baffles. Helical baffle heat exchangers exhibit a more uniform flow distribution on the shell side compared to conventional shell and tube exchangers for the same pressure drop [3]. They can also reduce tube vibrations and fouling. Their manufacturing costs are higher, but they require less maintenance and their operating costs are lower which so in the long term the investment pays-off [4]. The geometrical features (**Figure 3**) that define this type of technology

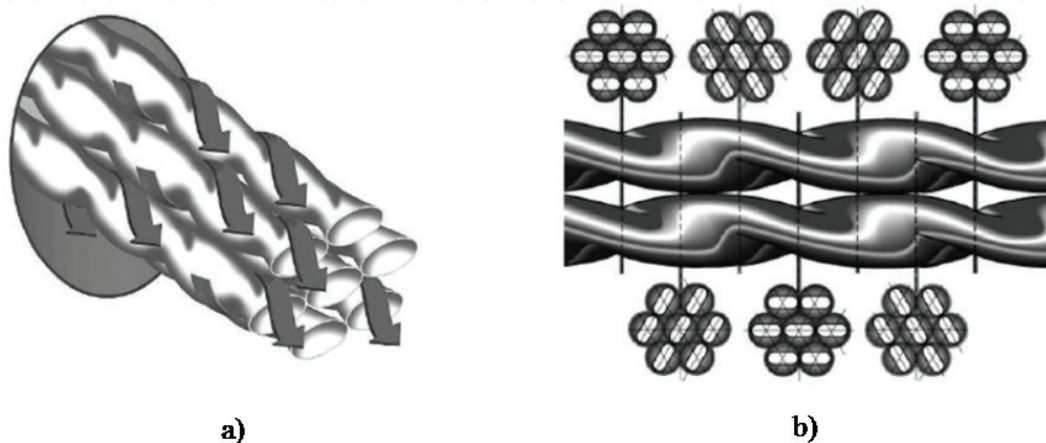

Figure 2. (a) Twisted tube heat exchanger technology; and (b) twisted tube construction.

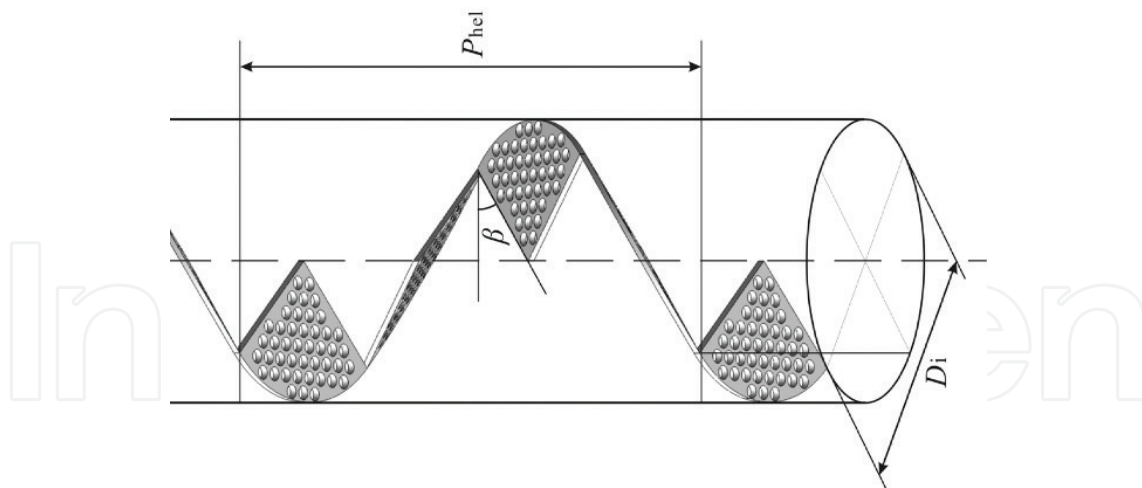

Figure 3. Main geometrical features of a helical heat exchanger.

are: helical pitch, P_{hel} (distance between two consecutive baffles); the helical angle, β (the angle formed between the helix and the vertical); and the shell diameter, D_i , [5].

In [5], it has been demonstrated that the highest thermal performance in this type of geometry is achieved when the baffle angle is 40° . Numerical studies in 3D [3] indicate that the heat transfer rates in helical baffle exchangers are higher than in conventional segmental baffle exchangers from 9 to 23%. Other design alternatives include the use of multiple shell passes [6]. The improved performance of these types of units has also been demonstrated experimentally as reported in [5]. There is little information about expressions to estimate the thermo-hydraulic performance of helical exchangers and the few expressions available are reported for ideal flow conditions and for design purposes correction factor must be applied. In recent work [7], heat transfer and friction factor expressions derived from experimental data have been reported for different helix angles.

Helical-baffle heat exchangers exhibit superior performance compared to conventional segmental baffle exchangers. In [8], a short-cut design approach for helical baffle heat exchangers based on the concept of full use of available pressure drop was developed. The application of this design methodology indicates that improved designs are possible with helical baffle exchangers. For the same heat duty and pressure drop consumption, a reduction of almost 30% in surface area is obtained.

In the search for improved thermal surface performance, heat exchangers have evolved to what are called compact heat exchangers. A large variety of new surface designs are available. The main feature of these technologies is that for the same pressure drop, they create higher heat transfer coefficients. Some of the most common types of compact heat exchangers are described below.

3.1. Plate and fin heat exchangers

A plate and fin heat exchanger is a type compact heat exchanger that is mainly used in gas to gas applications. It consists of a stack of alternate plates called parting sheets and corrugated fins brazed together as a block as shown in **Figure 4**.

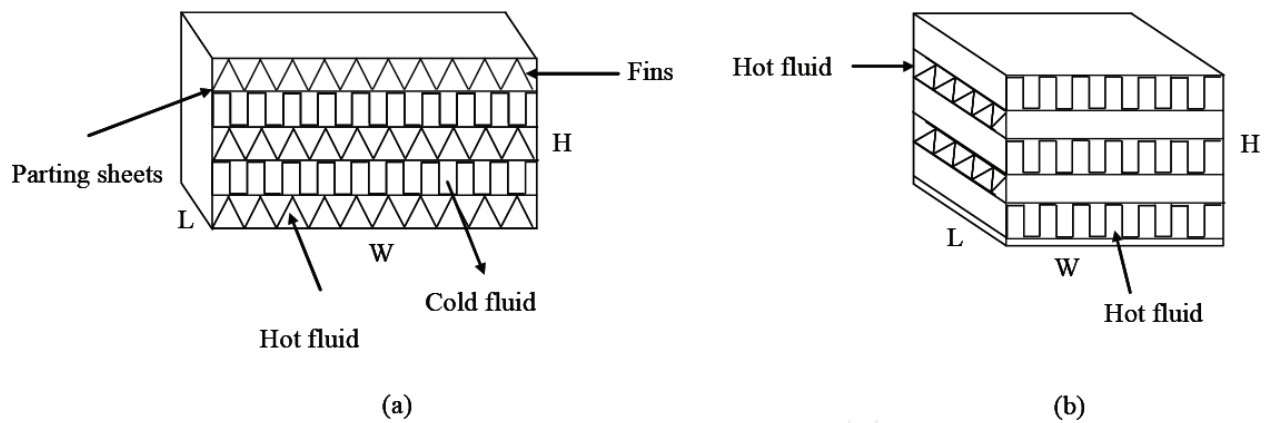

Figure 4. Plate and fin heat exchanger: (a) counter flow arrangement and (b) cross flow arrangement.

Streams exchange heat as they flow through the passages created between the fins and the parting sheets. The fins serve two main functions: a thermal function by increasing the total surface area for heat transfer and a mechanical function by providing mechanical support between layers.

Overall, the design of a heat exchanger requires the specification of the heat duty, stream allowable pressure drops, and certain aspects of exchanger geometry. In the case of plate and fin exchangers, it is fundamental to define the type of the specific secondary surfaces to be employed along with its geometrical features.

The principal geometrical features of a plate and fin exchanger are: ratio of total surface area of one side of the exchanger to volume between plates (β_s), plate spacing (δ), ratio of secondary surface area to total surface area (f_s), hydraulic diameter (d_h), fin thickness (τ), and fin thermal conductivity (k). There are several different types of fins available for design [9]. Among them are: (a) plain-fin, (b) perforated-fin, (c) offset-fin, and (d) wavy (Figure 5).

3.2. Plate and frame heat exchangers

Plate and frame heat exchangers (PFHE) are becoming a suitable alternative to shell and tube exchangers in some applications in the process industries. Their construction with characteristics that facilitate the increase of surface area and their versatility in terms of the materials of construction are some of the reason why in some applications they are the best option. This technology encounters applicability limitations in situations with high pressure and temperature exist or and in cases with a large difference in operating pressure between streams since this can cause plate deformations [1, 10]. This technology is also limited in cases with dirty fluids as their small free flow area is prone to passages clogging.

Plate and frame heat exchangers are formed by a series of corrugated plates that are stacked in a frame; one end of the frame is fixed and the other end is movable to allow the addition or removal of plates. The plates are mounted on the frame by means of upper and lower guiding bars and supported by fastening bolts. The space between plates is sealed by means of polymer gaskets. With PFHE, the need for distribution headers is eliminated since ports are an essential element of the plate design and are incorporated into it. The geometry of a

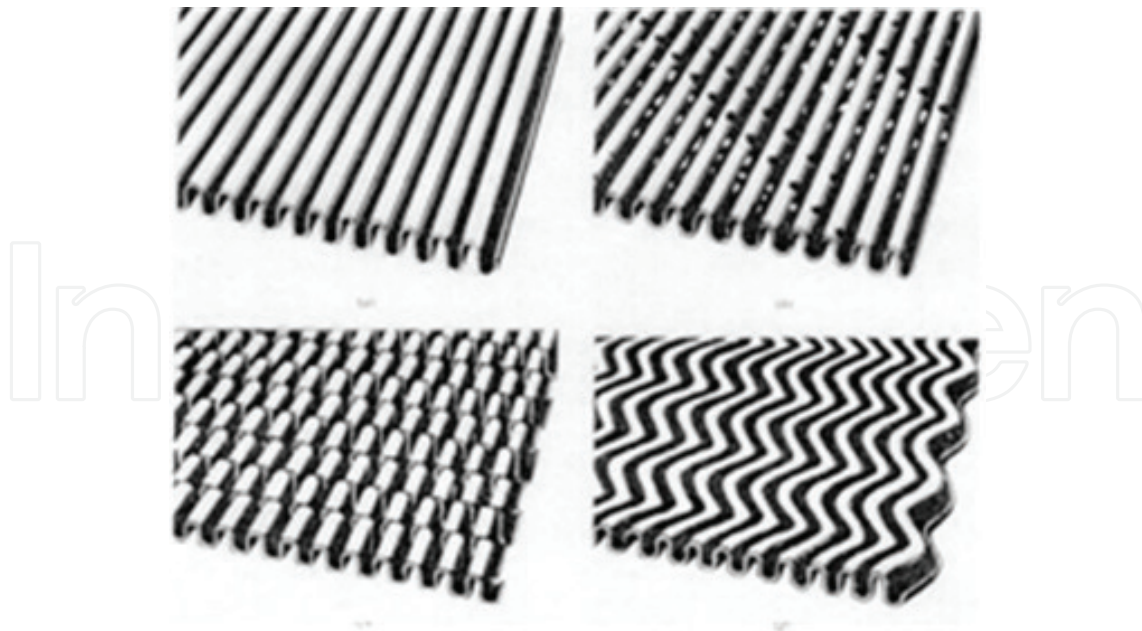

Figure 5. Some of the available secondary surfaces for plate-fin heat exchangers: (a) top left: plain-fin, (b) top right: perforated-fin, and (c) bottom left: offset-fin, (d) bottom right: wavy.

PFHE is characterized by: number of plates (N), number of passages (P), plate length (L), plate width (W), chevron angle (β), plate spacing (b), port diameter (D_p), plate thickness (τ), and enlargement factor (ϕ). The latter term refers to the ratio of the actual surface area of a plate to the area projected on the plane. **Figure 6** shows a typical exchanger assembly and the geometrical features [11].

The corrugation of the plates in a PFHE strongly determines the performance of the unit. The most common corrugation is the chevron type. This is characterized by an angle β with

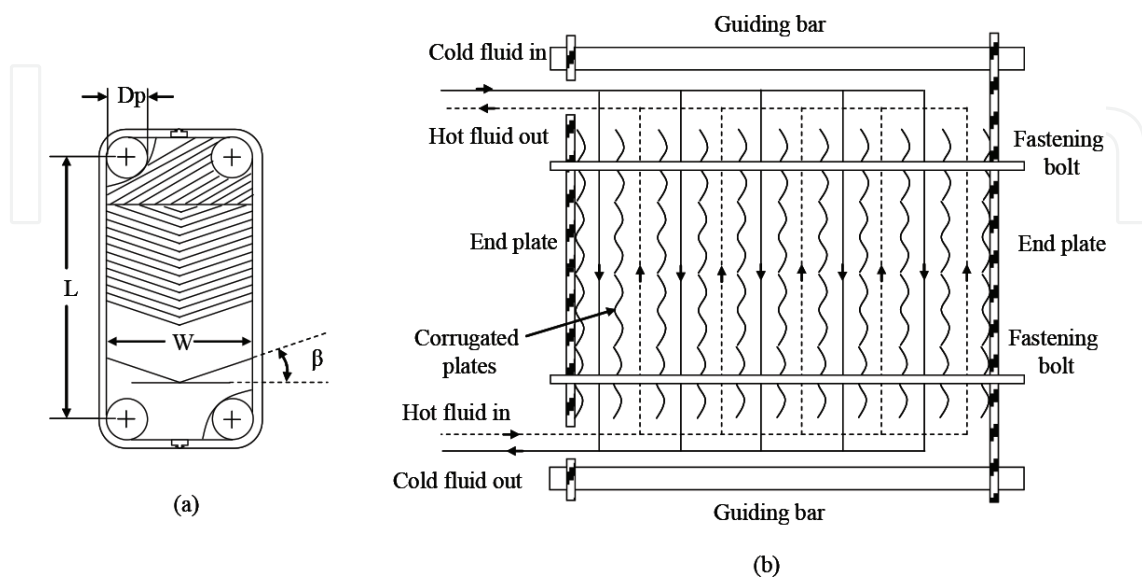

Figure 6. Plate and frame heat exchanger: (a) geometry of a chevron plate and (b) overall exchanger assembly.

respect to the horizontal perpendicular to the direction of the flow. Designs with a low β angles present high level of turbulence, high heat transfer coefficients, and pressure drop, whereas designs with high values of β exhibit low turbulence and therefore lower heat transfer coefficients and pressure drops. The chevron angle is depicted in **Figure 6(a)**.

The flexible construction of PFHE is of great value during retrofit either for increased throughput or for increased heat recovery. The structure can easily be adjusted to achieve the required heat load within the restrictions of the specified pressure drop. This can be achieved by: (a) increasing or reducing the number of thermal plates, (b) changing the type of plate, or (c) by modifying the number of passes.

There are several possible flow pass arrangement options with this type of exchangers; however, all of them stem from the combination of the three basic types (**Figure 7**): series, circuit, and complex. If the variable P represents the number of passes, the number of thermal plates N in a series arrangement is $N = 2P - 1$. A series arrangement is the choice in situations with low flow rates and with close temperature approaches. Circuit arrangements are more commonly used in applications with large flow rates and with close temperature approaches. Multiple pass arrangements result from the combination of the circuit and series arrangement; they are used when higher velocities for increased absorption of pressure drop is desirable.

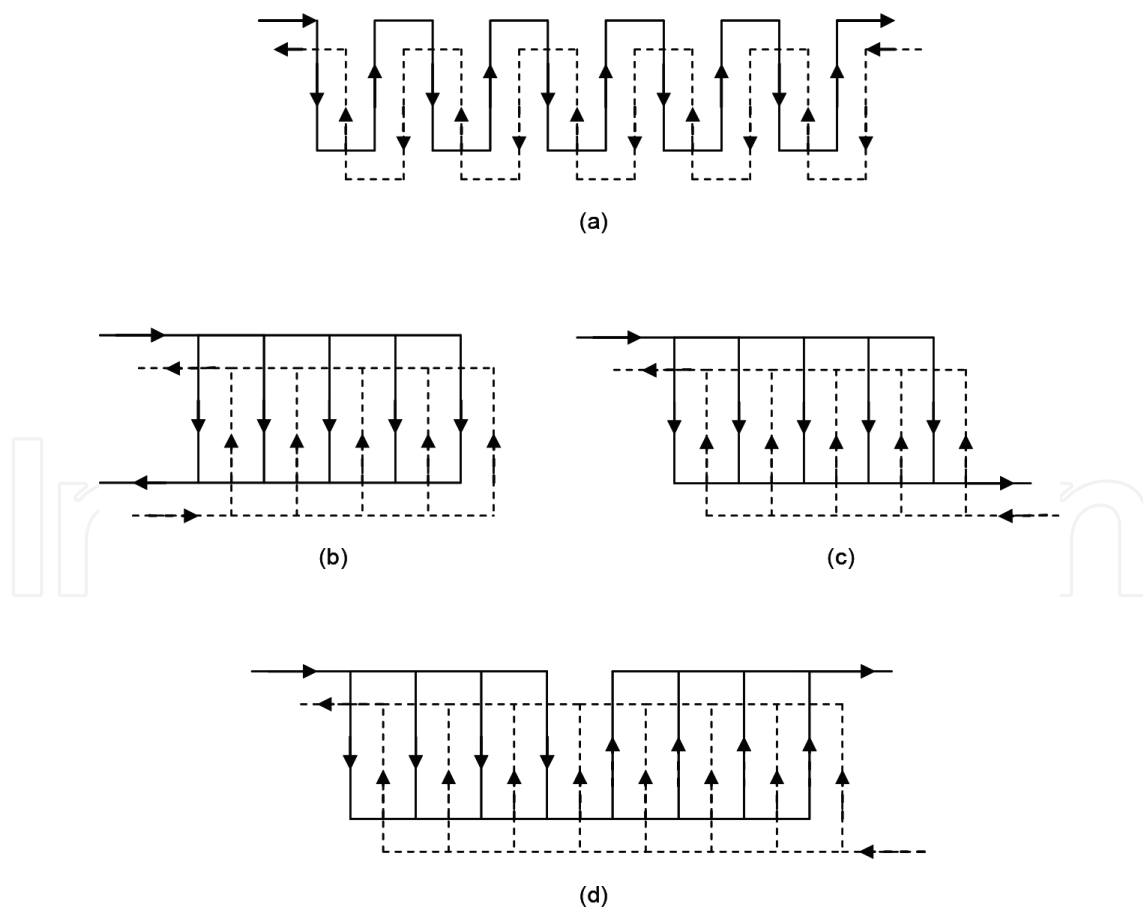

Figure 7. Flow passage arrangements in plate and frame heat exchangers: (a) series, (b) U circuit, (c) Z circuit, and (d) single pass-two pass.

Fundamental aspects in the design of a PFHE are the thermo-hydraulic performance of the plates and its size. They are a degree of freedom when sizing the unit to meet the given heat load subject to the restrictions of pressure drops of the fluids [12].

From the operating point of view, there are two main situations that reduce the thermal effectiveness of PFHE: (a) flow maldistribution and (b) the effect of end channels and channels between passes. The problem of flow maldistribution arises because of unequal pressure drop in channels [13]. On the other hand, the end plate effect is the unavoidable result of the inherent geometry of this type of technology [14].

3.3. Spiral heat exchangers

Spiral heat exchangers (SHE) are suitable for applications that involve highly viscous liquids and dirty fluids. In a spiral heat exchanger, the fluid is forced to a continual change of direction it flows through the unit as shown in **Figure 8**. This motion change creates high shear stress that eliminates stagnant zones and increases heat transfer coefficients compared to conventional flat surfaces. The continual change of direction also maintains suspended solids in motion preventing their deposition and thus reducing fouling [15].

Even though the fluids flow is overall counter-current arrangement, careful analysis of the local temperature driving forces indicates that this geometry creates disturbance on the driving forces making it depart from an ideal counter-current behavior. The operation of a SHE is associated to two thermal situations that reduce its effectiveness. One is related to what is called the end effects. For instance, all along the length of the unit, each stream exchanges heat with two adjacent streams but in the innermost and outermost part of the unit, heat is transferred only to one side of the channel as shown in **Figure 8**. The second thermal effect is related to the exchange of heat with two adjacent streams. In internal channels, the hot fluid exchanges heat across two adjacent cold channels each at different temperatures; this situation results in disturbed temperature driving forces. These effects are accounted for in design by means of correction factors. The determination of the correction factor for this geometry is

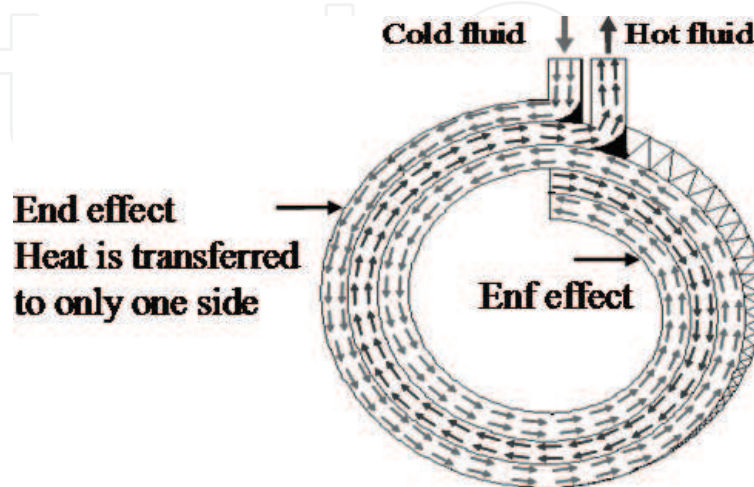

Figure 8. Relative flow of fluids within a spiral heat exchanger.

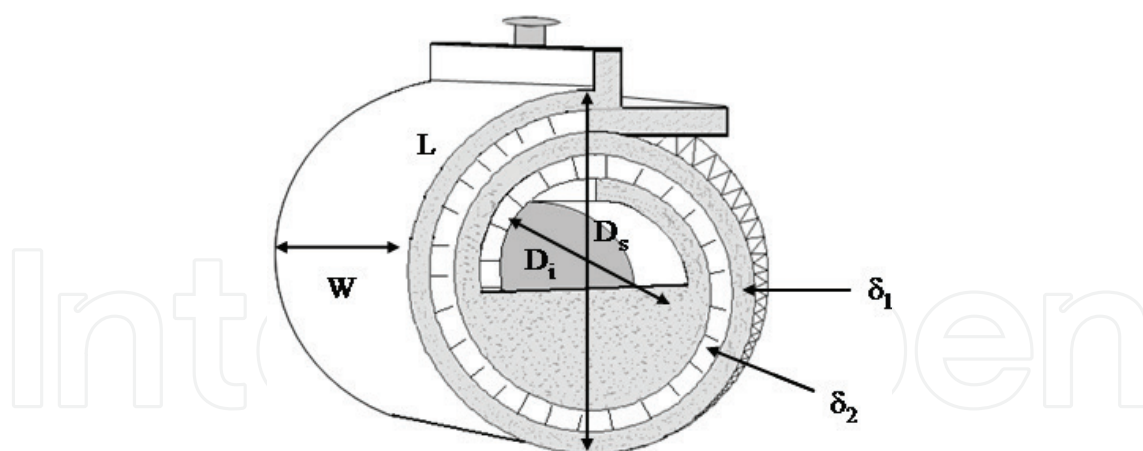

Figure 9. Geometrical features of a spiral heat exchanger.

quite elaborate; however, there are simplified expressions developed in [15] to approximate the correction factor as a function of three parameters: the number of heat transfer units, the number of turns, and the heat capacity rate ratio.

Spiral heat exchangers consist of parallel plates and the space between them is kept by means of bolts that do not have a significant effect upon the thermohydraulic performance of the unit. The geometrical definition of a spiral exchanger requires the specification of: plate spacing of the two streams (δ_1 and δ_2), plate width (W), inner diameter (D_i), outer diameter (D_s), and plate length (L) as shown in **Figure 9**.

The heat transfer performance of SHE is a strong function of the average curvature of the unit represented by the Dean number (K) [16, 17]. As the curvature of a SHE increases, the heat transfer coefficient also does. This effect is more significant in laminar flow regimes than for turbulent regimes [18].

4. Turbulence promoters for tubular geometries

Over the past three decades, a considerable amount of work has been done on the development of turbulent promoters for use in tubular heat exchangers. Since most industrial heat exchangers operate under a turbulent regime, this flow regime has been the focus of the research. The turbulence promoter most widely known and applied in industrial applications is by far the wire matrix type. One of the most successful commercial designs is called HiTRAN [19]. **Figure 10** shows the mechanical construction of this type of insert.

In operation, a wire matrix turbulence promoter makes the most of the velocity profiles of a fluid flowing inside a tube. The center of the tube, where the highest velocity occurs, hits the central part of the insert where the matrix is denser than the sections near the walls. The higher velocity fluid is redirected in the radial direction to the walls where the laminar sublayer is fully removed. The final effect is the increase of the heat transfer coefficient.

Many new types of turbulence promoters have been developed recently. Common types are: twisted tapes [20–24], winglets tapes [25, 26], circular rings [23, 27], horseshoe baffles [28],

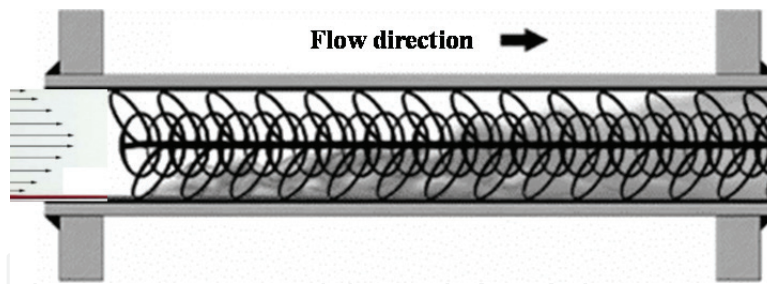

Figure 10. Mechanical features of the wire matrix turbulence promotor (HiTRAN).

helical inserts [29], and coil wires [30]. The optimization of their design for improving thermohydraulic performance has been the focus of research. For instance, in [20] modifications that included different size perforations along the tape were made. Another variation was implemented in [21] through the incorporation of pins into the twisted tapes. Other designs such as the proposed in [23] consists of inserts formed by circular-rings combined with twisted tapes. Alternatively, the twisted tapes have been modified including v-cuts along the length [22]. Other varieties of twisted tape technology have been reported in [23, 24].



The modification of basic insert geometries is done seeking to improve on its thermohydraulic performance as is the case of the delta-winglet tape where a considerable augmentation of the heat transfer and friction factor rate has been reported [25, 26]. Some other geometries exhibit improved thermal performance but at the cost of considerable increase of pressure drop. This case was reported in [27] for the v-shaped rings. Other types of geometries are: the inclined horseshoe [28] and the triple helical tape insert [29]. Most thermohydraulic performance expressions derived from experimental work have derived using water and air as thermal fluids under turbulent conditions.

Passive process intensification methods are a very effective tool to reduce the size of new heat exchangers or to enhance the capacity of existing units. The performance of turbulence promoters under turbulent regime is studied based on the coefficient of thermal improvement (η). This parameter provides a means of interpreting the improvement in heat transfer and pressure drop and serves as a performance comparison factor for design and selection purposes. A sample of the many turbulence promoter geometries encountered in the open literature is shown in **Table 1**. The selection includes those geometries that exhibit high thermal performance and low pressure drop. The heat transfer improvement of these systems goes from 30 to 500%. The recommended value of the coefficient of thermal improvement is one or above. The data reported in **Table 1** correspond to those systems with the largest η values which are recommended for industrial applications.

4.1. Performance comparison

The performance parameter used to compare the thermohydraulic performance of turbulence promoters is the thermal enhancement factor or coefficient of thermal enhancement (η). This parameter is determined assuming the same pumping power in the bare tube and the tube with inserts. This is expressed as:

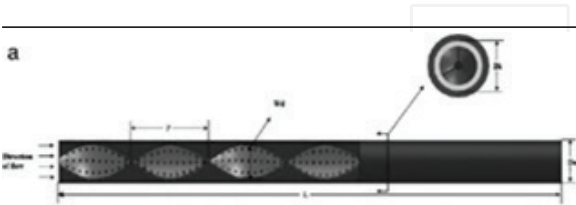
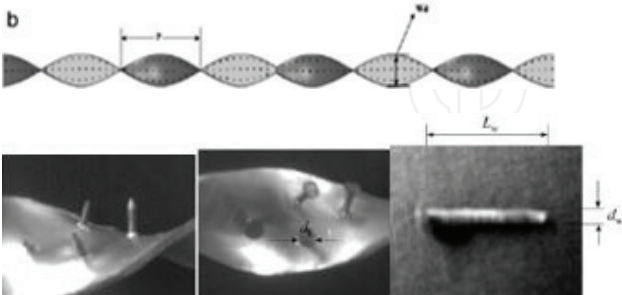
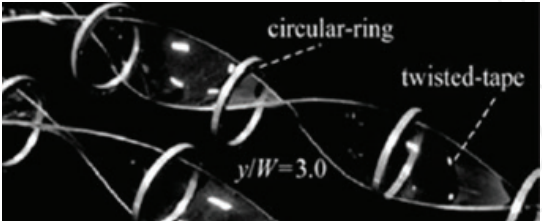
$$(\dot{V} \cdot \Delta P)_p = (\dot{V} \cdot \Delta P)_s \quad (7)$$

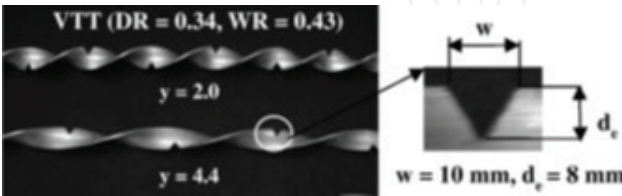
Turbulence promoter configuration	Reference	Name	Working fluid	Parameters	Reynolds range	Nup/Nus	fp/fs	TEF (η)
	[20]	Perforated twisted tape	Air, turbulent	$R_p = 1.6-14.7\%$	7200-49,800	2.07-4.4	2.1-4.6	1.28-1.59
	[21]	Twisted tape with wire-nails	Air, turbulent	$y = 2, 4.4, 6$ $L_w = 14 \text{ mm}$ $d_w = 2 \text{ mm}$ $d_h = 4 \text{ mm}$	2000-12,000	1.66-1.93	2.67-5.8	1.06-1.30
	[22]	Circular-rings and twisted tapes	Air, turbulent	$y/W = 3, 4, 5$ $l/D_i = 1, 1.5, 2$	6000-20,000	CR alone 2.36-2.80 CR and TT 2.44-4.70	CR alone 7.4-13.75 CR and TT 11.94-35.83	CR alone 1.09-1.25 CR and TT 1.04-1.42
	[29]	Triple helical tape insert	Air, turbulent	$\alpha = 9, 13, 17, 21^\circ$ rod = 12 mm	22,000-51,000	2.75-4.50	1.9-3.0	2.15-3.70
	[22]	V-cut twisted tape	Water, turbulent	$y = 2, 4.4, 6$ $d_v/W = 0.34, 0.43$ $w/W = 0.34, 0.43$	2000-20,000	1.36-2.46	2.49-5.82	1.07-1.27

Turbulence promoter configuration	Reference	Name	Working fluid	Parameters	Reynolds range	Nup/Nus	fp/fs	TEF (η)
	[24]	TT with alternate axes with different wings	Water, turbulent	$d/W = 0.1, 0.2, 0.3$ $b/W = 0.2$ $y/W = 4.0$	5500–20,200	Tra 1.74–2.85 Rec 1.68–2.64 Tri 1.62–2.49	Tra 4.35–7.99 Rec 3.83–6.72 Tri 3.54–6.26	Tra 1.06–1.42 Rec 1.05–1.39 Tri 1.04–1.35
	[25]	Staggered-winglet perforated-tapes (WPT) and staggered-winglet tape (WTT)	Air, turbulent	$B_R = 0.1, 0.15, 0.2, 0.25, 0.3$ $P_R = 0.5, 1.0, 1.5$ $\alpha = 30^\circ$ $A_{tr}/A_t = 0.125$	4180–26,000	WPT 2.39–4.78 WTT 4.63–4.90	WPT 4.87–42.69 WTT 33.46–49.80	WPT 1.23–1.71 WTT 1.26–1.52
	[27]	V-shaped rings	Air, turbulent	$RB = 0.1, 0.15, 0.2$ $Rp = 0.5, 1.0, 1.5, 2.0$ $\alpha = 30^\circ$	5000–25,000	2.47–5.77	6.57–82.01	1.15–1.63
	[28]	Inclined horseshoe baffles	Air, turbulent	$B_R = 0.1, 0.15, 0.2$ $P_R = 0.5, 1.0, 2.0$ $\alpha = 20^\circ, 45^\circ$	5300–24,000	20° 1.92–3.08 45° 2.56–3.10	20° 1.78–6.76 45° 3.16–6.84	20° 1.34–1.92 45° 1.29–1.82
								

Table 1. Thermo-hydraulic parameters of turbulence promoters reported in the literature.

The relationship between the friction factor and the Reynolds number is given by:

$$(f \cdot Re^3)_p = (f \cdot Re^3)_s \quad (8)$$

Or rearranging by:

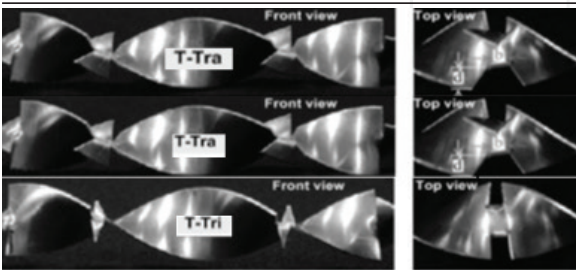
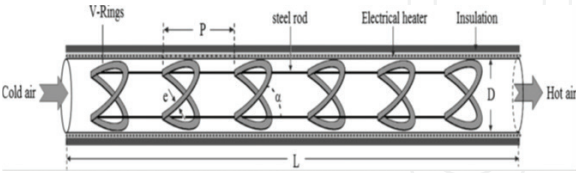
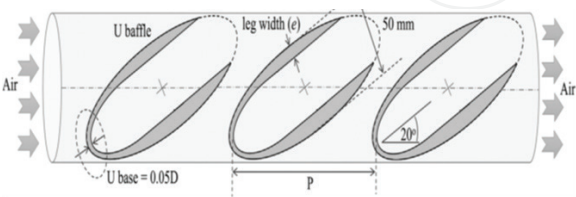
$$Re_s = Re_p \left(\frac{f_p}{f_s} \right)^{\frac{1}{3}} \quad (9)$$

The thermal improvement factor (η) is the ratio between the heat transfer coefficient, h_p , of the tube with the insert and that of the bare tube, h_s .

$$\eta = \frac{h_p}{h_s} \Big|_p = \frac{\left(\frac{Nu_p}{Nu_s} \right)}{\left(\frac{f_p}{f_s} \right)^{\frac{1}{3}}} \quad (10)$$

The value η reduces as Re increases, except for the triple helical tape insert where the factor increases with Re .

4.2. Guide to insert selection

The selection of the suitable turbulence promoter for a given application must consider the following criteria:

1. The values of η must be larger than one. Values above this figure, indicate that more heat can be recovered for the same geometry and pumping power.
2. The Reynolds number where the insert operates must be within the same range as the data is available.
3. The operating pressures must be within the limits determined by the materials of construction.

5. Conclusions

The main resistance to heat transfer in conventional heat exchangers is the thermal conduction through the laminar sublayer attached to the surface. Improvement of the heat transfer rate involves the removal of this layer at the expense of increased pressure drop. Heat transfer enhancement techniques can be applied at the design stage of new units or in the retrofit of existing units. In design, fluid velocity is a degree of freedom that can be manipulated by appropriate choice of the exchanger dimensions related to cross sectional area. Alternatively, mechanical devices such as inserts are available to promote local turbulence and increase the heat transfer rate. Such devices can also be used in retrofit for increased heat recovery or increased production. New exchanger technology has emerged to provide alternative

solutions to accomplish the following goals: (1) to achieve the given heat load within the limitations imposed by pressure drop in the smaller heat transfer equipment, or (2) increase the heat load within the limitations of pressure drop for the same installed heat transfer area.

New exchanger technology is evolving in the direction of more compact surfaces. A compact surface is designed such that the thermohydraulic performance shows higher heat transfer rate and reduced pressure drop. One of the main problems still to overcome with compact surfaces is the limitations they have in terms of the operating conditions that can withstand, since they cannot operate at high temperatures and pressures. Research and development in this area are focused in the development of new geometries and materials of construction.

Nomenclature

b	plate spacing (mm)
D_i	inner diameter (m)
D_s	outer diameter (m)
D_p	port diameter (m)
d_h	hydraulic diameter (m)
h	heat transfer coefficient ($W/m^2 \text{ } ^\circ C$)
F	ratio of new velocity to original velocity
f	friction factor (-)
f_s	ratio of secondary surface to total surface area (-)
K	parameter in correlation for heat transfer coefficient
K_p	parameter in expression for pressure drop
k	fin thermal conductivity ($W/m \text{ } ^\circ C$)
L	plate length (m)
N	number of thermal plates (-)
Nu	Nusselt number (-)
P	number of passages (-)
Re	Reynolds number (-)
\dot{V}	volumetric flow rate (m^3/s)
v	fluid velocity (m/s)
W	plate width (m)

Greek letters

β	helical baffle angle, chevron angle ($^{\circ}$)
β_s	surface area to volume between plates (m^2/m^3)
δ	plate spacing (mm)
η	thermal enhancement factor (-)
ϕ	area enlargement factor (-)
ΔP	pressure drop (Pa)
τ	fin thickness, plate thickness (mm)

Subscripts

p	bare tube
t	tube side
s	shell side, tube with inserts

Superscripts

N	new condition
0	original condition

Author details

Martín Picón-Núñez*, Jorge C. Melo-González and Jorge Luis García-Castillo

*Address all correspondence to: picon@ugto.mx

Department of Chemical Engineering, University of Guanajuato, Mexico

References

- [1] Hesselgreaves JE. Compact Heat Exchanger: Selection, Design and Operation. 1st ed. Oxford: Pergamon; 2001
- [2] Polley GT, Reyes Athie CN, Gough M. Use of heat transfer enhancement in process integration. Heat Recovery Systems and CHP. 1992;**12**(3):191-202
- [3] Sivarajan C, Rajasekaran B, Krishnamohan N. Numerical and experimental study of helix heat exchanger. International Journal of Engineering Research and Technology. 2014;**2**(4):2278-0181

- [4] Movassang SZ, Taher FN, Razmi K, Azar RT. Tube bundle replacement for segmental and helical shell and tube heat exchangers. *Applied Thermal Engineering*. 2013;**51**:1162-1169
- [5] Zhang L, Xiaa Y, Jianga B, Xiaoa X, Yang X. Pilot experimental study on shell and tube heat exchangers with small-angles helical baffles. *Chemical Engineering and Processing*. 2013;**69**:112-118
- [6] Chen GD, Zeng M, Wang QW, Qi SZ. Numerical studies on combined parallel multiple shell-pass shell-and-tube heat exchangers with continuous helical baffles. *Chemical Engineering Transactions*. 2010;**21**:229-234
- [7] Gao B, Bi Q, Nie Z, Wu J. Experimental study of effects of baffle helix angle on shell-side performance and shell-and-tube heat exchangers with discontinuous helical baffles. *Experimental Thermal and Fluid Science*. 2015;**68**:48-57
- [8] Picón-Núñez M, García-Castillo JL, Alvarado-Briones B. Thermo-hydraulic design of single and multi-pass helical baffle heat exchangers. *Applied Thermal Engineering*. 2016;**105**(25):783-791
- [9] Kays WM, London AL. *Compact Heat Exchangers*. 3rd ed. EUA: McGraw Hill; 1984
- [10] Marriott J. Recover more heat with plate heat exchangers. *Chemical Engineering*. 1971;**78**(8):127-134
- [11] Picón-Núñez M. Heating and Cooling Systems Analysis Based on Complete Process Network. In: Rahman MS, Ahmed J. *Handbook of Food Process Design*. 1st editors. Oxford, UK: Black Well Publishing Limited. March 2012. p. 299-334
- [12] Ayub ZH. Plate heat exchanger literature survey and new heat transfer and pressure drop correlations for refrigerant evaporators. *Heat Transfer Engineering*. 2003;**25**(4):3-16
- [13] Prabhakara BR, Krishna PK, Sarit KD. Effect of flow distribution to the channels on the thermal performance of a plate heat exchanger. *Chemical Engineering and Processing*. 2002;**41**:49-58
- [14] Gut JAW, Pinto JM. Modeling of plate heat exchangers with generalized configurations. *International Journal of Heat and Mass Transfer*. 2003;**46**:2571-2585
- [15] Wilhelmsson B. Consider spiral heat exchangers for fouling applications. In: *Hydrocarbon Processing*. Houston, Texas: Gulf Publishing Company; 2005. pp. 81-83
- [16] Martin H. *Heat Exchangers*. 1st ed. Hemisphere Publishing Corporation; New York, USA; 1992. pp. 73-82
- [17] Minton PE. Designing spiral heat exchangers. *Chemical Engineering*. 1970;**77**:103-112
- [18] Egner MW, Burmeister LC. Heat transfer for laminar flow in spiral ducts of rectangular cross section. *Journal of Heat Transfer*. 2005;**27**:352-356
- [19] Drögemüller P. The use of HitRAN wire matrix elements to improve the thermal efficiency of tubular heat exchangers in single and two-phase flow. *Chemie-Ingenieur-Technik*. 2015;**87**(3):188-202

- [20] Bhuiya MMK, Chowdhury MSU, Saha M. Heat transfer and friction factor characteristics in turbulent flow through a tube fitted with perforated twisted tape inserts. *International Communications in Heat and Mass Transfer*. 2013;**46**:49-57
- [21] Murugesan P, Mayilsamy K, Suresh S. Heat transfer and friction factor studies in a circular tube fitted with twisted tape consisting of wire-nails. *Chinese Journal of Chemical Engineering*. 2010;**18**:1038-1042
- [22] Murugesan P, Mayilsamy K, Suresh S, Srinivasan PSS. Heat transfer and pressure drop characteristics in a circular tube fitted with and without V-cut twisted tape insert. *International Communications in Heat and Mass Transfer*. 2011;**38**:329-334
- [23] Eiamsa-ard S, Kongkai-paiboon V, Nanan K. Thermohydraulics of turbulent flow through heat exchanger tubes fitted with circular-rings and twisted tapes. *Chinese Journal of Chemical Engineering*. 2013;**21**:585-593
- [24] Wongcharee K, Eiamsa-ard S. Heat transfer enhancement by twisted tapes with alternate-axes and triangular, rectangular and trapezoidal wings. *Chemical Engineering and Processing Process Intensification*. 2011;**50**:211-219
- [25] Skullong S, Promvong P, Thianpong C, Pimsarn M. Heat transfer and turbulent flow friction in a round tube with staggered-winglet perforated-tapes. *International Journal of Heat and Mass Transfer*. 2016;**95**:230-242
- [26] Skullong S, Promvong P, Thianpong C, Jayranaiwachira N. Thermal behaviors in a round tube equipped with quadruple perforated-delta-winglet pairs. *Applied Thermal Engineering*. 2017;**115**:229-243
- [27] Chingtuaythong W, Promvong P, Thianpong C, Pimsarn M. Heat transfer characterization in a tubular heat exchanger with V-shaped rings. *Applied Thermal Engineering*. 2017;**110**:1164-1171
- [28] Promvong P, Tamna S, Pimsarn M, Thianpong C. Thermal characterization in a circular tube fitted with inclined horseshoe baffles. *Applied Thermal Engineering*. 2015;**75**:1147-1155
- [29] Bhuiya MMK, Ahamed JU, Chowdhury SU, Kalam MA. Heat transfer enhancement and development of correlation for turbulent flow through a tube with triple helical tape inserts. *International Communications in Heat and Mass Transfer*. 2012;**39**:94-101
- [30] Gunes S, Ozceyhan V, Buyukalaca O. Heat transfer enhancement in a tube with equilateral triangle cross sectioned coiled wire inserts. *Experimental Thermal and Fluid Science*. 2010;**34**:684-691