

**PRODUCTION AND DESTRUCTION OF NITROGEN  
OXIDES IN ALTERNATING CURRENT  
PLASMA REACTORS**

By

**GURBRINDER S SIDHU**

Bachelor of Chemical Engineering

Panjab University

Chandigarh, India

1990

Submitted to the Faculty of the  
Graduate College of the  
Oklahoma State University  
in partial fulfillment of  
the requirements for  
the Degree of  
**MASTER OF SCIENCE**  
May, 1995

PRODUCTION AND DESTRUCTION OF NITROGEN  
OXIDES IN ALTERNATING CURRENT  
PLASMA REACTOR

Thesis Approved:

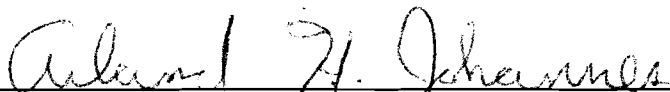

Thesis Adviser

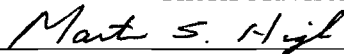



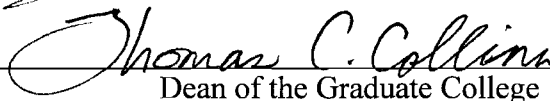

Dean of the Graduate College

## ACKNOWLEDGMENTS

First and foremost, I wish to thank my family for encouraging and supporting me for the duration of my study. I sincerely hope their sacrifices yield the rewards in the future.

I also wish to thank Dr. A. H. Johannes for his guidance and support through this research. A. J., as we all come to know him as, is a great asset to all students under his guidance. His ability to invoke an independent thinking for research has certainly added to my abilities as an engineer. The open approach adopted by him is a gift for all his students.

To Dr. J. N. Veenstra and the members of the Faculty in the Department of Chemical Engineering I also thank you. The knowledge gained from their instruction and experience has enriched my education.

To Charles Baker a special gratitude is acknowledged. His cheerful caring and helpful attitude towards students is much appreciated.

## TABLE OF CONTENTS

Chapter	Page
I. INTRODUCTION.....	1
II. LITERATURE REVIEW.....	4
Background Information.....	4
Gas Discharge.....	5
Breakdown Voltage.....	6
Discharge Circuit.....	8
Nitrogen Oxide Chemistry.....	10
III. EXPERIMENTAL APPARATUS AND PROCEDURE .....	12
Alternating Current Plasma Reactor.....	12
Electrical Circuit.....	14
Fluid Flow.....	15
Nitrogen Oxide analyzer.....	16
Experimental Procedure.....	16
Fluid Flow.....	17
Electrical Circuit.....	19

IV. REACTOR EVALUATION AND RESULTS.....	23
Effect of frequency on power and secondary voltage.....	23
Effect of primary and frequency on power and secondary voltage...	26
Production of Nitrogen Oxides.....	30
Effect of primary voltage on production of Nitrogen Oxide.....	33
Effect of residence time on NO <sub>x</sub> production.....	33
Effect of humidity on NO <sub>x</sub> production .....	37
Effect of alternating current on Nitrogen Oxide production.....	40
V. CONCLUSIONS AND RECOMMENDATIONS.....	42
Conclusions.....	42
Recommendations.....	43
Observations.....	44
BIBLIOGRAPHY.....	45
APPENDICES	
APPENDIX A Reynolds number calculations.....	47
APPENDIX B Breakdown voltage calculations.....	48
APPENDIX C Experimental Data Tables.....	49
VITA	

## LIST OF TABLES

Table	Page
I. Reactor Specifications . . . . .	21
II. List of Experimental Equipment . . . . .	22
C-1. Experimental Data Corresponding to Figure 4.1 & 4.2 . . . . .	49
C-2. Experimental Data Corresponding to Figure 4.3 . . . . .	50
C-3. Experimental Data Corresponding to Figure 4.4 . . . . .	52
C-4. Experimental Data Corresponding to Figure 4.5 . . . . .	54
C-5. Experimental Data Corresponding to Figure 4.6 . . . . .	56
C-6. Experimental Data Corresponding to Figure 4.7 . . . . .	57
C-7. Experimental Data Corresponding to Figure 4.8 & 4.9 . . . . .	60
C-8. Experimental Data Corresponding to Figure 4.10 . . . . .	62
C-9. Experimental Data Corresponding to Figure 4.11 . . . . .	63

## LIST OF FIGURES

Figure	Page
2.1 Simplified Electrical Circuit . . . . .	8
3.1 Schematic of Alternating Current Plasma Reactor . . . . .	13
3.2 Schematic of Experimental Apparatus . . . . .	17
4.1 Effect of Frequency on Power in an Open Circuit Test . . . . .	24
4.2 Effect of Frequency on Secondary Voltage in an Open Circuit Test . . . . .	25
4.3 Effect of Primary Voltage on Power . . . . .	27
4.4 Effect of Primary Voltage on Secondary Voltage . . . . .	28
4.5 Effect of Frequency on Concentration, Secondary Voltage and Power at a Flow Rate of 100cc/min . . . . .	31
4.6 Effect of Frequency on Concentration, Secondary Voltage and Power at a Flow Rate of 250cc/min . . . . .	32
4.7 Effect of Primary Voltage on Production of Nitrogen Oxides . . . . .	34
4.8 Effect of Residence Time on Production of Nitrogen Oxides . . . . .	35
4.9 Effect of Residence Time on Production of Nitrogen Oxides . . . . .	36
4.10 Effect of Humidity on Production of Nitrogen Oxides at Low Residence Time . . . . .	38
4.11 Effect of Humidity on Production of Nitrogen Oxides at High Residence Time . . . . .	39
4.12 Effect of Alternating Current on Production of Nitrogen Oxides . . . . .	41

## NOMENCLATURE

NO <sub>x</sub>	Oxides of Nitrogen
ACPR	Alternating Current Plasma Reactors
V <sub>b</sub>	Break Down Voltage
δ	Relative Density
Ω	Ohms
F	Farads
H	Henrys
Hz	Hertz
<i>rms</i>	Root Mean Square
V	Voltage
W	Watts
A	Amperes



## **CHAPTER I**

### **INTRODUCTION**

Exploration of space began when man set the first few steps on the surface of the moon a few decades ago. But the size of space has been an enigma to mankind. To understand this unexplored territory short term missions are inadequate. The next step in space travel is to have missions for extended periods of time for deep space exploration. The primary concern of any such mission will be its ability to support human life for extended periods of time in terms of providing the basic needs like food, water and a breathable atmosphere.

Basic supplies taken for granted on earth cannot be easily provided on a space mission because of their bulky nature and the limited space available on a spaceship. The cost of transporting water to sustain one human being could make an entire mission for just one year an uneconomical task. The solution to this is to come up with a recycling support system. This system should have the ability to reproduce atmospheric conditions in a safe and predictable manner and should be easy enough to be controlled and managed by the crew. It must also have the highest degree of self sufficiency and reliability (1).

“The John F. Kennedy space center is demonstrating the feasibility of utilizing a higher plant based paradigm for advanced life support system in the Controlled

Ecological Life Support System (CELLS)" (2). Plants provide a natural food source for mankind and they compliment the existence of man by using the by products of human activity as their major resource for synthesis of food. Plants and human beings form a symbiotic balance on earth. Nitrogen is an important element for synthesis of food in plants. On earth its deficiency is normalized by the use of fertilizers or by the presence of nitrogen fixating bacteria in the soil. But since soil is another substance that cannot be carried in large quantities in a space ship it becomes important to develop techniques to provide these nutrients to the plants in an efficient manner. Hydroponics provides the solution as to finding a medium for plant growth. However we still need to fertilize this medium. To provide for the nitrates shortage in space it is imperative to develop a technology which is efficient and reliable.

Preliminary studies in Alternating Current Plasma Reactors (ACPR) have shown that an ACPR could be a feasible tool for production of nitrogen oxides. Robinowitz (3) has shown in his work at Oklahoma State University that an ACPR can be used to produce various oxides of nitrogen.

An overall objective of this research is to continue with this technique and expand on the earlier results obtained during the preliminary study, and to develop a better understanding of the parameters that influence the formation of nitrogen oxides in an ACPR. ACPR's have also proven to be an interesting tool for destruction of contaminants in air. Although detoxification of air has been the predominant reason for research on plasma reactors at OSU, production of nitrogen oxides and sulfur have also given successful results.

An ACPR uses electrical current to generate a high potential difference between two surfaces of concentric tubes. This high voltage drop causes an electrical breakdown of the gas entrapped in the annulus. The electrical breakdown of the gas is called a discharge. This discharge is initiated due to the presence of free electrons in the gas. These electrons are drawn to the positively charged surface at high speed. In the process they collide with the gas molecules which are moving at random in the annular space of the reactor. These random collisions form radicals ions and more electrons which recombine to form different kinds of neutral species. During the reaction as the electrons change energy levels there is a release of energy which can be observed as a glow with a distinct color. Thus the use of plasma reactors to obtain specific by products is an easy and efficient technique. Extensive research needs to be undertaken to understand the variables which influence the formation of these reaction products in the ACPR's. Variables like frequency, voltage, power, nature of the reactor material, type of electrodes and type of gas are important parameters which influence the behavior of these reactors. The specific objectives of this research are;

1. To reproduce the results of the preliminary research done on the production of nitrogen oxides (NO<sub>x</sub>).
2. To study the effect of residence time on production of nitrogen oxides.
3. To study the effect of humidity on NO<sub>x</sub> production.
4. To understand the relationship between secondary voltage and power input to the reactor and their effect on NO<sub>x</sub> production.
5. To understand the electrical characteristics of the ACPR.

## CHAPTER II

### LITERATURE REVIEW

Corona chemistry has been studied for almost a century now, but it has not been extensively applied for chemical synthesis because, the corona itself is a complex phenomena to control. To manipulate it to synthesize particular compounds and to control the reactions that occur in this phenomena is a difficult task. The interest in coronas as a reaction medium has grown recently because of its ability to form radicals and the availability of electricity in abundance. Corona can be defined as a purple haze that can be observed on incomplete breakdown of gas when a high voltage potential is applied across a medium containing the gas. The alternative term for this is a plasma. Researches in the past have formed coronas using different techniques and have identified the variables that influence the plasmas. Robinowitz's (3) work at Oklahoma State University has pinpointed the variables that influence the formation of nitrogen oxides. Nitrogen oxides are a major pollutants today and they directly contribute towards the deterioration of air quality and formation of acid rain. But they are also a major feed stock in the production of nitrogenous fertilizers.

NASA's mission on Mars is a long range deep space mission that requires extended stay in a stable environment for the scientist. The CELLS technology is trying

to come up with a system that controls the variables in a stable environment. CELLS aims to develop a system that maintains a balance between plants and animals in a closed loop environment. "Research during the last decade has shown that all human life support needs can be met by a bioregenerative life support system based on higher plants, algae or a combination of both" (2). CELLS has perceived a tightly controlled environment which ensures maximum crop production and output (3). In this engineered environment plants consume human waste to grow and humans consume the plant output, forming a symbiotic relationship. In a bioregenerative system like this there are very little waste products. The waste of one group is consumed by the other as food, thus forming a closed loop cycle. But plant life cannot be sustained without fertilizers and to account for the nitrate deficiency plants require constant dosage of nitrogenous fertilizers.

### Gas Discharge

Gases in general are very poor conductors of electricity due to the lack of free electrons. Dry air acts as an insulator. Any gas can become a conductor if by some mechanism we can generate free electrons in it. This phenomena of converting the gas to a conductor from an insulator is called a breakdown. The point when a gas changes from an insulator to a conductor is called a discharge. Lightning is a natural discharge phenomena. Discharges can also be initiated by the application of a high potential drop across two surfaces. On application of a high energy electric field some free electrons that are present due to cosmic rays or background radiation are accelerated in the field and these electrons speeding to the positive electrode collide with the molecules. Some

of these collisions are elastic and others are not, but eventually some of these electrons acquire high kinetic energy. When those electrons strike a molecule they knock out other electrons in the outermost orbital and generate ions, radicals and more free electrons. This creates an avalanche of free electrons and is referred to as a breakdown or discharge. Breakdown of a gas is accompanied by emission of light and sound. The radicals and ions formed on manifestation of discharge then recombine to form molecules of different or similar characteristics (4).

### Breakdown Voltage

Electrical energy is convenient to initiate breakdown of gases as its available in abundance and at a very low cost. The property of a gas that controls the amount of energy to be applied for breakdown of a gas is called the dielectric strength. The amount of electrical energy required to initiate an electrical breakdown is referred to as the breakdown voltage. Early studies conducted on reactor geometry have proved that an electrical field in concentric cylinders initiates a breakdown at lower voltages than flat plates (4). Studies conducted on reactor material have indicated that reactors made of quartz initiate a breakdown at lower voltages as compared to those made of glass (6). The annular gap in concentric cylinders also influences the breakdown voltage. Coffman et al. give the following equation for calculating the breakdown voltage (4).

$$V_b = \left[ \frac{ED_2K_g}{2} \right] \left\{ \left[ \frac{\ln(D_2 / D_1)}{K_1} \right] + \left[ \frac{\ln(D_3 / D_2)}{K_g} \right] + \left[ \frac{\ln(D_4 / D_3)}{K_2} \right] \right\} \quad (2.1)$$

$V_b$  = Breakdown voltage ( volts )

$E$  = Breakdown strength of the gas (volts/cm)

$K_g$  = Dielectric constant of the glass (volts/cm)

$D_1$  = Inner diameter of the inner tube (cm)

$D_2$  = Outer diameter of the inner tube (cm)

$D_3$  = Inner diameter of the outer tube (cm)

$D_4$  = Outer diameter of the outer tube (cm)

$K_1$  &  $K_2$  = Dielectric constant of the barrier (volts/cm)

The annular gap of the concentric cylinders influences the breakdown voltage of the gas because the amount of gas influences the dielectric of the annular space. As we increase the annular space in the cylinders the breakdown voltage increases tremendously.

Tsai (5) proposed a model for prediction of the breakdown voltages. Manning (6) has modified the model proposed by Tsai and gives an equation that accounts for the length of the plasma zone. The modified breakdown equation is:

$$V_b = \left( \frac{10.96D_2\delta}{0.709 + 0.046\sqrt{x}} \right) \left( 1 + \frac{0.308}{\sqrt{\delta D_2}} \right) \left[ \frac{\ln(D_2 / D_1)}{K_a} + \frac{\ln(D_3 / D_2)}{K_a} + \frac{\ln(D_4 / D_3)}{K_a} \right] \quad (2.2)$$

In the above equation the new variables that have been introduced are

$\delta$  = Relative density of air for any temperature and pressure

$$\delta = \frac{3.921PZ}{273 + T}$$

$P$  = pressure (cm Hg)

$Z$  = compressibility factor

$T$  = temperature ( $^{\circ}$ C)

$x$  = length of the plasma zone (cm)

$K_d$  = dielectric constant of the reactor walls (volts/cm)

$K_g$  = dielectric constant of the gas (volts/cm)

all other variables are same as equation 2.1

### Discharge Circuit

The ACPR connected to a transformer and the power source can be viewed as a simplified R-L-C circuit where C, L and R are the capacitance, inductance, and the resistance of the entire circuit as shown in the schematic below.

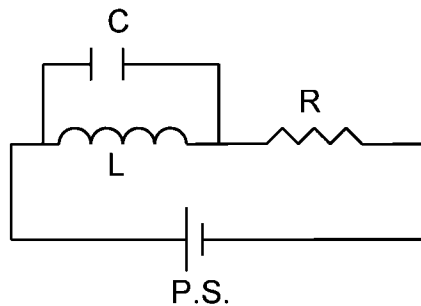

Figure 2.1 Simplified Electrical Circuit

The power equation of an electrical circuit is

$$W = I^2 R \quad (2.3)$$

The above equation gives the apparent power input into the circuit. But the reactive inductance and the reactive capacitance act in conjunction to each other and effect the true power in the circuit. The true power is given by the equation

$$W = I^2 Z \quad (2.4)$$

where the Z is the impedance of the circuit. (ohms)



$$Z = \sqrt{R^2 + (X_L^2 - X_C^2)} \quad (2.5)$$

$X_L = 2\pi fL$  is the inductive reactance of the transformer ( $\Omega$ )

$$X_C = \frac{1}{2\pi fC} \text{ is the capacitive reactance of the ACPR } (\Omega)$$

$C$  = the capacitance of the reactor (F)

$L$  = the inductance of the transformer (H)

$f$  = frequency of the alternating current (Hz)

An alternate equation for power in terms of the voltage can be written as

$$W = VI \quad (2.6)$$

$$V = IR \quad (2.7)$$

$$I = \frac{V}{R} \quad (2.8)$$

$V$  = the voltage in the circuit (V)

$I$  = the current in the circuit (A)

Earlier studies done on plasmas at OSU have shown that the ACPR's need to be tuned to attain a steady plasma and cause a break down of the gas. Theoretically the concept of tuning is embedded in equations 2.4,2.5 and 2.8. The transformer and the reactor are connected in parallel, therefore the reactive inductance and capacitance oppose each other. The value of frequency that gives us the tune point is the frequency at which the difference of reactive inductance and capacitance is at a minimum. At this point voltage and current to the reactor are maximum and the power to reactor is at its peak value. Hence the breakdown of the gas is influenced by the characteristics of the transformer and the capacitor along with nature of the dielectric of the gas and the reactor material.

Earlier studies done on ACPR at Oklahoma State University have shown that for a constant primary voltage as the frequency of the alternating current is increased the secondary voltage and the power also increase. The secondary voltage and power reach a peak value at the same frequency which can be referred to as the tune point. Increasing the frequency beyond the tune point decreases the secondary voltage and the power drawn. Tune point is the frequency at which the breakdown of the gas is initiated.

### Nitrogen Oxide Chemistry

Oxides of nitrogen, commonly referred to as NO<sub>x</sub>, exhibit a peculiar behavior due to the electronic configuration of the nitrogen atom. Nitrogen has the ability to form single, double and triple covalent bonds and this behavior of the atom gives it the ability to form different oxides. As it is the primary objective of this research to maximize the production of NO<sub>x</sub>, it is important to understand the basic nitrogen oxide chemistry and the reaction mechanisms. The primary reactions in the plasma are hypothesized to be as follows (7)

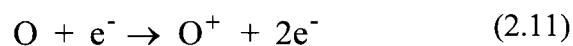
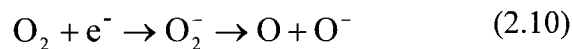
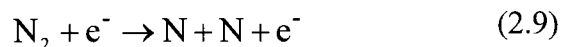

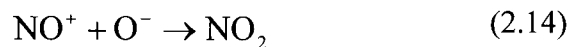

The above reaction mechanisms are suggested to occur in plasmas where the driving force for the reactions is the electronic collision of the molecules and electrons in the electric field. These molecular collisions result in formation of free radicals and ions which creates an avalanche of charged particles. Since the initial concentration of the electrons is low the initial collisions result in excitation of the molecules and are responsible for emission of light and formation of metastable molecules. These excited and metastable species are ionized to form other ions and radicals. The radicals, ions and electrons then recombine to form reaction products and neutral species. Although these equations are balanced they are by no means the only reactions that occur in the plasma reactor. These are only a few of the reactions that are most likely to result in the desired reaction products.

## **CHAPTER III**

### **EXPERIMENTAL APPARATUS & PROCEDURE**

The following chapter describes the experimental apparatus, instrumentation, the flow diagram and the procedure followed for data acquisition.

#### **Alternating Current Plasma Reactor**

An ACPR is the primary tool for this research and it consists of two concentric quartz tubes which have been fused at both ends. This gives an annular space for the flow of gas through it. The inlet and the outlet ports are located on opposite side of the outer tube. This ensures proper intermixing of the gas as it flows across the reactor and avoids the occurrence of dead zones in the flow pattern. The Reynolds number is calculated for two flow rates to determine the flow conditions (Appendix A). It is found that for residence time close to 1 second the flow regime is laminar.

The reactor was fabricated from quartz because quartz gives a more uniform plasma than pyrex or regular glass (8). The walls of the reactor act as a capacitive resistance to the flow of electric current and earlier experimental work done on materials of construction has shown that reactors made of quartz give better plasma characteristics

than other materials of construction. Quartz ensures a uniform dielectric effect throughout the reactor walls. Figure 3.1 shows the reactor geometry. This particular geometry is chosen because concentric cylindrical electrodes cause gas breakdown at lower voltages than flat plates or other configurations (4). The outer and the inner electrodes consist of 40 mesh copper sheets. The outer electrode is wrapped around the outer tube

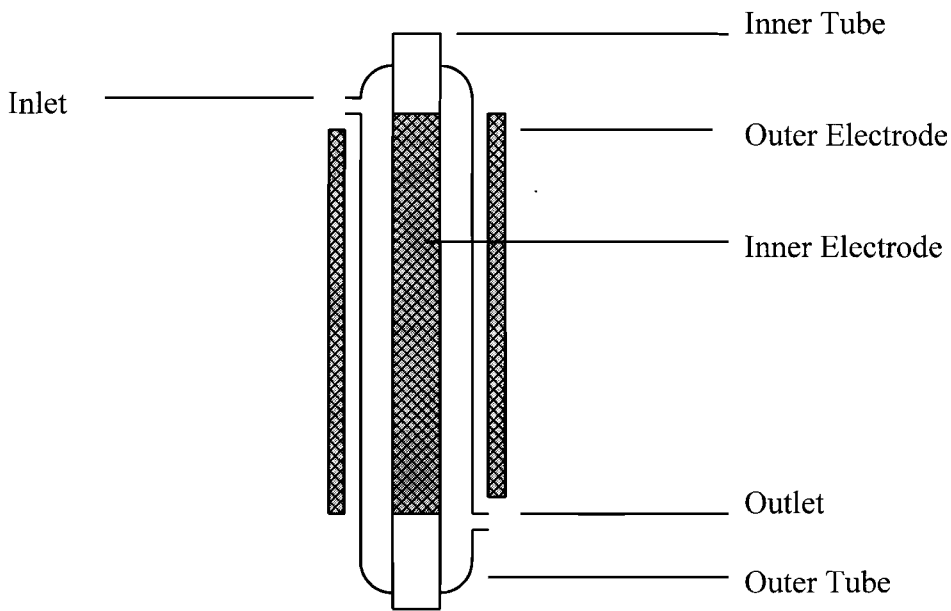

ACPR with Copper Mesh Electrodes

Figure 3.1 Schematic of an ACPR

and for the inner electrode the mesh is rolled into cylindrical form and inserted inside the inner tube. Copper mesh is preferred over wire wrapped electrodes because it gives a more uniform distribution of the plasma in the annulus and an even distribution of the potential applied across the reactor. The size of the annulus is an important factor in the reactor geometry. The width of the annular gap determines the magnitude of the voltage

to be applied across the reactor to initiate a breakdown of the gas. The annular size was chosen before fabricating the reactor using the breakdown voltage equation (eqn. 2.2). Since the maximum rating of the secondary voltage of the transformer is 15,000 V the annular gap of the ACPR is calculated by trial and error from the breakdown voltage equation and set at 0.5 cm. The calculations for the breakdown voltage are shown in appendix B.

### Electrical Circuit

The electrical circuit consists of the transformer, function generator, power source high voltage probes and fluke meters connected to measure the voltage, current and the power. The electrical circuit can be viewed as a varying impedance circuit. The entire circuit can be simplified to an inductance capacitance and a reactance. This is called a R-L-C circuit.

Power to the reactor is supplied through a California Instrument (INVERTRON) power supply which is coupled with a function generator (BK PRECISION) that has the capacity of generating an alternating current with frequencies of 2MHz. The built in oscillator did not regulate the frequency and had range limitations so an external function generator was used. The function generator has a higher range and sensitivity and the ability to generate different kinds of alternating current waves and is connected externally to the power source. The primary use of the function generator is to change the frequency in small increments to fine tune the reactor close to the breakdown voltage. Since the secondary voltage is dependent on the primary voltage, the primary voltage is measured

using a fluke multimeter. The magnitude of the primary is varied by changing the amplitude of the input AC. The secondary voltage is varied by changing the frequency of the current into the primary of the transformer.

The transformer is a Jefferson luminous transformer and is mid point grounded. This implies that the secondary voltage is twice the measured voltage on the flukemeter connected to one end of the secondary coil. The secondary voltage is measured using a high voltage probe by (Fluke) which is connected to another Fluke multimeter. The voltage probe has the ability to step down the voltage 1000 : 1 via a shunt. All the voltages that are read are the true *rms* values and not peak to peak voltages.

## Fluid Flow

Compressed dry breathing air is used as the reactant through the ACPR. The flow of air is regulated using a mass flow meter/controller (LINDE FM 4575). This flow meter regulates upto four different flow lines and has the ability to blend gas streams. The flow meter works in conjunction with Linde mass flow controllers (model 10C 202 4124) with a range of 0 to 1000 cc/min. To monitor the humidity of the gas a hygrometer/thermometer (Davis DTH1) was connected in line. The gas is passed through a bed of dryrite (  $\text{CaSO}_4$  ) to remove traces of water vapor. To increase the humidity of the gas it is bubbled through a set of Erlenmeyer flasks. The flow lines are stainless steel 1/4" T304 pipes. For flexibility and safety, 1/4" tygon tubing is connected to the ACPR.

The gas flows due to the pressure maintained by the flow controller. To maintain enough pressure for venting the gas after it has gone through the analyzer a small vacuum pump is connected downstream of the analyzer at the sample bypass port.

### NOx Analyzer

The NOx analyzer is an essential part of the experimental procedure. This particular analyzer is a chemiluminiscent type NOx analyzer which is based on the chemiluminiscent reaction



where  $h\nu$  is the amount of light emitted from the above reaction. The amount of light emitted is converted into current by a photomultiplier tube and the current is read on the output scale as a direct read of concentration of NOx in PPM.

### Experimental Procedure

The following section describes the methods incorporated for data acquisition. Figure 3.2 shows a schematic of the flow diagram. The variables that need to be monitored for this particular research are:



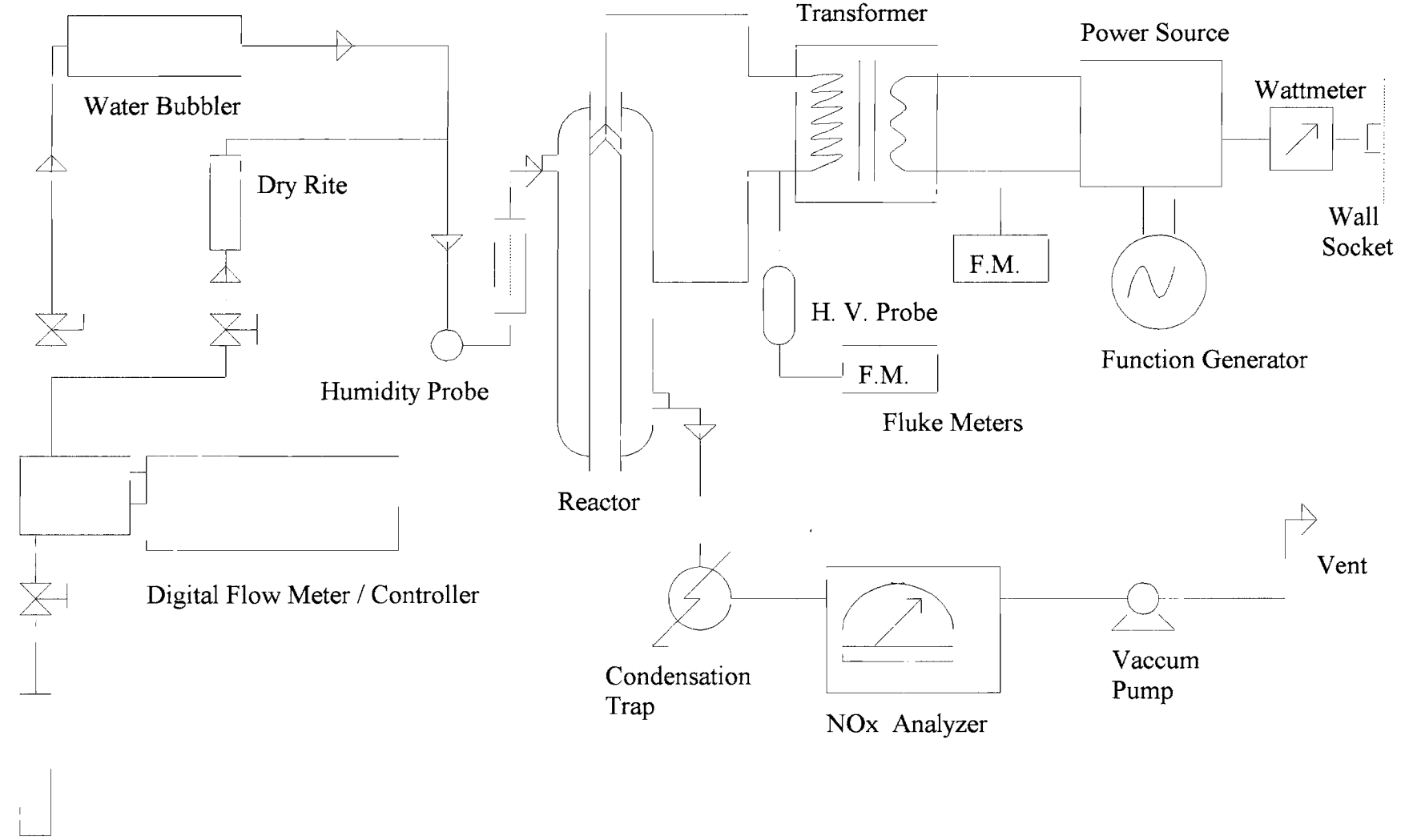

Compressed Breathing Air

**Figure 3.2**  
Schematic of The Experimental Apparatus

- ◆ Primary Voltage
- ◆ Residence time
- ◆ Humidity
- ◆ Power input

### Fluid Flow

To start an experimental run, the initial step is to establish a steady flow rate of the gases and to check the flow lines for leakage. The flow rate was set at 100 cc/min with the digital flow meter and the line pressure to the controller was set at 20 psig as per the controller specification. The power to the NO<sub>x</sub> analyzer and the external bypass pump was then switched on. The pressure on the sample bypass gage must show a reading of at least 5 in. Hg. The flow was verified by checking the rotameter on the instrument. The sample input mode switch was set to NO<sub>x</sub> and the NO<sub>x</sub> converter temperature was set at 650 °C. The converter needs around 20 mins. to warm up and then the voltage to the photomultiplier tube is turned on. The recorder output is checked by setting the range selector switch to zero and full scale. Adjustments to decrease the background concentration are done by suppressing background current with the background suppression potentiometer. The power to the ozone generator was then turned on. All the above steps are necessary to calibrate the analyzer and were repeated each time an experimental run was conducted.

## Electrical Circuit

Once a steady flow has been established, the function generator is turned on and the power to the power source is turned on. The power to the Fluke meters is also turned on. To conduct the initial runs, the frequency on the function generator is set at 60 Hz as this is the rating of the transformer. The primary voltage is set at 40 V. The power drawn from the wall outlet is noted, and the secondary voltage is read from the fluke meter. The value of the secondary voltage and the power is high at 60 Hz because the rating of the transformer is set at this particular value for commercial applications. Next the frequency of the current to the primary is varied in increments of 10 Hz. In the next step the current to primary is varied from 50 to 90 V in increments of 10 V and the frequency is varied in increments of 10 Hz from 60 Hz to 650 Hz at each of these primary voltages. The values of secondary voltage, power and NO<sub>x</sub> concentration are read and noted for each increment of the frequency. The above procedure gives the optimum amount of NO<sub>x</sub> produced at the set value of the primary voltage, and the effect that varying frequency has on the production.

To account for the residence time, the flow rate of the gas is increased and the steps for fluid flow and the electrical circuit as described above are followed.

The effect of relative humidity was studied by bubbling the gas through a series of Erlenmeyer flasks. Presence of water in the gas leads to formation of nitric acid and this increases the amount of background concentration at calibration, to overcome the effect of background effect the effluent lines are changed after every humidity run.

---

Reactor specifications and the list of experimental equipment are given on the following pages in Tables 3.1 and 3.2 respectively.

Table 3.1

---

**Reactor Specifications**

---

Material of Construction	Quartz
I.D. of the outer tube	3.2 cm
O.D. of inner tube	2.2 cm
Width of annular gap	0.5 cm
Length of the reaction zone	30.5 cm
Annular Volume	47.87 cm <sup>3</sup>
Electrode Material	Copper mesh
Mesh size	40

---

Table 3.2

---

**List of Experimental Equipment**

---

Instrument	Supplier & Specification
A.C. Power Source	California Instruments, Model 1001TC
Function Generator	B.K. PRECISION, Model 3011B
Flow Meter	Linde, Model FM 4575
Flow Controller	Linde, Model 10C 202 4124
Watt Meter	General Electric, Model No. 3720341 Type P-3, Single Phase
Multimeters	John Fluke Mfg. Co. Model 8050 A
High Voltage Probe	John Fluke Model 80K40
High Voltage wiring	Taylor Pro-Wire, 8mm Silicone core
Transformer (A and B )	Jefferson (luminous tube transformer) Primary 120V, 60Hz, Secondary 15000V Mid point grounded
Hygrometer	Davis Instrumentation, Model DTH1

---

## CHAPTER IV

### REACTOR EVALUATION & RESULTS

Preliminary work done on NO<sub>x</sub> production by Robinowitz (3) indicated that the ACPR can be used as a device for production and destruction of NO<sub>x</sub>. But the response of the reactor to the electrical characteristics, fluid flow and the composition of the gas with respect to humidity are not completely understood. In the following chapter the effects of the various parameters is discussed along with the experimental results.

#### Effect of frequency on power and secondary voltage

Figures 4.1 and 4.2 show power and secondary voltage input to the circuit in an open circuit test for two identical transformer. An open circuit in this case would imply no load on the transformer (i.e. the reactor is not connected in the circuit). It can be seen that the power increases linearly as the frequency is increased at a set primary voltage. And after it has reached a maximum, the power begins to level off into a straight line with a slope of zero. Once the maximum has been reached the power drawn remains constant. There is no increase in the power with an increase in the frequency. This is a characteristic curve for power, and is dependent on the type of the transformer used. Each transformer has a slightly different characteristic curve. Although different

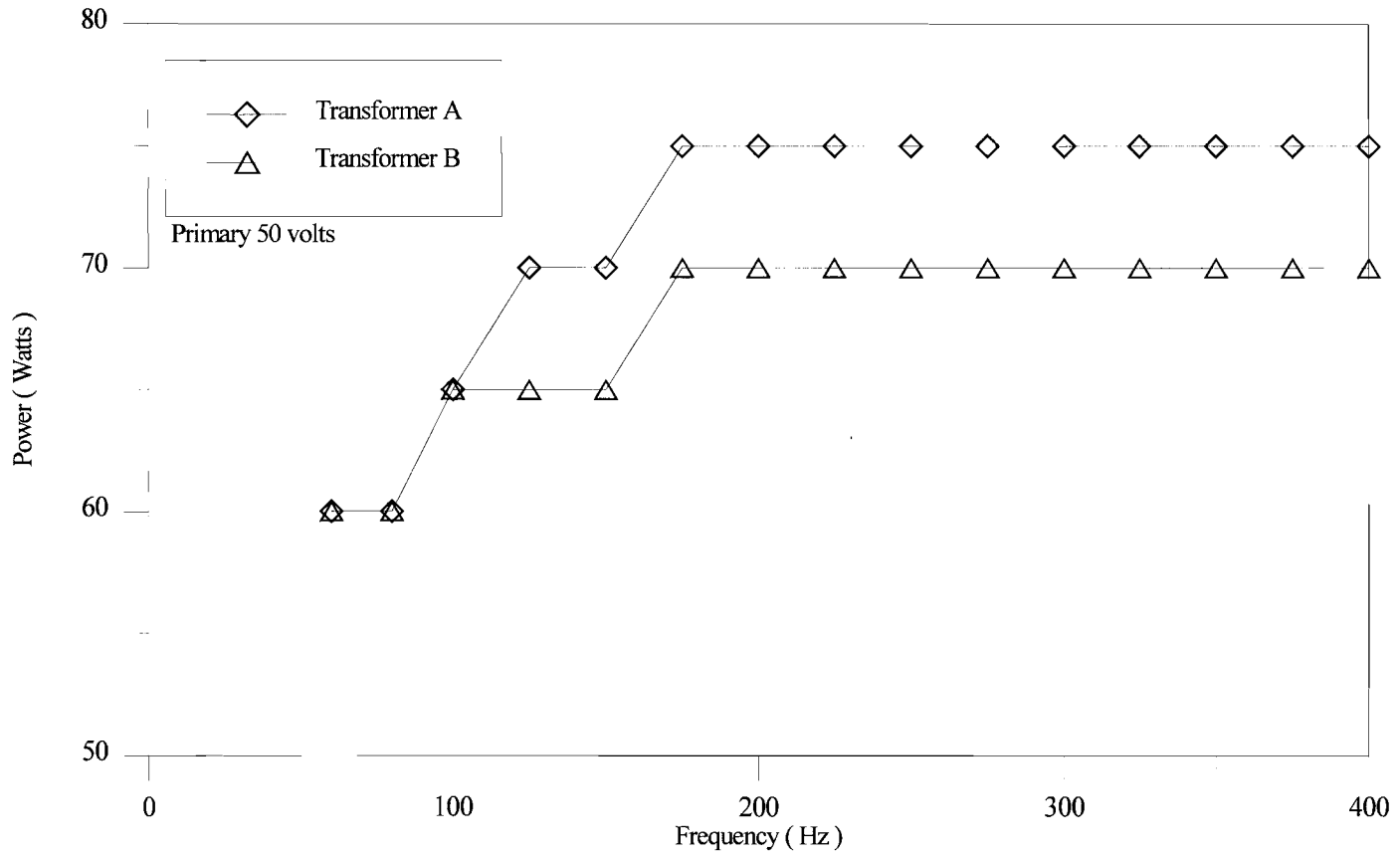

Figure 4.1 Effect of Frequency on Power in an Open Circuit Test



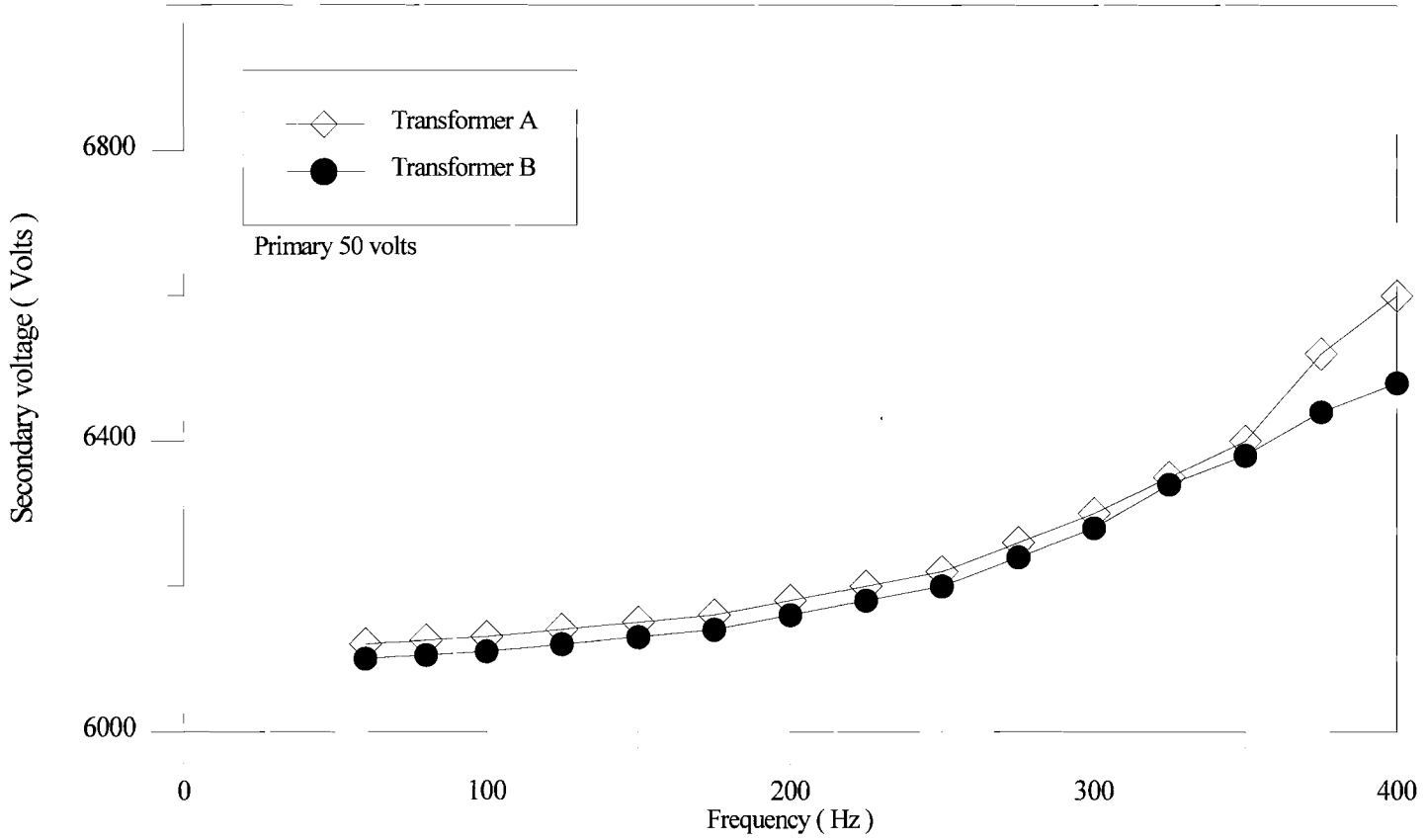

Figure4.2 Effect of Frequency on Secondary voltage in an Open Circuit Test

transformers give different characteristic curves the behavior of the curves is the same. However the secondary voltage does not show the same characteristics as power, as the frequency of the current is increased the secondary voltage increases. The increase in the secondary voltage is not linear. At high frequencies the increase in the secondary is exponential. The high magnitude of power and secondary voltage at 60 Hz is achieved because of the characteristics of the transformer. All transformers are manufactured for application at standard 120 V and 60 Hz for domestic. Hence the maximum at these values is observed. If the magnitude of the primary voltage is changed the magnitude of the secondary voltage also changes. Increase in the primary increases the secondary voltage and vice versa.

#### Effect of primary voltage and frequency on power and secondary voltage

Figures 4.3 and 4.4 show the effect of frequency and primary voltage on power and secondary voltage at a flow rate of 250cc/min through the ACPR. It can be observed from the figures that as the frequency of the AC is increased at a fixed primary of 70 volts from 60 Hz to 620 Hz the secondary voltage decreases rapidly from 8,600 V to 7,380 V, the frequency at 7,380 V point is 275 Hz. This is a point of minima for the secondary voltage at the above set primary. Further increases in the frequency cause an increase in the secondary voltage where the secondary increases to 8100 V at 330 Hz. The secondary voltage decreases rapidly for increasing frequency beyond 330 Hz. This behavior is caused by the plasma which is generated by the partial excitation of the molecules in the reactor. The sudden rise and fall in the secondary voltages in the range of 275 Hz to 330

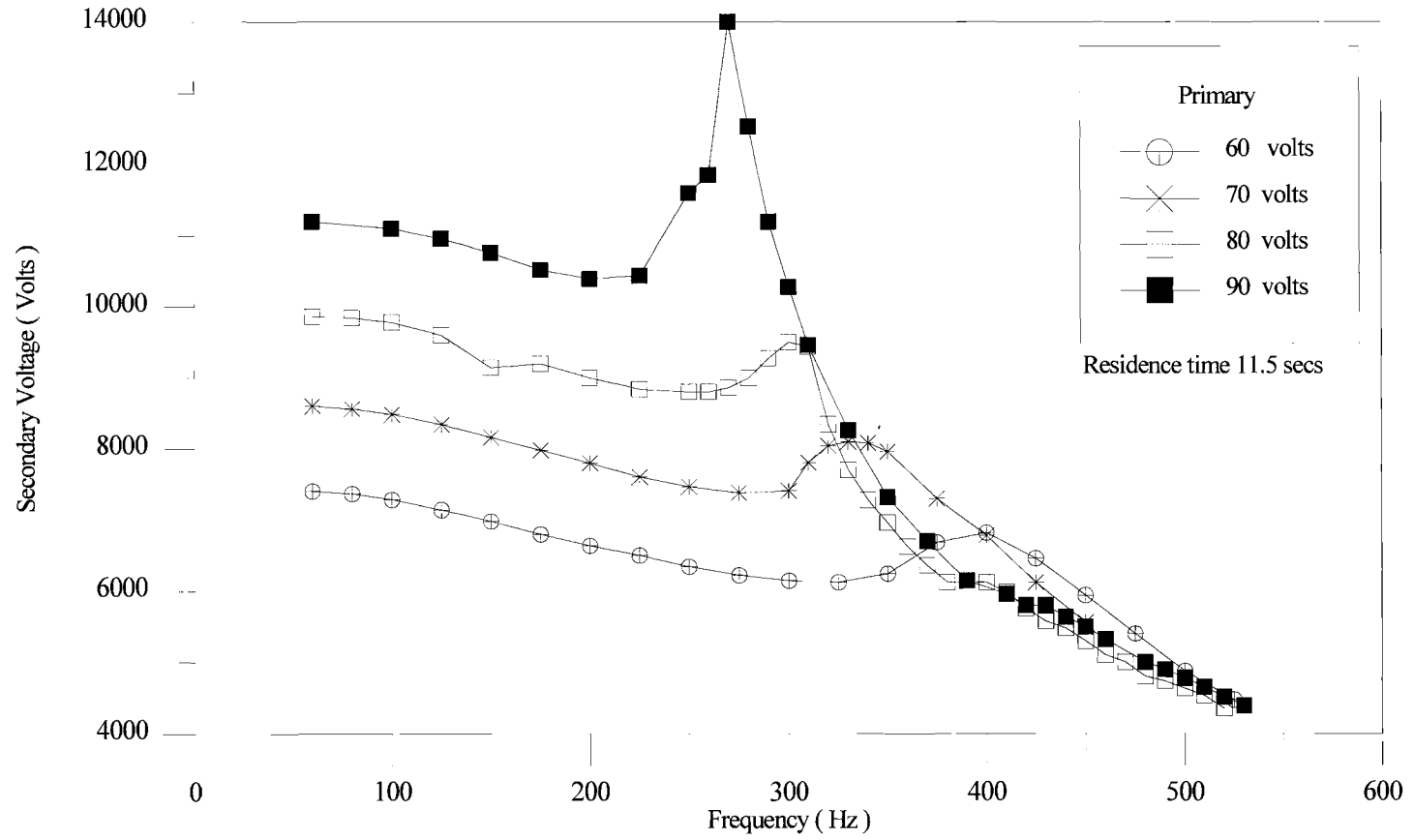

Figure 4.4 Effect of Primary voltage on Secondary voltage

Hz is due the formation of a plasma. At these values of secondary voltage and high frequency the molecules are pushed into an excited or a metastable state and a glow is observed that is concentrated at the walls of the reactor.

The curve for secondary voltage at 90 V of primary voltage has different characteristics than those of the curve at 70 V of primary. At 90 V of primary the secondary voltages are much higher than that at 70 V. Initially at 60 Hz the secondary voltage is 11,200 V and as the frequency is increased the secondary decreases steadily to 10,860 V at 260 Hz. For further increases in the frequency a sharp increase in the secondary voltage and a peak voltage of 14,000 V is attained at 270 Hz. Increasing the frequency beyond 270 Hz causes a sharp drop in the secondary voltage and the voltage decreases rapidly with each increment in the frequency thereafter. This behavior in the range of 270 to 310 Hz is caused by the breakdown of the gas. As the frequency is increased from 250 Hz the secondary also increases, this is caused by excitation of the electrons that move with the changing polarity of the reactor walls. Electrons start colliding with the gas molecules and by now have attained enough kinetic energy and have the ability to impart energy to the molecules and force them to reach an excited state. This signals onset of the plasma. Further increases in the frequency cause a complete breakdown of the excited molecules and create an avalanche of electrons and ions and results in high current flow through the (capacitor) reactor. It leads to a sharp increase in power and secondary voltage. Thus at breakdown we have high current flow which directly effects the power and the voltage through the reactor. In case a complete breakdown has not been achieved the secondary voltage peak has a smooth mound shape.

The slight increases in the secondary are due to the gases undergoing a partial breakdown only.

### Production of Nitrogen Oxides

Figures 4.5 and 4.6 show the amount of NO<sub>x</sub> produced in the ACPR for two flow rates of 100cc/min and 250cc/min respectively, at a primary voltage of 90 V. In Figure 4.5 it can be observed that at a residence times of 29 s and Figure 4.6 at a residence time of 11.5 s the secondary voltage and the power show the same behavior of sharp increase in the magnitudes at breakdown. Once a breakdown has been achieved secondary voltage and power decrease rapidly with frequency. However it is observed that the production of NO<sub>x</sub> is not maximum at the peak value of power and secondary voltage. In Figure 4.6 it can be observed that at breakdown the frequency is 280 Hz and the breakdown voltage is 14,000 V. The corresponding power is 220 W but the concentration is just 380 PPM which is much below the maximum concentration. As frequency of the AC is increased the secondary voltage and the power decrease but the concentration increases rapidly. At a maximum concentration of 1350 PPM the frequency is 480 Hz, the secondary voltage is 4500 V and the power drawn from the wall is just 100 W. It can be observed here that the frequency is an important parameter in the production of NO<sub>x</sub>. Increasing the frequency increases the rate at which the polarity of the electrodes changes. This increases the number of collisions an electron has with other ions and radicals. Increased collisions lead to formation of more nitrogen oxides. However high frequencies also decrease the magnitude of the secondary voltage. At low secondary voltages it is difficult to maintain the plasma. Once the plasma is lost a sudden and a sharp decrease in the formation of nitrogen oxides is observed.

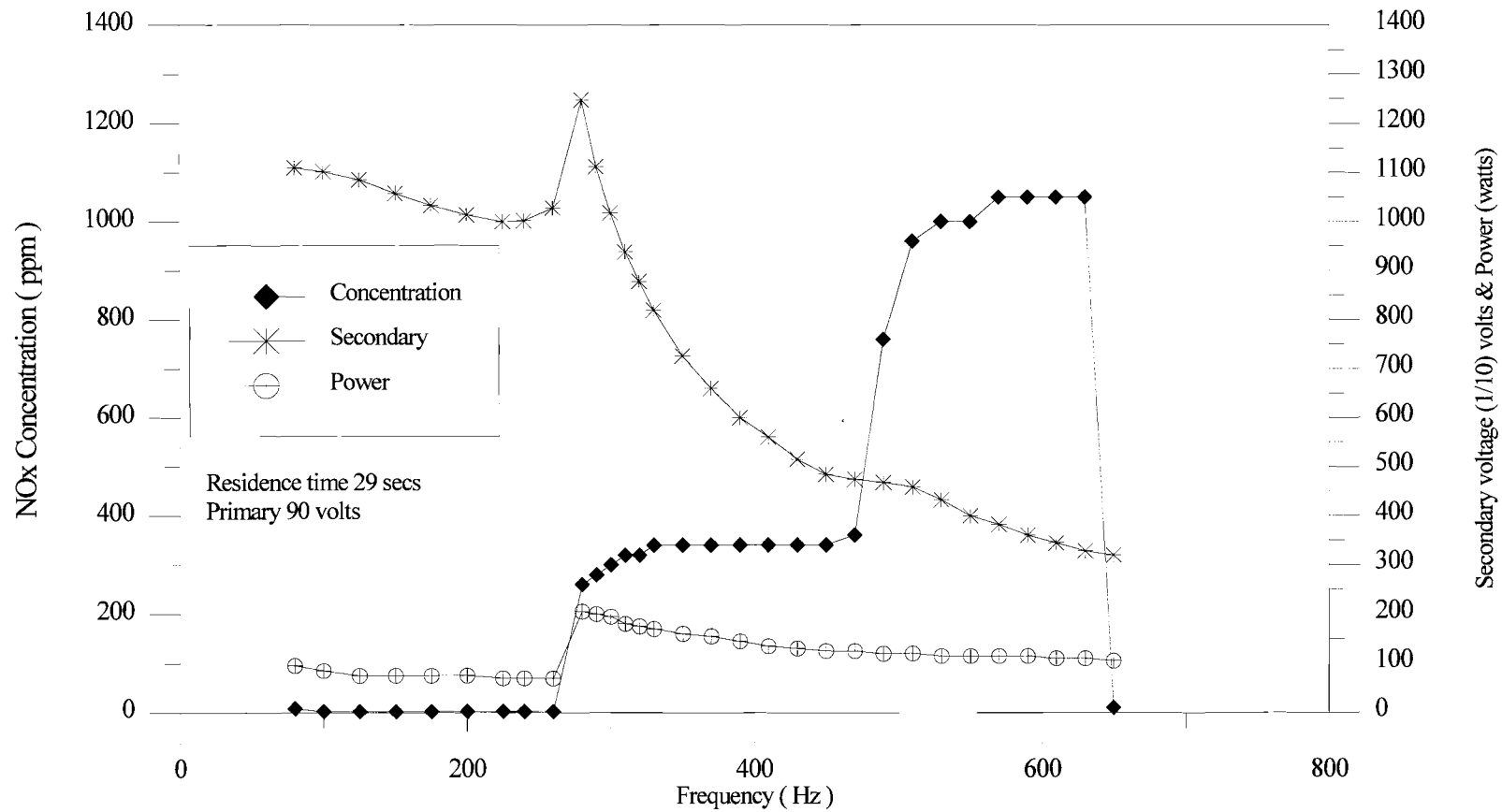

Figure 4.5 Effect of Frequency on Concentration, Secondary voltage and Power

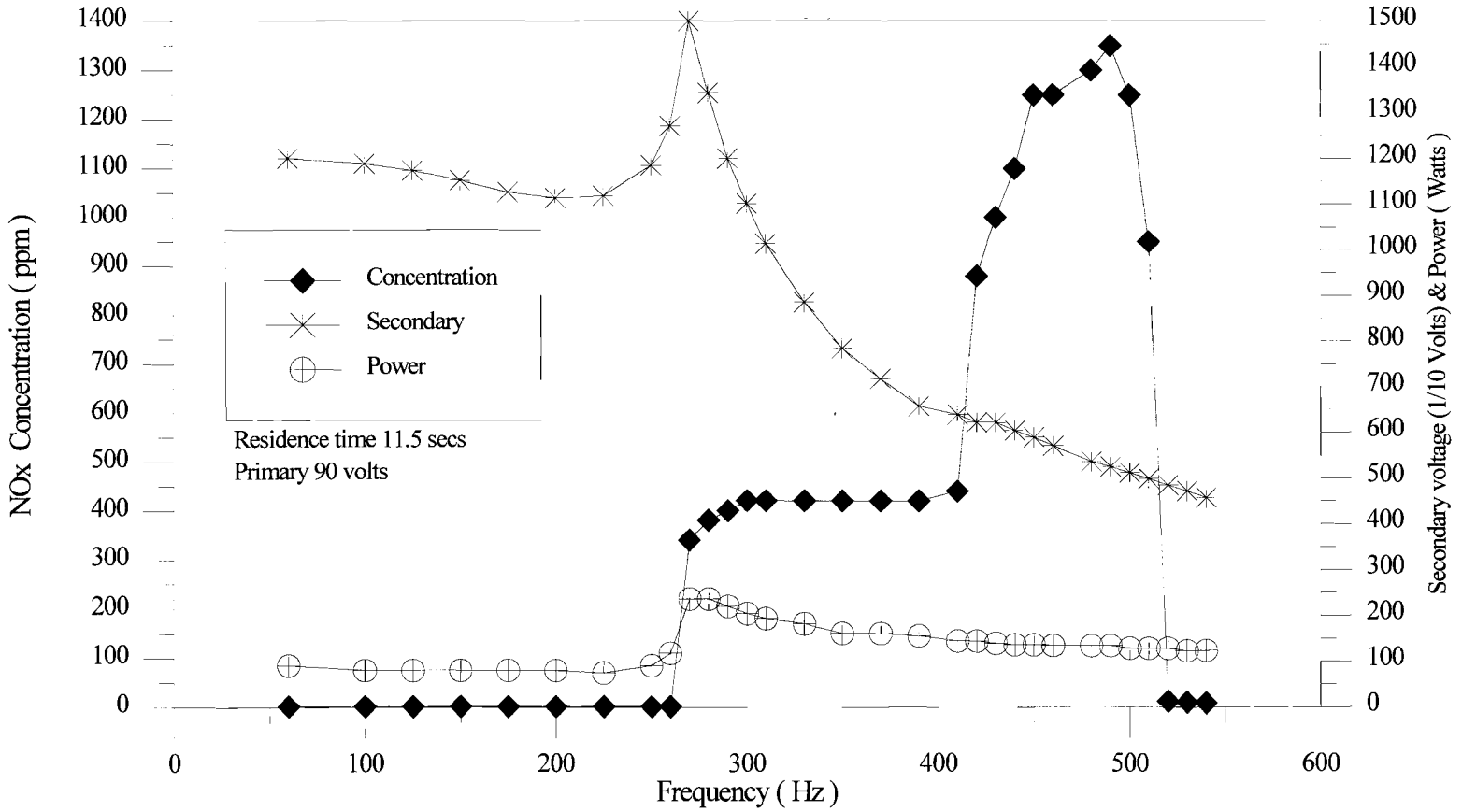

Figure 4.6 Effect of Frequency on Concentration, Secondary voltage and Power

### Effect of Primary voltage on production of Nitrogen Oxides

Figure 4.7 shows the effect of primary voltage on NO<sub>x</sub> production. It can be observed that the NO<sub>x</sub> production increases with an increase in the primary voltage. For a primary voltage of 80 V, the maximum NO<sub>x</sub> production is 1200 PPM and for 90 V it is 1350 PPM. The range of the frequencies also increases with an increase in the primary voltage. Therefore it can be inferred that for higher primary voltages the production of NO<sub>x</sub> can be achieved over a wider range of frequencies. This particular behavior can be attributed to the fact that at higher primary voltage the secondary voltage from the transformer, at a set frequency, is higher than that at lower primary voltages. Hence, breakdown of the gas is initiated at a lower frequency as the secondary voltage is high enough to initiate a breakdown of the gas, and as we increase the frequency of the alternating current the number of collisions resulting in the formation of products with neutral charges also increases. Primary directly influences the formation of nitrogen oxides. However primary voltages of 100 V or higher cause arcing across the electrodes of the reactor as the secondary voltage is high enough to breakdown the air in the space between the two electrodes.

### Effect of residence time on nitrogen oxide production

Figures 4.8 and 4.9 show the effect of varying residence time on production of nitrogen oxides at a primary voltage of 90 V. It can be observed from Figure 4.8 that for a residence time of 29 s the maximum NO<sub>x</sub> production is 1050 PPM. Although the initial breakdown of the gas occurred at 330 Hz the concentration of the gas does not increase until the frequency has increased to 490 Hz. In the range 490 to 620 Hz the



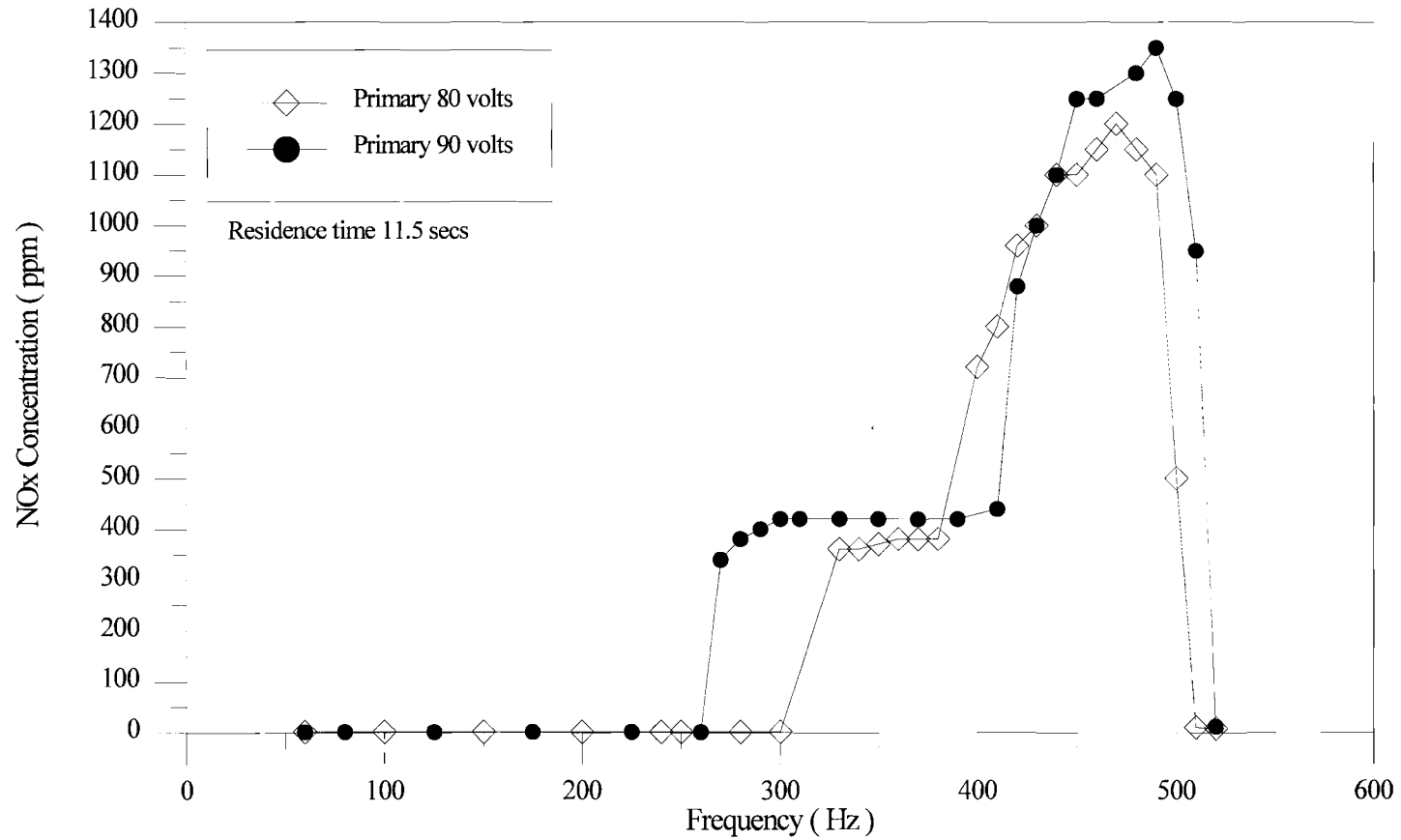

Figure 4.7 Effect of Primary voltage on Production of Nitrogen Oxides

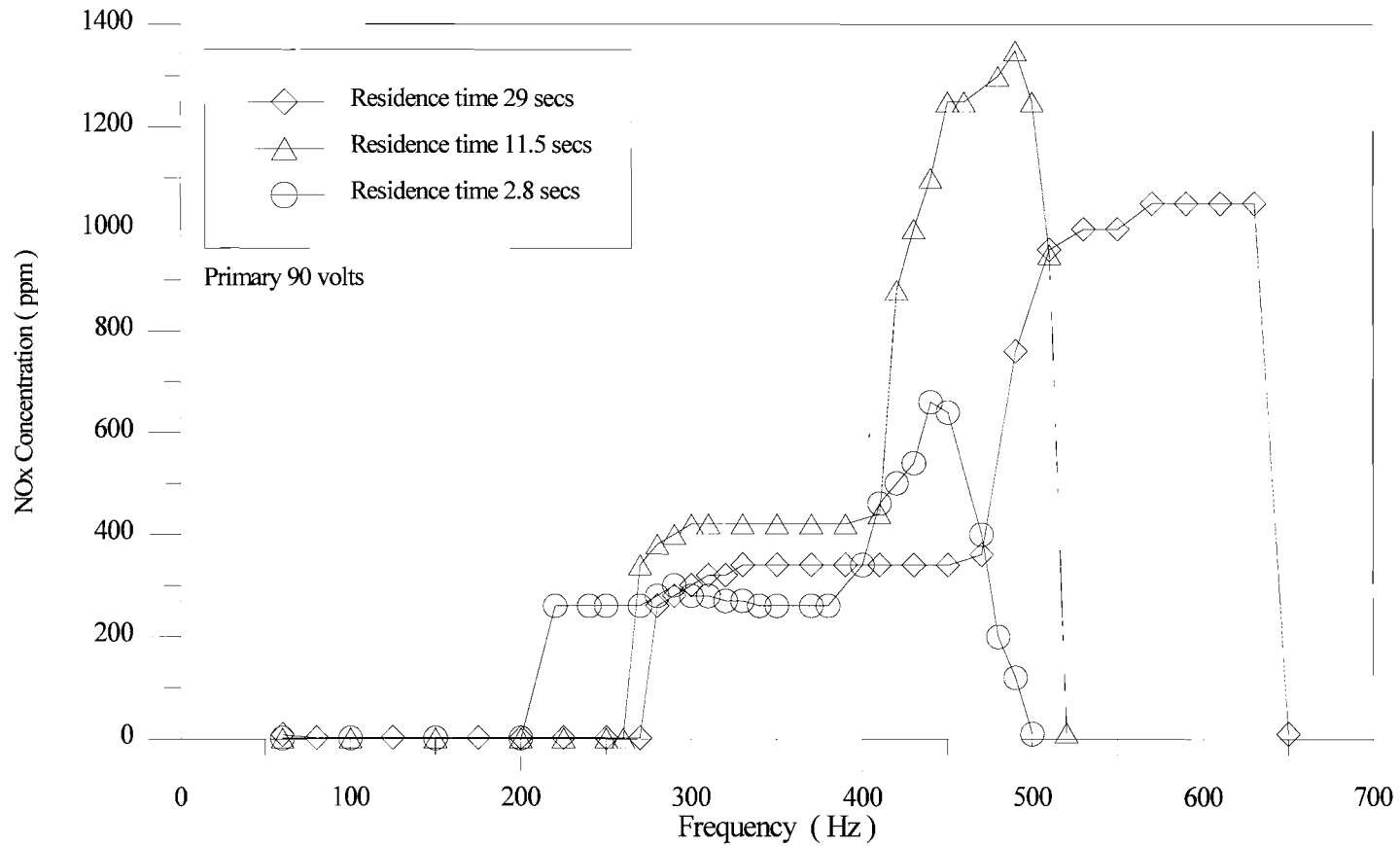

Figure 4.8 Effect of Residence Time on Production of Nitrogen Oxides

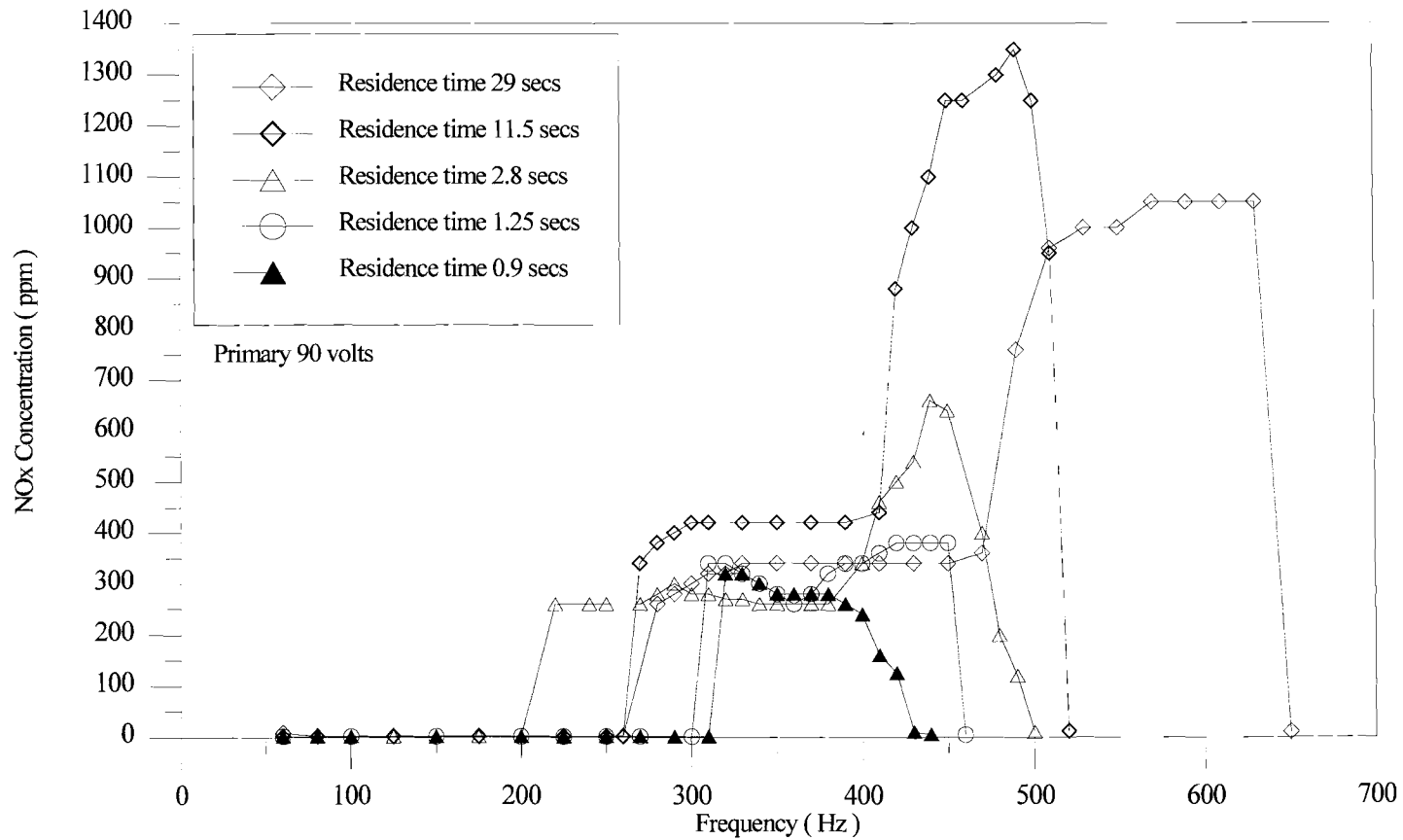

Figure 4.9 Effect of Residence on Production of Nitrogen Oxides

conversion to NO<sub>x</sub> is at a maximum and at 640 Hz it drops to the background level. At a residence time of 11.5 s the maximum concentration is 1350 PPM and the range of the frequency is 420 to 510 Hz. It seems for decreasing residence time the conversion is increased, but it can also be observed from Figures 4.8 and 4.9 that as the residence time is decreased to even lower values, the maximum concentration of nitrogen oxides decreases considerably. With each increase in the flow rate both the range of frequencies and the maximum concentration drop considerably. For higher flow rates the range of frequency over which nitrogen oxides are produced is lowered and also the maximum amount of nitrogen oxides is also decreased. It can be inferred that as the flow rate through the reactor is increased the conversion of air to oxides of nitrogen decreases. However at lower flow rates the conversion is influenced by the frequency of the current and also the breakdown voltages. For a residence time of 29 s the production of nitrogen oxides occurs at the higher frequency range. The maximum concentration is not at 29 s as expected because the recombination reactions at the tail end of the reactor cause breakdown of the oxides of nitrogen that could have been produced in the early stages. Since the gas molecules have enough time to undergo this reaction in the tail end of the reactor, the overall maximum concentration is lower than at a residence time of 11.5 s.

#### Effect of humidity on NO<sub>x</sub> production

Figures 4.10 and 4.11 show the effect of humidity on the production of nitrogen oxides. Figure 4.10 shows the effects of humidity on NO<sub>x</sub> production at high flow rate which gives a residence time of 1.11 s. For 0 % relative humidity the production of nitrogen occurs over range of frequency from 280 to 460 Hz and the maximum

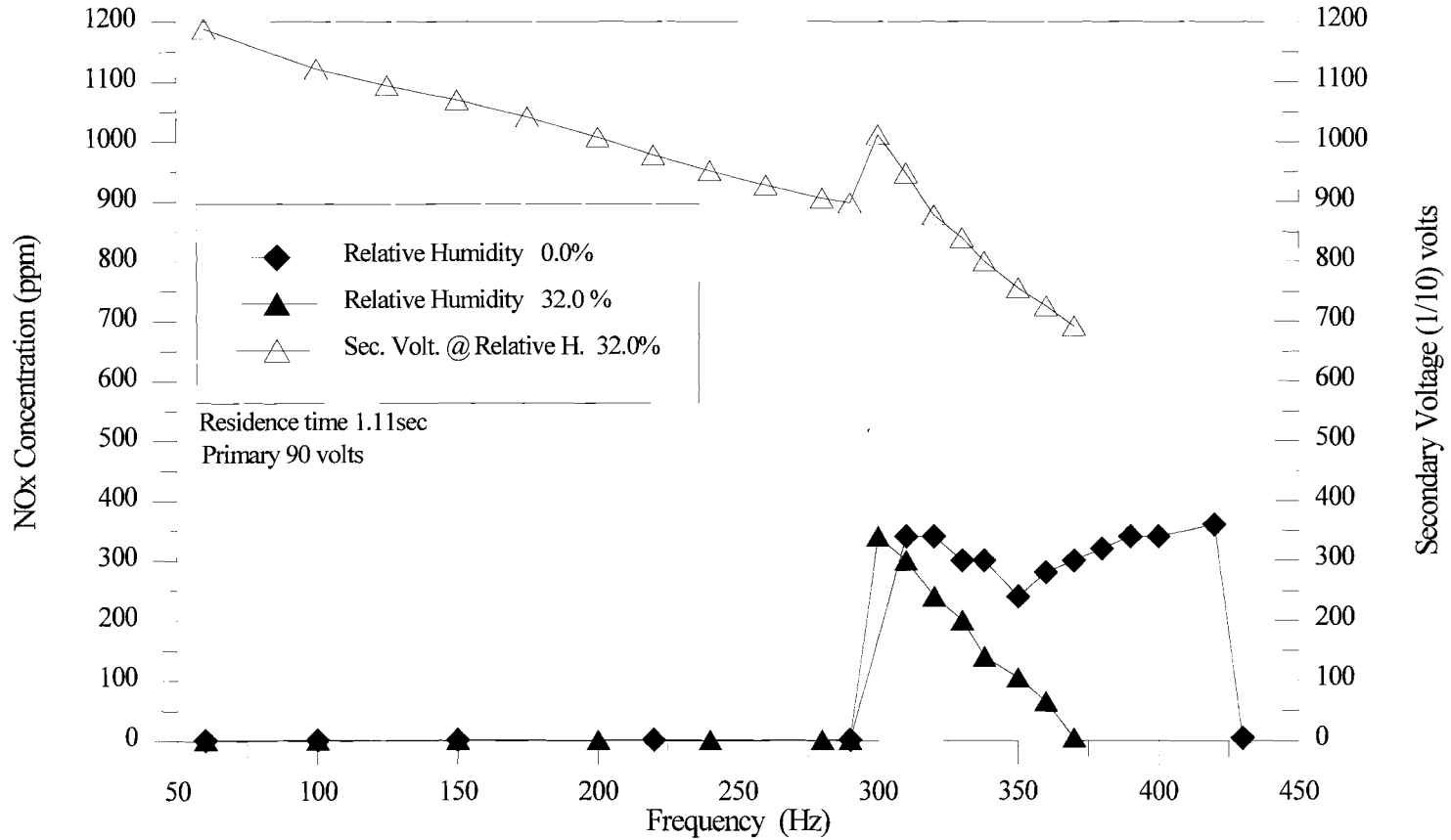

Figure 4.10 Effect of Humidity on NOx Production at Low Residence Time

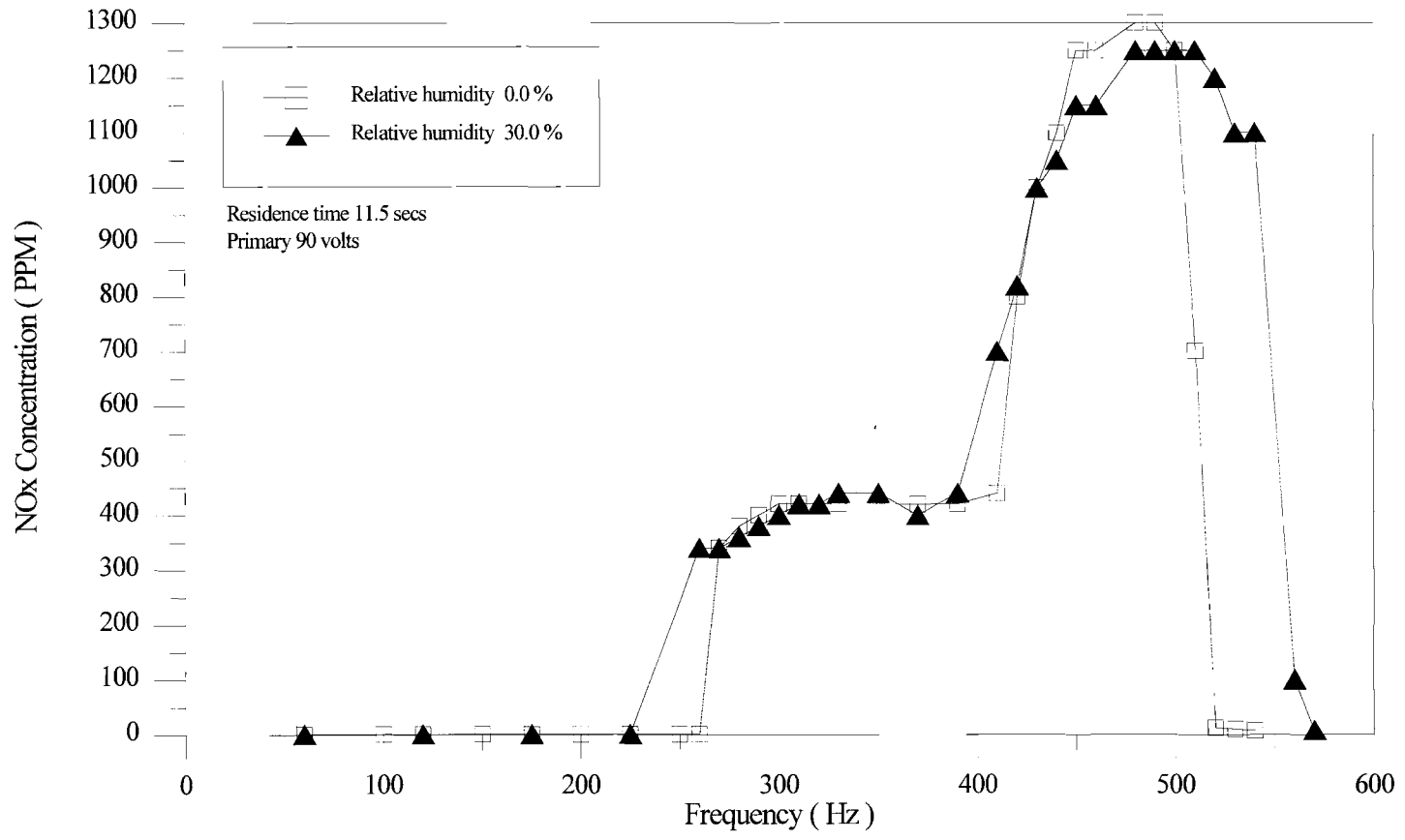

Figure 4.11 Effect of Humidity on Production of NOx at High Residence Time

production is 360 PPM. For the same flow rate and primary voltage if the humidity is increased to 32.0% the NO<sub>x</sub> production is inhibited by the presence of water in the gas. The production also occurs at a lower frequency of 260 Hz. The peak production decreases steadily with increasing frequency and the range of frequency is also narrowed. However for lower flowrates, the effect of humidity is opposite and for a residence time of 11.5 s and humidity of 30.0% NO<sub>x</sub> production occurs over a wider range of frequency. Under these conditions the peak production is almost the same as that at 0% relative humidity. It can be concluded that for higher flow rates humidity has an adverse effect on NO<sub>x</sub> production and for lower flow rates it increases the range of frequency over which the peak production of NO<sub>x</sub> occurs.

#### Effect of alternating current on nitrogen oxide production

There are three different types of alternating currents. AC can be a sine wave, square wave or a triangular wave. Each type imparts an electrical strength of different magnitude for a set primary voltage and frequency. Figure 4.12 shows the effect of sine wave and square wave on the production of nitrogen oxides. For a primary voltage of 90V and a residence time of 1.11s, it can be observed that the production of nitrogen oxides is not effected by the wave type. However the peak production of nitrogen oxides for a square wave are slightly lower than those for a sine wave. This effect is caused by the magnitude of secondary voltage. For a square wave alternating current the secondary voltage is lower than that for a sine wave.

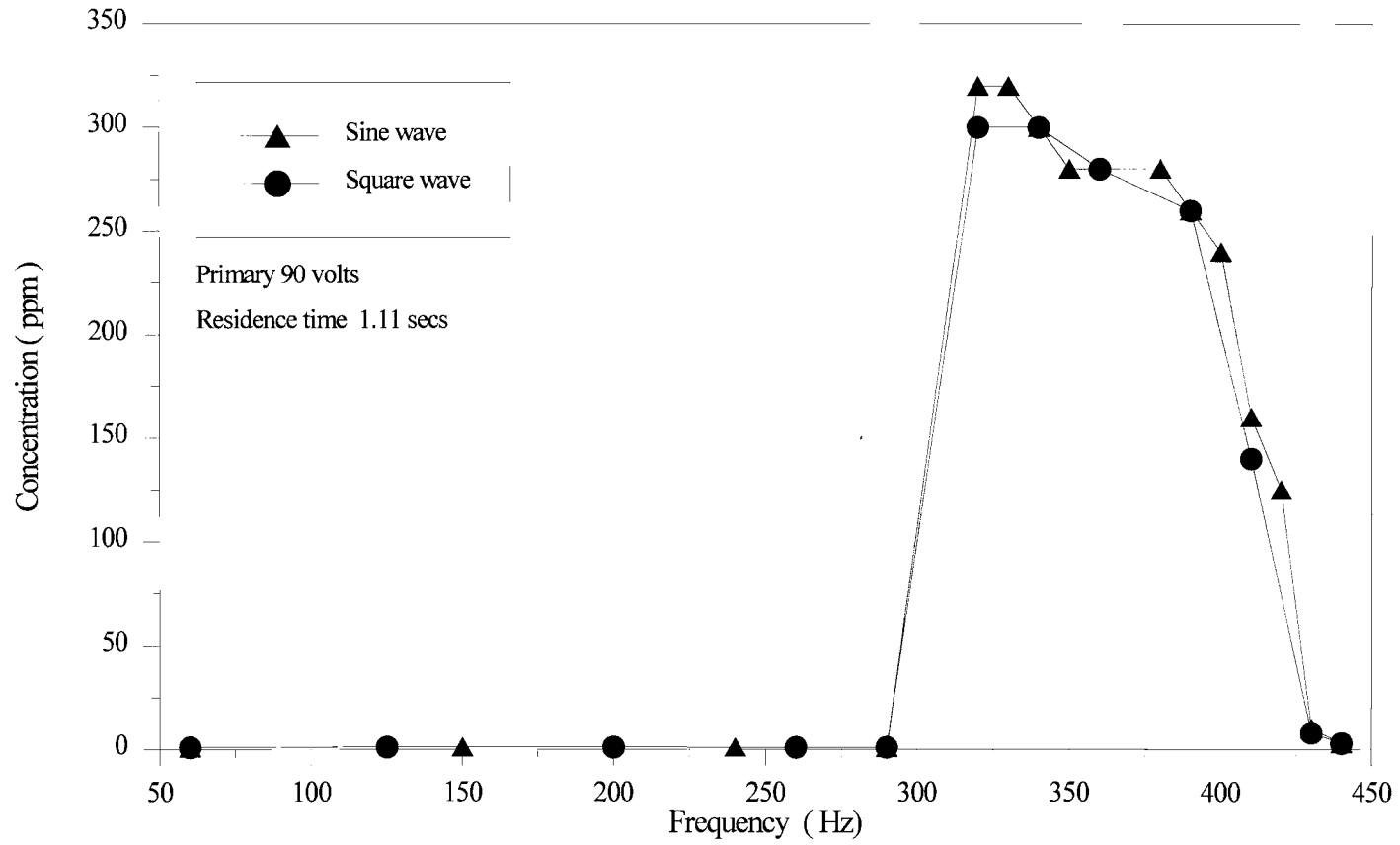

Figure 4.12 Effect of Alternating Current on Production of Nitrogen Oxides



## CHAPTER V

### CONCLUSIONS AND RECOMMENDATIONS

The following chapter discusses the conclusions that can be drawn from this study and, recommendations for future study are proposed.

#### Conclusions

1. The ACPR is sensitive to changes in the electrical characteristics. The electrical characteristics of the circuit are dependent on the transformer. If a transformer is replaced the entire circuit characteristics change. This is verified by the results from earlier tests done on the formation of nitrogen oxides at much lower primary voltages (3).

2. Residence time is an important parameter in an ACPR. For residence time of ten seconds and above the concentration of nitrogen oxides formed are much higher than those formed at a residence time close to one second. It can be inferred that hydrodynamics play an important role in the formation of reaction products in an ACPR. At high residence time higher concentration of nitrogen oxides is observed to favor high ranges of the frequency. This effect, however, is not observed at low residence times. It

can be concluded that for high residence time frequency is an important parameter that effects the formation of nitrogen oxides.

3. Minor increases in humidity have no significant effect on formation of nitrogen oxides. However at high residence time it does favor the formation of nitrogen oxides. Introduction of water in the reactor increases slightly the range of frequencies over which nitrogen oxides are formed. The peak concentrations are not effected. For low residence time humidity has an adverse effect on nitrogen oxides formed. The range of frequencies over which the reaction products are formed is narrowed.

The following recommendations are suggested for future research on the subject.

#### Recommendations

- For future research it is imperative to have a nitrogen oxide analyzer with higher sensitivity and faster response time.
- To have consistent results it is imperative to avoid changing the electrical characteristics of the circuit (i.e. transformer).
- To emulate plug flow conditions in the reactor it is necessary to have turbulent conditions in the annulus of the reactor, for future research it is recommended to conduct production tests at high Reynolds numbers
- Conducting runs at high primary voltage would definitely improve the formation of nitrogen oxides. To avoid arcing across the electrodes its important to insulate the ends of the electrodes.

- It is recommended to study the effect of temperature on the formation of nitrogen oxides. To increase the temperature and humidity the gas could be bubbled through hot water.
- The effect of introducing a catalyst that has the ability to release free electrons or ions should also be investigated.

### Observations

- The breakdown voltage equation can be used to design ACPRs. From experimental data it can be concluded that the breakdown of the gas can occur at much lower voltages than are estimated by the equation. The breakdown voltage equation (i.e. equation 2.2 ) in the modified form can only be used as a rough estimate of the breakdown voltages. We can set the annular gap to a certain value and calculate the breakdown voltage with this equation. If the calculated breakdown voltage however does not fall within the range of the transformer a new annular gap must be considered and the process repeated.
- A visible plasma establishes in the ACPR at a secondary voltage lower than the breakdown voltage. This effect can be attributed to molecules attaining a metastable state. This metastable state is initiated by the electrons that collide with the molecules after attaining a high kinetic energy. The kinetic energy of the free electrons is increased due to the high frequency of the alternating current and high energy electric field. A visible plasma is not a definite test for ascertaining the breakdown of the gas.

## BIBLIOGRAPHY

1. Chamberland, D., Knott, W., "Controlled Life Support System, Use of Plants for Human Life Support in Space," Florida Medical Journal, Sept. 1992.
2. Schwartzkopf, S. H., "Design of a Controlled Ecological Life Support System," Bioscience, 42 (7) 526-534, 1992.
3. Robinowitz, S., "Production of Nitrogen Oxides in Alternating Current Plasma Reactors," M.S. Thesis, Oklahoma State University, 1991.
4. Coffman, J.A., Browne, W.R., "Corona Chemistry," Scientific American, 212 (6) 91-98, 1965.
5. Tsai V., "Conceptual Design and Performance Analysis of Frequency Tuned Capacitive Discharge Reactors," Ph.D. Thesis, Oklahoma State University, 1991.
6. Manning, D.K., "Hydrocarbon Rearrangements and Synthesis Using an Alternating Current Silent Glow Discharge Reactors," M.S. Thesis, Oklahoma State University, 1993.
7. Boeing, H.V., "Plasma Science & Technology," Cornell University Press, 1982.
8. Piatt, M.A., "Methane Destruction in an Alternating Current Plasma Reactors," M.S. Thesis, Oklahoma State University, 1988.
9. Dibelius, N.R., Fraser, J.C., Kawahata, M. and Doyle, C.D., "Corona Processing of Coal," Chemical Engineering Progress, 60 (6) 40-41, 1964.
10. Desai, V.R., "Decomposition of Hydrogen Sulfide in Alternating Current, Frequency Tuned Plasma Reactors," M.S. Thesis, Oklahoma State University, 1992.
11. Fraser, M.E., Eaton, H.G., Sheinson, R.S., "Initial Decomposition Mechanisms and Products of Dimethyl Methylphosphate in an Alternating Current Discharge," Plasma Chemistry and Plasma Processing, 4 (1), 1984.
12. Weschler, C.J., "Indoor Ozone and Nitrogen Dioxide: A Potential Pathway to the Generation of Nitrate Radicals, Dinitrogen Pentaoxide, and Nitric Acid Indoors," Environmental Science and Technology, 26 (1) 179-184, 1992.
13. Bedell, F., "The principles of transformer," New York-Macmillian Company, 1968.

14. Seippel, R.G., "Fundamentals of Electricity" American Technical Publishers Inc., 1974.
15. Chen, F.F. "Introduction to Plasma Physics," Plenum Press, New York, 1974.
16. Johannes, A. H., (Oklahoma State University), Personal Communication.
17. Veenstra, J. N., (Oklahoma State University), Personal Communication.

## **APPENDICIES**

## Appendix A

Reynolds number calculations for two flow rates

$$N_{Re} = \frac{DV\rho}{\mu} = \frac{D_{eq}Q\rho}{\mu A_{cs}} = \frac{4Q\rho}{\mu\pi(D_o - D_i)}$$

$D_{eq}$  = Equivalent diameter of the annulus =  $D_o - D_i$

$D_o$  = Inner diameter of the outer tube = 3.2 cm

$D_i$  = Outer diameter of the inner tube = 2.2 cm

$Q$  = Flow rate of the gas cu.cm./sec

$\rho$  = Density of the gas =  $1.292 \times 10^{-3} \frac{\text{gm}}{\text{cm}^3}$

$\mu$  = Viscosity of the gas = .019 cp =  $.019 \times 10^{-2} \frac{\text{gm}}{\text{cm} \times \text{sec}}$

for 100 cc/min

$$N_{Re} = \frac{4 \times 100 \times 1.292 \times 10^{-3}}{3.142 \times 60 \times .019 \times 10^{-2}} = 14.42$$

for 2280.51 cc/min

$$N_{Re} = \frac{14.42 \times 2280.51}{100} = 328.51$$

## Appendix B

### Breakdown Voltage calculations for an ACPR

$V_b$  equation from equation 2.2

$V_b$

$$= \frac{10.96 \times 2.2 \times 1.0093}{(0.709 + 0.046(12 \times 2.54)^{0.5})} \left[ 1 + \frac{0.308}{(1.0093 \times 2.2)^{0.5}} \right] \times \left[ \frac{\ln\left(\frac{2.2}{2}\right)}{4.6} + \frac{\ln\left(\frac{3.2}{2.2}\right)}{1.0} + \frac{\ln\left(\frac{3.5}{3.2}\right)}{4.6} \right]$$

$$= 12.627 \text{ kV}$$

Relative density is calculated from the equation

$$\delta = \frac{3.921PZ}{273 + T}$$

$$P = 76.2 \text{ cm Hg}$$

$$Z = 1$$

$$T = 23 \text{ }^\circ\text{C}$$

$x = \text{length of the plasma zone} = \text{length of the reactor}$



Table C-1

Experimental data corresponding to Figures 4.1 & 4.2

A= Transformer A

B= Transformer B

Primary = 50 volts

<u>Frequency ( Hz )</u>	<u>A</u>		<u>B</u>	
	<u>Power (watts)</u>	<u>Secondary (volts)</u>	<u>Power (watts)</u>	<u>Secondary(volts)</u>
60	60	6140	60	6100
80	60	6160	60	6120
100	65	6180	65	6140
125	70	6200	65	6180
150	70	6240	65	6220
175	75	6290	70	6240
200	75	6340	70	6280
225	75	6380	70	6300
250	75	6460	70	6340
275	75	6480	70	6380
300	75	6520	70	6420
325	75	6580	70	6480
350	75	6640	70	6540
375	75	6700	70	6590
400	75	6760	70	6640

Table C-2

Experimental data corresponding to Figure 4.3

Flow rate = 250 cc/min

Relative humidity = 0.0%

Primary (volts)	60	70	80	90
Frequency (Hz)	Power (watts)			
60	70	75	85	85
80	65	70	75	
100	65	70	75	75
125	60	70	75	75
150	60	65	70	75
175	60	65	70	75
200	60	65	70	75
225	60	65	70	70
250	60	65		85
260			70	110
270				220
275	60	65		
280			75	220
290			75	205
295			80	
300	60	65	90	190
310			105	180
320		77	140	
325	60	77	145	
330		90	145	170
340			145	
350	60	90	145	150
360			140	
370			135	150

Table C-2 cont.

Primary Frequency	60	70	80	90
		Power		
375	65	95		
380			135	
390				145
400	80	95	125	
410			125	135
420			125	135
425	85	100		
430			122	130
440			122	127
450	85	100	122	127
460			120	125
470			120	
475	90	100		
480			115	125
490			115	125
500	90	100	115	120
510			110	120
520			110	115
525	90	100		
530	90			115
540	90			115

Table C-3

Experimental data corresponding to Figure 4.4

Flow rate = 250 cc/min

Relative humidity = 0.0 %

Temperature = 79 °F

Primary (volts)	60	70	80	90
Frequency (Hz)	Secondary (volts)			
60	7400	8600	9860	11200
80	7360	8560	9840	
100	7280	8480	9780	11100
125	7140	8340	9600	10960
150	6980	8160	9140	10760
175	6800	7980	9200	10520
200	6640	7800	9000	10400
225	6500	7600	8840	10440
250	6340	7460	8800	11600
260			8800	11860
270			8860	14000
275	6220	7380		
280			9000	12540
290			9280	11200
300	6140	7400	9500	10280
310		7800	9440	9460
320		8040	8340	
325	6120			
330		8100	7700	8260
340		8080	7280	
350	6240	7960	6960	7320
360			6620	

Table C-3 cont.

Primary	60	70	80	90
Frequency		Secondary		
370			6360	6700
375	6680	7300		
380			6120	
390				6140
400	6820	6780	6120	
410			5980	5960
420			5760	5800
425	6460	6120		
430			5580	5800
440			5480	5640
450	5940	5560	5300	5500
460			5100	5320
470			5000	
475	5400			
480			4800	5000
490			4740	4900
500	4880		4640	4780
510			4540	4660
520			4360	4520
525	4480			
530				4400

Table C-4

Experimental data corresponding to Figure 4.5

Flow rate = 100 cc/min

Relative humidity = 0.0%

Primary voltage = 90 volts

Frequency (Hz)	Concentration (ppm)	Secondary (volts)	Power(watts)
80	8	11100	95
100	2	11020	85
125	2	10860	75
150	2	10580	75
175	2	10340	75
200	2	10140	75
225	2	10000	70
240	2	10020	70
260	2	10280	70
280	260	12480	205
290	280	11120	200
300	300	10180	195
310	320	9380	180
320	320	8780	175
330	340	8200	170
350	340	7260	160
370	340	6600	155
390	340	6000	145
410	340	5600	135
430	340	5140	130
450	340	4840	125
470	360	4740	125
490	760	4680	120
510	960	4580	120

Table C-4 cont.

Frequency	Concentration	Secondary	Power
530	1000	4320	115
550	1000	4000	115
570	1050	2380	115
590	1050	3600	115
610	1050	3440	110
630	1050	3280	110
650	10	3200	105

Table C-5

Experimental data corresponding to Figure 4.6

Flow rate = 250 cc/min

Relative humidity = 0.0%

Primary voltage = 90 volts

Frequency (Hz)	Concentration (ppm)	Secondary (volts)	Power (watts)
60	1	11200	85
100	1	11100	75
125	1	10960	75
150	1	10760	75
175	1	10520	75
200	1	10400	75
225	1	10440	70
250	1	11060	85
260	1	11860	110
270	340	14000	220
280	380	12540	220
290	400	11200	205
300	420	10280	190
310	420	9460	180
330	420	8260	170
350	420	7320	150
370	420	6700	150
390	420	6140	145
410	440	5960	135
420	880	5800	135
430	1000	5800	130
440	1100	5640	127
450	1250	5500	127



Table C-5 cont.

Frequency	Concentration	Secondary	Power
460	1250	5320	125
480	1300	5000	125
490	1350	4900	125
500	1250	4780	120
510	950	4660	120
520	12	4520	120
530	10	4400	115
540	8	4260	115

Table C-6

Experimental data corresponding to Figure 4.7

Flow rate = 250 cc/min

Relative humidity = 0.0%

Primary voltage (volts)	80	90
Frequency (Hz)	Concentration (ppm)	
60	1	1
80	1	
100	1	1
125	1	1
150	1	1
175	1	1
200	1	1
225	1	1
240	1	
250		1
260	1	1
270		340
280	1	380
290		400
300	1	420
310	1	420
320		340
330	360	420
340	360	
350	370	420
360	380	
370	380	420
380	380	

Table C-6 cont

Primary Frequency	80 Concentration	90
390		420
410	800	440
420	960	880
430	1000	1000
440	1100	1100
450	1100	1250
460	1150	1250
470	1200	
480	1150	1300
490	1100	1350
500	500	1250
510	10	950
520	8	12

Table C-7

Experimental data corresponding to Figures 4.8 &amp; 4.9

Primary voltage = 90 volts

Flow rate (cc/min)	100	250	1000	2280	3109
Frequency (Hz)	Concentration (ppm)				
60	8	1	1	1	1
80	2	1	1	1	1
100	2	1	1	1	1
125	2	1	1	1	1
150	2	1	1	1	1
175	2	1	1	1	1
200	2	1	1	1	1
220			260	1	1
225	2	1		1	1
240	2		260	1	1
250		1	260	1	1
260	2	1		1	1
270		340	260	1	1
280	260	380	280	1	1
290	280	400	300	1	1
300	300	420	280	1	1
310	320	420	280	340	1
320	320		270	340	320
330	340	420	270	320	320
340			260	300	300
350	340	420	260	280	280
360				260	280
370	340	420	260	280	280
380			260	320	280
390	340	420		340	260

Table C-7 cont.

Flow rate	100	250	1000	2280	3109
Frequency	Concentration				
400			340	340	240
410	340	440	460	360	160
420		880	500	380	125
430	340	1000	540	380	10
440		1100	660	380	5
450	340	1250	640	380	
460		1250		5	
470	360		400		
480		1300	200		
490	760	1350	120		
500		1250	10		
510	960	950			
520		12			
530	1000				
550	1000				
570	1050				
590	1050				
610	1050				
630	1050				
650	10				

Table C-8

Experimental data corresponding to Figure 4.10

Flow rate = 2578.9 cc/min, Primary = 90 volts

Relative humidity	0.0%	32.0%	
Frequency		Concentration(ppm)	Secondary V(volts)@32.0%
60	1	1	11880
100	1		11220
125	1	1	10940
150	1	1	10700
175	1		10420
200	1	1	10080
220	1	1	9780
240	1	1	9520
260	1	1	9280
280	1	1	9060
290	1	1	8980
300	1	340	10120
310	340	300	9480
320	340	240	8780
330	300	200	8400
338	300	65	8000
370	300	5	7560
380	320		
390	340		
400	340		
420	360		
430	5		

Table C-9

Experimental data corresponding to Figure 4.11

Flow rate = 250 c/min, Primary = 90 volts

Relative humidity	0.0%	30.0%
Frequency (Hz)	Concentration	
60	1	1
100	1	1
125	1	1
150	1	1
175	1	1
200	1	1
225	1	1
250	1	1
260	1	340
270	340	340
280	380	360
290	400	380
300	420	400
310	420	420
320		420
330	420	440
350		440
370	420	400
390	420	440
410	440	700
420	800	820
430	1000	1000
440	1100	1050
450	1250	1150

Table C-9 cont.

Relative humidity	0.0%	30.0%
Frequency	Concentration	
460	1250	1150
480	1300	1250
490	1300	1250
500	1250	1250
510	700	1250
520	12	1200
530	10	1100
540		1100
560		100
570		



# VITA /

Gurbrinder S. Sidhu

Candidate for the Degree of

Master of Science

Thesis: Production and Destruction of Nitrogen Oxides in Alternating Current Plasma Reactors

Major Field: Chemical Engineering

## Biography:

Personal Data: Born in Sri Ganganagar, India, June 15, 1968

Education: Graduated from S.G.N.P. High School, Chandigarh, India, May 1984; received Bachelor of Engineering Degree in Chemical Engineering from Panjab University Chandigarh, India, October, 1990; completed requirements for the Master of Science degree at Oklahoma State University in May 1995.

Professional Experience: Teaching Assistant Oklahoma State University, Research Assistant Tennessee Tech. University, Cookeville, Tennessee, Engineering Consultant, Consolidated Surveyors, Chandigarh, Production Engineer United Vanaspati, Chandigarh, Intern Engineer, United Vanaspati.