

EVALUATION OF THE RECIPROCATING  
PLATE COLUMN FOR TREATING  
PETROLEUM WASTE WATERS

By

RAMASUBRAMANIAN RAJAGOPAL

Bachelor of Engineering [Chemical]

Annamalai University

Chidambaram, Tamil Nadu

India

1991

Submitted to the Faculty of the  
Graduate College of the  
Oklahoma State University  
in partial fulfillment of  
the requirements for  
the Degree of  
MASTER OF SCIENCE  
May 1994

EVALUATION OF THE RECIPROCATING  
PLATE COLUMN FOR TREATING  
PETROLEUM WASTE WATERS

Thesis Approved:

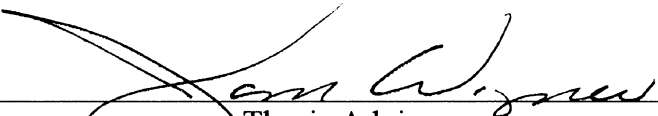
  
\_\_\_\_\_  
Thesis Adviser

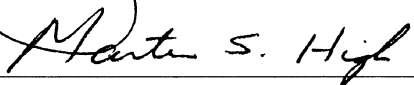
  
\_\_\_\_\_

  
\_\_\_\_\_

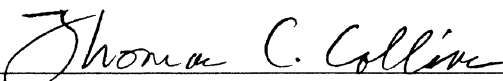
  
\_\_\_\_\_  
Dean of the Graduate College

## ACKNOWLEDGMENTS

I would like to extend my sincere appreciation to Dr. Jan Wagner for his advice and encouragement in completing my thesis. Many thanks to Dr. Alan Tree, Dr. Arland Johannes, and Dr. Martin High for serving on my committee. I would like to thank the staff of Chemical Engineering for their help, especially Charles Baker, without whom setting up my experiment would have been impossible.

To my friends Sam, John, Zeny, and the many others who extended their encouragement to me, my sincere gratitude. Many thanks to Chen, Wilson, and Manning for their helpful suggestions.

I would like to thank my parents, Rajagopal and Vanitha, and my brother Babu, for their patience and moral support in helping me achieve my goals. I dedicate this thesis to them.

## TABLE OF CONTENTS

Chapter	Page
I. INTRODUCTION.....	1
II. LITERATURE SURVEY .....	3
Treatment Methods.....	3
Carbon Adsorption .....	3
Air or Steam Stripping.....	4
Biological Treatment.....	5
Incineration .....	5
Solvent Extraction .....	6
Selection of Extractor.....	7
Solvent Selection.....	9
III. SCOPE AND OBJECTIVES .....	10
IV. EXPERIMENTAL SETUP AND ANALYTICAL TECHNIQUES ....	13
Experimental Setup .....	13
Analytical Techniques.....	18
Cleaning Procedure .....	18
Sample Concentration .....	21
Ternary System .....	21
Waste Water Streams .....	21
GC Analysis.....	22
Ternary System.....	22
Waste Water Streams.....	26
Chemicals.....	26
Equilibrium Data .....	26
Operating Procedure .....	28
Synthetic Waste Water .....	28
Waste Water Treatment.....	29

V. RESULTS AND DISCUSSION.....	30
Equilibrium Data .....	30
Extractor Performance .....	31
Column Evaluation .....	33
Experimental Errors and Error Propagation .....	34
Range of Variables .....	35
Flow Characteristics .....	36
Effect of Variables.....	39
Solvent Ratio .....	39
Flow Rates.....	42
Choice of Dispersed Phase .....	48
VI. CONCLUSIONS AND RECOMMENDATIONS.....	52
Conclusions .....	52
Recommendations .....	53
BIBLIOGRAPHY .....	54
APPENDICES.....	60
APPENDIX A - ERROR ANALYSIS.....	61
APPENDIX B - EQUILIBRIUM DATA .....	67

## LIST OF TABLES

Table	Page
1. Summary of GC Details and Operating Conditions .....	23
2. Summary of Extraction of Ternary System Pentane- Benzene-Water .....	37
3. Summary of Runs on Desalter Water .....	38
A1. Relative Estimated Errors in the HETS.....	64
A2. Estimated Error in the Percentage Reduction of Benzene.....	65
A3. Estimated Error in the Overall Removal Efficiency of Organics from Desalter Water .....	66
B1. Equilibrium Distribution Data of Benzene between Pentane and Water .....	68
B2. Distribution Data for Acetic Acid between MIBK and Water (Karr, 1950).....	69

## LIST OF FIGURES

Figures	Page
1. Reciprocating Plate Column Details .....	14
2. Perforated Plate.....	16
3. Flowsheet of Extraction Apparatus .....	17
4. Calibration Curve of Rotameter [R1] for Water Flow Rate.....	19
5. Calibration Curve of Rotameter [R2] for Pentane Flow Rate .....	20
6. Calibration Curve for GC Analysis for Pentane-Ethylbenzene.....	24
7. Calibration Curve for GC Analysis for Benzene-Ethylbenzene....	25
8. Calibration Curve for GC Analysis for Methylene Chloride-Toluene.....	27
9. Distribution Curve for Benzene between Pentane and Water .....	32
10. Effect of Solvent Ratio on the HETS .....	40
11. Effect of Solvent Ratio on the Removal Efficiency .....	41
12. Effect of Solvent Ratio on the Removal Efficiency for Desalter Water .....	43
13. Effect of Flow Rates on the HETS .....	44

14. Effect of Flow Rates on the Removal Efficiency .....	46
15. Effect of Flow Rate on the Removal Efficiency for Desalter Water .....	47
B1. Determination of Number of Theroretical Stages by Graphical Interpolation .....	70



## CHAPTER I

### INTRODUCTION

Petroleum refineries generate considerable quantities of waste water. Regulations regarding the water quality of effluents are developed under the Environmental Protection Agency's (EPA) National Pollutant Discharge Elimination System (NPDES) permitting program. These regulations were historically based on treatment technologies, but are now based on effluent water quality and must be met regardless of the treatment technologies available.

Most waste water streams must be pretreated prior to discharge. The conventional methods of pretreatment are primary and secondary treatment. Primary treatment consists of oil/water/solids separations and may be accomplished by gravity (primary separation) or physical/chemical means (secondary separation). Secondary treatment utilizes biological degradation of the wastes.

In addition to NPDES regulations, waste waters now come under additional regulations such as hazardous waste regulations under the Resource Conservation and Recovery Act (8), waste water Hazardous Organic Neshaps (National emission standards for hazardous air pollutants) for Group I waste waters (12) and Volatile Hazardous Air Pollutants.

These regulations require that the effluent water streams do not contain toxic and hazardous contaminants above a prescribed threshold.

Effluent water from crude desalting units mainly contains hydrocarbons, soluble salts and suspended solids. Benzene is one of the primary contaminants present in desalter water and is controlled by all the regulations mentioned earlier. The acceptable concentrations of benzene in waste waters vary from 10 ppm to 0.5 ppm. Although not currently listed, desalter water is to be characterized by the EPA by 1996 (48).

Solvent extraction is one of the technologies identified by the EPA as a Best Demonstrated Available Technology (BDAT) to treat wastes. Extraction has occasionally been used to remove organic pollutants, primarily phenols, in waste waters. The predominant factors for the limited application of solvent extraction are i) loss of solvent due to its solubility in the product water, ii) higher capital costs compared to methods such as biological treatment, and iii) operating costs involved in solvent regeneration. Solvents having low water solubility and high partition coefficients for organic solutes would almost eliminate solvent loss in the purified water stream and also reduce the quantity of solvent required. The reduction in the quantity of solvent would result in lower operating costs. Pentane and hexane have been shown to be effective in treating desalter water (6). The Karr Reciprocating Plate Column (RPC) can handle very low solvent to water flow rates (21). In this work, preliminary studies on a synthetic waste water containing benzene and a desalter water effluent were carried out in a bench scale RPC using pentane as the solvent.

## CHAPTER II

### LITERATURE SURVEY

#### Treatment Methods

The methods of treating organic contaminants in waste waters can be broadly classified as recovery and non-recovery methods. Recovery methods include steam stripping, carbon adsorption with caustic washing, and solvent extraction. Non-recovery methods include biological oxidation, carbon adsorption with thermal oxidative regeneration, incineration, and deep well injection. Some of the widely used treatment methods are discussed below.

#### Carbon Adsorption

Carbon adsorption is a treatment process wherein the organics present in the waste water are physically attached to the surface of activated carbon particles. The effectiveness of carbon adsorption depends on characteristics of the compound such as polarity, water solubility, aromaticity, and chain length. Powdered activated carbon is used in biological treatment methods for spot treatment of organic surges. Granular activated carbon beds are also available. The major drawback of this method is that the contaminants are transferred from the liquid to the solid phase. The carbon must be regenerated or replaced, depending on the

particular case under consideration. If the carbon to be regenerated is also classified as an F waste under RCRA listing, then regeneration may not be a viable option, due to the additional compliance requirements.

### Air or Steam Stripping

Stripping is used to treat waste streams containing volatile organics. The feasibility for a compound to be air stripped can be determined from its Henry's Law constant. In general, contaminants having high Henry's Law constants are easily stripped. There are high capital costs associated with this method, with the major cost being associated with the tower. A problem with this method is similar to the one encountered in carbon adsorption. The contaminants are transferred from the liquid phase to the vapor phase, resulting in a significant source of air pollution. Regulations pertaining to air quality standards must be considered. One way to avoid this problem would be to use the gas for combustion in boilers. However, the presence of chlorinated organics could lead to the formation of hydrochloric acid in the flue gas which would require air emission permits and controls. An alternative would be to use steam stripping which has the added benefit of increasing the value of Henry's Law constant as a result of elevated temperatures, thereby ensuring better separation of the volatile components from the aqueous phase. The steam with the stripped volatiles could then be condensed, resulting in a stream which has basically been concentrated. This would serve to reduce the treatment costs for the resulting wastes.

## Biological Treatment

In biological treatment, the organic contaminants are converted into biomass, carbon dioxide, non-biodegradable organic byproducts, and water. The treatment process can be carried out under either aerobic or anaerobic conditions.

There are two major categories of biological treatment processes: fixed film and suspended growth systems. In fixed film systems, the microorganisms attach themselves to an inert support medium. Common forms of aerobic fixed film processes are biological towers (or trickling filters) and rotating biological contactors. In suspended growth systems, microorganisms are present in a basin as suspended material to which the waste water is added. Air is introduced by means of aerators. The biological flocs are later separated by gravity settling. Activated sludge, facultative lagoons and anaerobic lagoons are examples of suspended growth systems. In general, fixed film systems are more efficient and do not require aerator equipment as opposed to the suspended growth systems. These factors result in lower costs for the fixed film systems. In biological process, care should be taken as to the consistency of the level of contaminants in the waste water streams. The microorganisms cannot handle large quantities of hydrocarbons in the water streams. Hence, a pretreatment stage may be required to eliminate or reduce the possibility of surges in hydrocarbon levels in the receiving streams.

## Incineration

This is a very efficient method for the disposal of waste streams. The major drawbacks are high capital costs and the fact that RCRA permits must be obtained for the resulting vapor emissions. Current air emission

regulations point toward increasingly stringent standards. Hence, additional control may be necessary for compliance.

### Solvent Extraction

This has been identified as one of the BDAT methods for the treatment of hazardous wastes. It consists essentially of contacting the waste stream with a solvent which exhibits high partition coefficients for the contaminants present in the aqueous stream. The resulting immiscible mixture is separated and the extract can either be recycled after regeneration or sent to an upstream process directly.

One of the advantages of solvent extraction is that it is a recovery process. This eliminates several problems associated with destruction processes; primarily the treatment of generated wastes, which would still be regulated. Further, extracted organics can be recycled upstream, minimizing hydrocarbon losses in the waste water streams. Solvent extraction processes are not affected by variations in feed stream concentrations, which can be detrimental to biological treatment methods.

Solvent extraction has conventionally been used to remove organic pollutants from aqueous streams in several processes (11, 14, 26, 28, 31, 34, 45, 46, 48, 53, 54). By far, the most common process to which it has been applied is for the removal of phenols from water. The by-product coke industry has extensively used solvent extraction to treat phenolic wastes by the Phenosolvan process (11). Wastes from catalytic cracking operations were treated by the Phenex process which used light catalytic oil (11). Earhart et al (11) studied solvent extraction using volatile solvents to treat seven different industrial waste waters using simple extraction and dual stage extraction. Dual solvent extraction consists of contacting the

waste waters with a polar solvent having high distribution coefficients for the organic contaminants. The second solvent, which is nonpolar and hence has low water solubility, is then used to extract the polar solvent. This arrangement permits the use of low solvent to water flow ratios. Extraction has also been successful in removing inorganic contaminants from water streams (36).

### Selection of Extractor

The selection of extractors is complicated by the many types of contacting equipment available commercially for extraction processes. Several factors have to be taken into account when choosing the extractor. They include the number of stages required, the flow rates, residence times, physical properties, emulsifying tendencies, direction of mass transfer, maintenance, etc. As described by Robbins (44), "the least complicated contactor which will perform the extraction with low maintenance is preferred for the industrial process."

The selection of the contactor, in addition to the above factors, also has to take into account the overall process. For example, factors such as the cost of solvent recovery and raffinate stripping to remove the excess solvent have to be considered. Although a large ratio of solvent to water might reduce the number of stages, it results in a large quantity of solvent to be regenerated. Solvents are usually regenerated by distillation and this entails higher operating costs. This increase in operating costs, however, more than offsets the savings resulting from reducing the number of stages (32). Hence, it is preferred to operate with a large number of stages as it substantially reduces the cost of solvent recovery. The waste water streams to be treated also display emulsifying tendencies.

The Karr reciprocating plate column (RPC) was chosen for treating the waste water streams. Some salient features of the RPC are

1. Large throughput
2. High mass transfer rate
3. High volumetric efficiency
4. Treats emulsifiable materials
5. Handles solids
6. Low energy needed for reciprocation
7. Straight forward scale-up procedure
8. Simple construction
9. Wide range of operating conditions
10. Low cost and low maintenance.

The column consists of a stack of perforated plates mounted on a shaft and reciprocated by a motor. Performance data on RPCs of various sizes are available (20, 21, 23, 24, 25, 32, 33, 43). The RPC compares very favorably with other contactors in terms of volumetric efficiency and throughput. The volumetric efficiency is defined as

$$\text{Volumetric Efficiency} = \frac{\text{Throughput}}{\text{HETS}}$$

where the throughput is the combined flow of the two phases, in  $ft^3 / ft^2 hr$ , and HETS is the height equivalent to a theoretical stage, in  $ft$ .

A 12 inch diameter column gave a minimum HETS of 6.12 inches and a volumetric efficiency of 311 per hour for the system methyl isobutyl ketone (MIBK)-acetic acid-water (20). For the *o*-xylene-acetic acid-water system, a minimum HETS of 20 inches was obtained with a 36 inch



diameter column (21). Studies on the hydrodynamics and axial mixing of RPCs have been reported by Baird et al. (3, 4, 16, 22, 27, 50).

### Solvent Selection

Low solvent to water flow rates are desirable as this would result in lower operating costs. Nonpolar solvents have low water solubilities resulting in negligible solvent loss. Aromatic hydrocarbons were not chosen due to their toxic nature and higher water solubility. Earhart et al. (11) used isobutylene and isobutane for the simple extraction and dual stage extraction in treating seven different industrial waste waters. Propane has been used by CF Systems to treat sludges (14). Pentane, hexane and mixtures of the two have been used to clean offshore oily cuttings (36). For the C3 and C4 solvents, the column would have to be operated slightly above the vapor pressure of the solvents to avoid vaporization. Preliminary studies on waste water streams (6) and sludges (54) using pentane and hexane show that significant reductions in toxicity of the wastes are achieved. These studies also indicated that there is a negligible difference in the solvating properties between pentane and hexane for refinery wastes. Pentane was used as the solvent based on the following additional considerations. Pentane has lower boiling point and can be recovered using comparatively less energy, and the cost of pentane is less than that of hexane.

## CHAPTER III

### SCOPE AND OBJECTIVES

The scope of this work was to evaluate the RPC in extracting the organic contaminants present in desalter water. Benzene is one of the primary contaminants present in desalter water and is currently regulated by several pollution control laws (8,12). Hence the performance of the RPC was evaluated in treating a synthetic waste water containing benzene. This was done as there was no equilibrium data on desalter water and hence the performance of the extraction column could not be evaluated in terms of theoretical stages. Evaluation of the column in terms of theoretical stages would aid in identifying the optimum operating conditions for efficient and economic extraction.

Equilibrium data for the desalter water could not be obtained due to the limitations in the analytical capabilities available for this work. Equilibrium data for the ternary pentane-benzene-water system was not available in the literature. Hence equilibrium data had to be generated for the ternary system.

One of the limiting factors in the application of solvent extraction is the costs associated with solvent losses and recovery. This significant

contribution to the cost of the extraction process can be reduced by employing higher water to solvent ratios. The limiting factor in this case is the poor stage efficiency when using high water to solvent flow rates. The commonly used water to solvent ratio ranges from 5-10 (11). The main advantage of the RPC is the efficiency of contacting the two phases by providing uniform agitation over the column height which results in large interfacial area between the two phases. With these advantages, the RPC is reported to attain very high extraction efficiencies as compared to other industrial extractors (18,51). A 1 inch diameter reciprocating plate column was constructed as described by Karr (33). The efficiency of the extraction column was determined at water to solvent ratios of around 30 and compared with the performance at lower water to solvent ratios. The effect of the combined flow rates and the choice of dispersed phase were also evaluated. The choice of dispersed phase would be important due to the wide range of water to solvent ratios to be studied.

The objectives of this work are as follows

i) construct a bench scale reciprocating plate column of 1 inch diameter, and test the performance of the column using the acetic acid-water-methyl isobutyl ketone system. Performance data for this system are available for the 1 inch reciprocating plate column (33).

ii) generate ternary equilibrium data for the pentane-benzene-water system. These data would be used to evaluate the performance of the reciprocating plate column in treating a synthetic waste water containing benzene.

iii) study the extractor performance in treating synthetic waste water containing benzene. The extractor performance would be evaluated

to study the effect of various operating conditions such as solvent ratio, flow rate and choice of dispersed phase.

iv) to perform preliminary extraction of desalter water using pentane and to study the effect of changes in operating variables on the extractor performance in terms of overall organics removal.

CHAPTER IV  
EXPERIMENTAL SETUP AND ANALYTICAL  
TECHNIQUES

Experimental Setup

To carry out the extraction, a laboratory scale reciprocating plate column was constructed as described by Karr and Lo (20). The column, shown in Figure 1, consisted of a Pyrex glass section and two stainless steel bonnets. Agitation was provided by Teflon plates which were mounted on a stainless steel shaft and reciprocated by a motor through an adjustable drive arm.

The column was constructed of a 4 foot section of 1 inch ID Pyrex pipe with conical ends (Model no. 237530). The top stainless steel bonnet had two 1/4 inch nipples for the inlet of the aqueous phase and the outlet of the solvent. The aqueous phase was fed through a 1/8 inch ID stainless steel tube which extended about 10 inches into the top of the column. The bottom stainless steel bonnet had one 1/4 inch nipple which was connected to a heat exchanger tee assembly. The solvent was introduced through an 1/8 inch ID stainless steel which tube passed through the nipple and extended about 10 inches into the bottom of the column. The aqueous

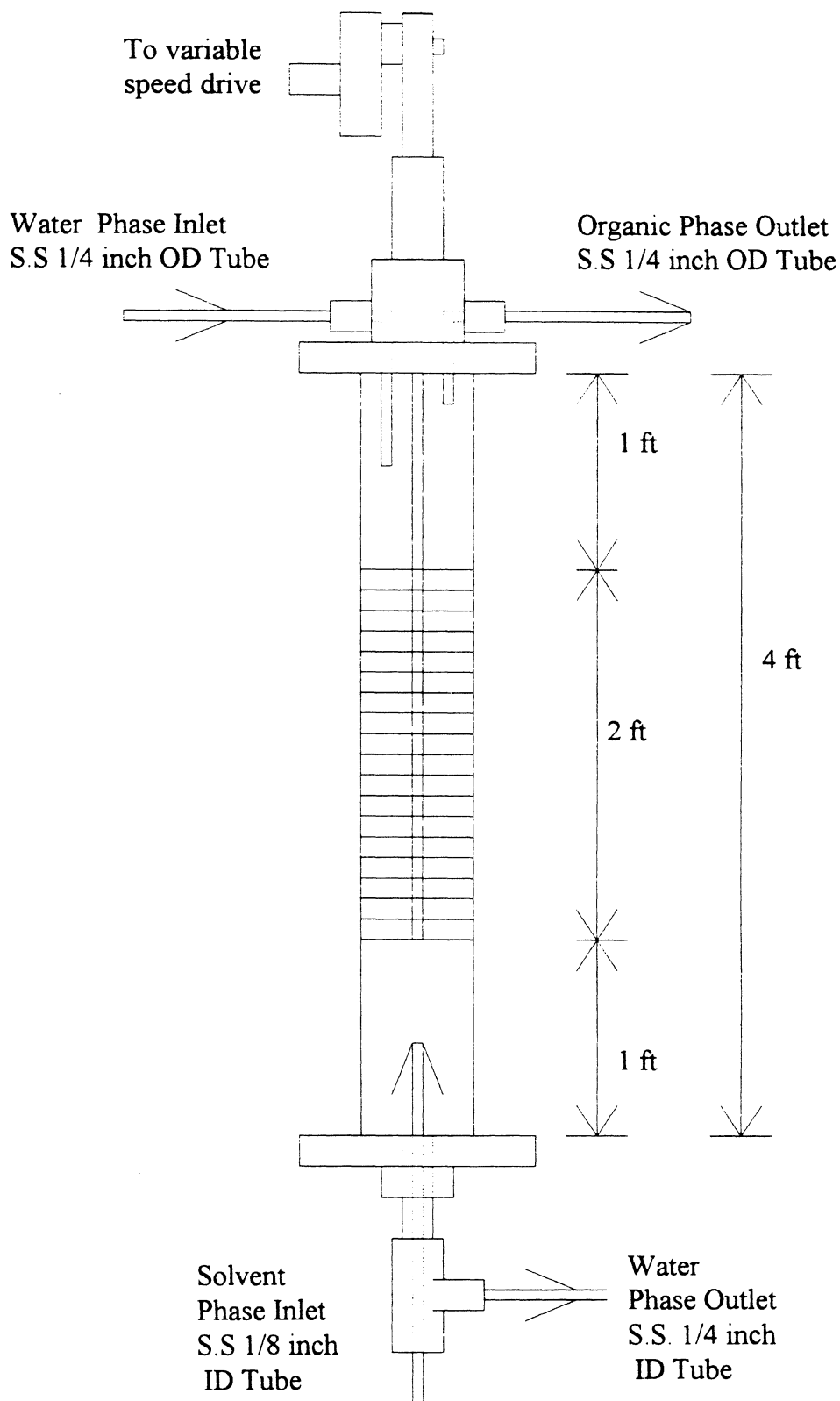

Figure 1. Reciprocating Plate Column Details

phase was drained through a 1/4 inch OD stainless steel tube, connected to the tee as indicated in Figure 1.

The plates were made of 1/16 inch thick Teflon sheet. Holes were cut in the plate as shown in Figure 2, resulting in a free area of about 50%. These 1 inch diameter plates were mounted on a 1/8 inch diameter stainless steel shaft. The length of the 1/4 inch OD spacers between the plates determined the plate spacing. With a 1 inch plate spacing the plates occupied the central 2 feet of the column. One foot of phase disengaging space was provided at both the top and the bottom of the column.

Reciprocation was provided by a 60 watt variable speed motor (Gerald K. Heller, Model no. GT 21) through an adjustable cam drive. The speed of the motor could be varied from 0-600 rpm and the stroke length (2 times the amplitude) could be adjusted from 0-4 inches. The motor speed was measured by a tachometer (Cole Parmer, Model no. 08212) fitted with a remote optical sensor (Monarch Instruments, Model no. RS 04) to within  $\pm 1$  rpm.

The aqueous stream was fed to the top of the column and the solvent was introduced at the bottom via magnetically driven gear pumps (Micro Pump, Model no. 1840-00) through calibrated rotameters as shown in Figure 3. The flows could be varied from 0-380 ml/min for the water stream and 0-60 ml/min for the solvent stream. The rotameters were calibrated by measuring the volume of liquid collected over a period of time. Due to the high relative volatility of pentane, this method resulted in a large percentage of error for the calibration of pentane flow rate. Hence the pentane flow rate was measured by volumetrically displacing water. The flow rates obtained by this method was consistent with a smaller

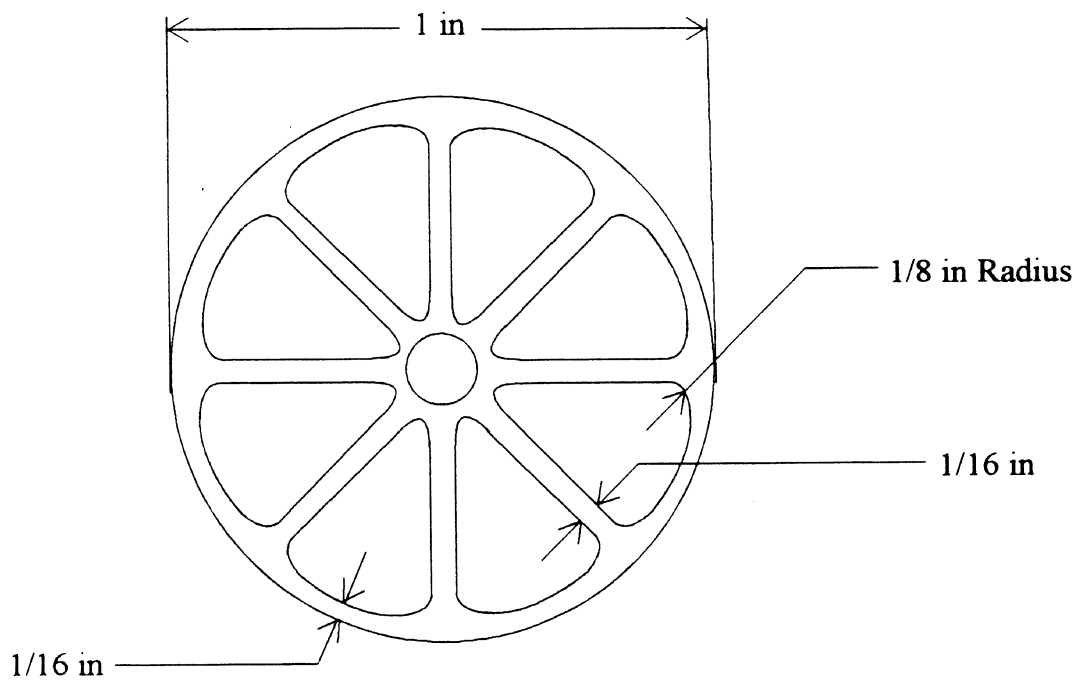

Figure 2. Perforated Plate



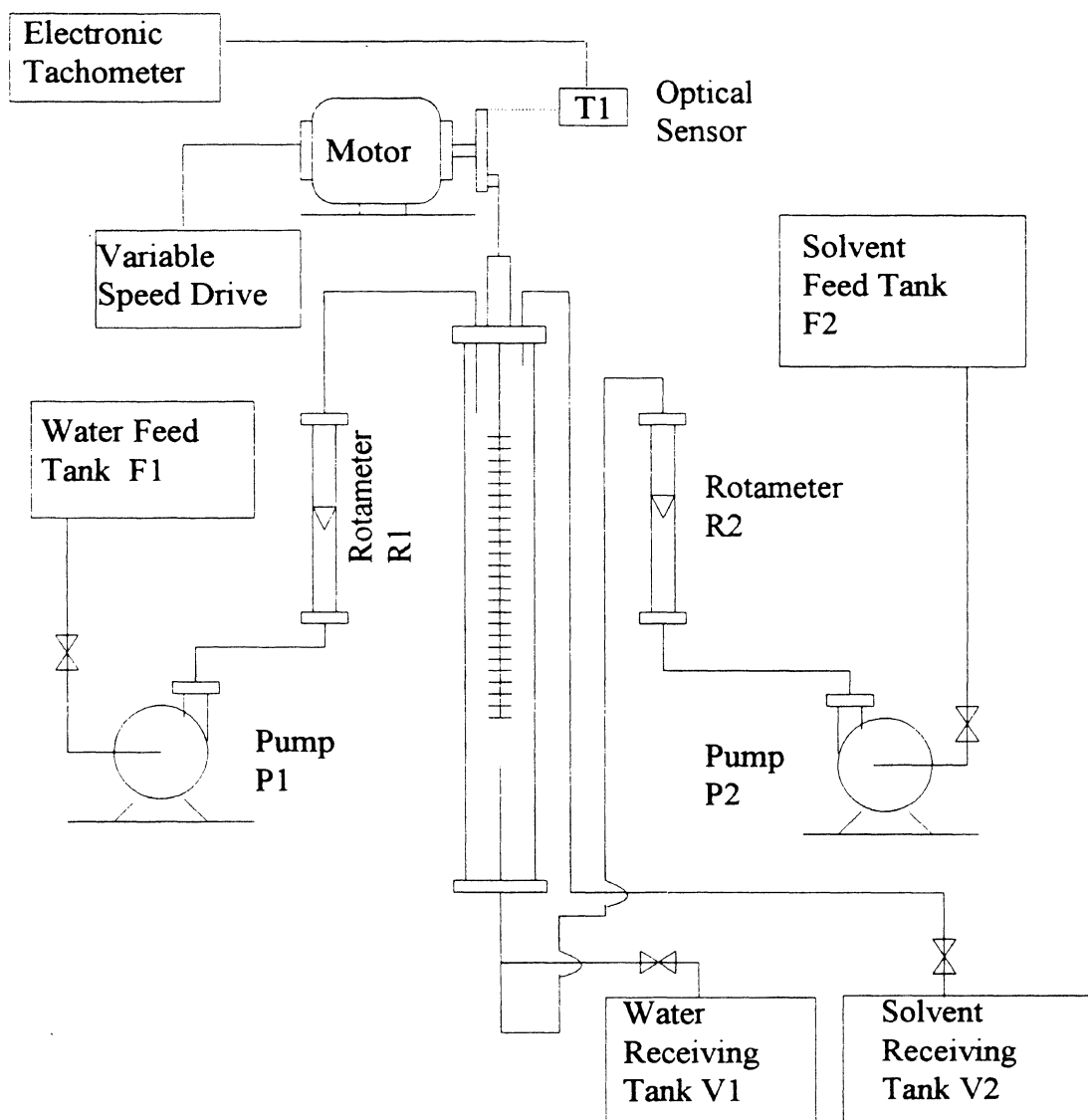

Figure 3. Flowsheet of Extraction Apparatus

percentage of error as shown in Figure 5. The calibration curves are shown in Figures 4 and 5. The waste water was fed from a 2 gallon container and the solvent from a 1 gallon container. The feed reservoirs were elevated to provide flooded suction for the pumps. All materials used were 316 stainless steel and Teflon to prevent contamination of pure component model systems and to minimize corrosion from industrial waste waters.

### Analytical Techniques

The RPC was used to determine the efficiency of pentane in extracting benzene from water and in removing hydrocarbons from desalter water. Equilibrium data were obtained for the ternary system pentane-water-benzene. The analytical procedure used for the ternary equilibrium data and for the extraction of benzene from water was different from that followed for the waste water streams. The difference in procedures is due to the different compounds analyzed. Extreme care had to be exercised in collecting the samples as a result of the low solubilities of hydrocarbons in water. The analytical setup required that the samples be concentrated before GC analysis.

### Cleaning Procedure

Cleanliness of the sample bottles used was crucial due to the low concentrations of the solutes analyzed. The bottles were first soaked in benzene and dried in an oven for an hour at 100°C. They were then soaked in tap water for 24 hours and then rinsed with distilled water. The bottles

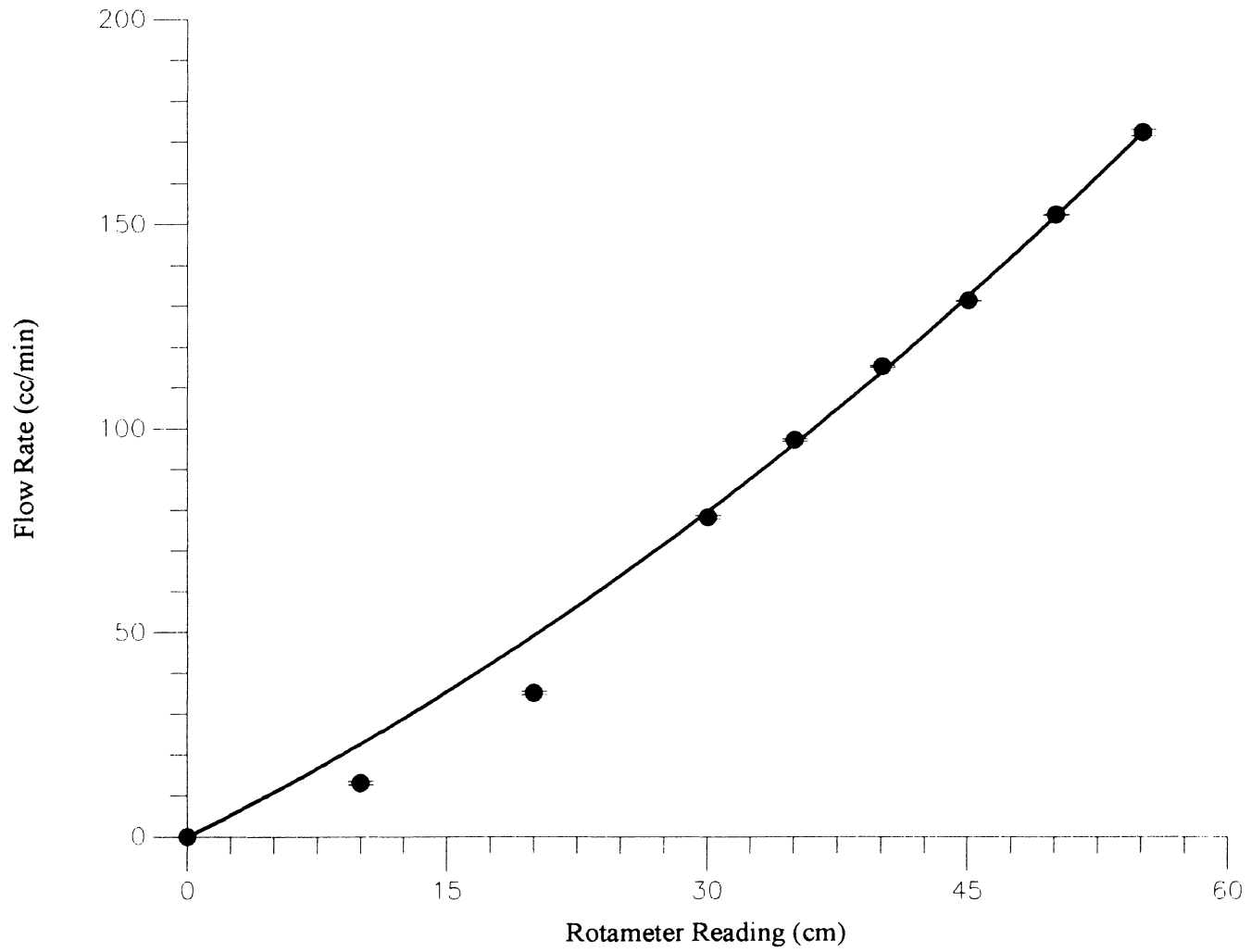

Figure 4. Calibration Curve of Rotameter (R1) for Water Flow Rate

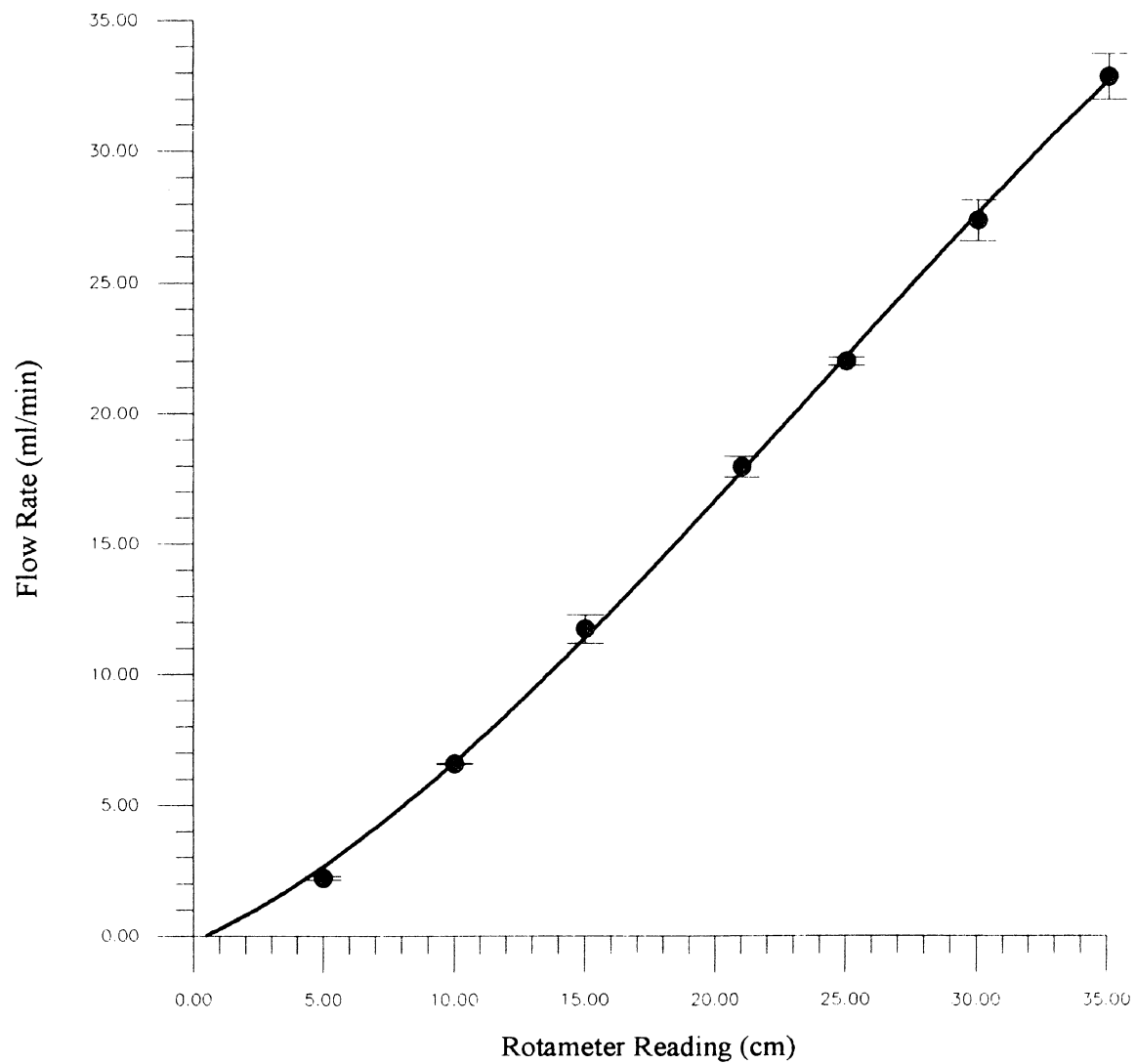

Figure 5. Calibration Curve of Rotameter (R2) for Pentane Flow Rate

were then dried in an oven for 8 hours at 240°C at the end of which they were capped and stored.

### Sample Concentration

The aqueous phase samples of the benzene-water-pentane system and the waste water streams had to be preconcentrated before analysis. The concentration steps for the aqueous phase samples are given below. The organic phase samples could be analyzed directly.

Ternary System The aqueous sample was concentrated using ethylbenzene. Ethylbenzene was selected because it resulted in good peak separation in the GC analysis. About 4 ml of ethylbenzene was weighed accurately to 1 mg in a 120 ml amber colored bottle. The bottle had an open cap with a Teflon lined silicon septum. Approximately 110 ml of the aqueous phase sample was collected in this bottle and weighed. The bottle was shaken vigorously in order to transfer the solutes to the organic phase. It was then allowed to stand for 4 hours before the GC analysis.

Waste Water Streams The waste water streams were concentrated by a method similar to an EPA method for preparing ground water samples to analyze trace components (EPA Method 525). In this sample preparation method, 1 liter of aqueous phase was required. This sample was passed through a reverse phase extraction column ( J. T. Baker, Model No. 7020-07) under a vacuum of approximately 11 mm Hg. The column was conditioned initially with 20 ml of methanol, 20 ml of methylene chloride, and 10 ml of distilled water. Before the column became dry, the sample was allowed to wet the column. The vacuum was maintained at 11 mm Hg,

as higher values resulted in poor retention of the solutes. The sample took about 2 hours to pass through the cartridge. The column was then eluted with about 10 ml of methylene chloride, which was finally concentrated to about 1 ml prior to GC analysis. The sample was accurately weighed to 1 mg prior to analysis.

### GC Analysis

The analysis of the samples for the ternary system and the waste water streams were carried out as follows.

Ternary System The sampling and analysis technique as described by Chen (6) was followed. The GC used for the analysis of the ternary system was a Hewlett Packard (Model HP 5880A) equipped with a thermal conductivity detector. The column was a 6 feet x 1/8 inch column packed with Alltech Super Q. Operating conditions for the chromatograph are summarized in Table 1.

As described in the sampling procedure, ethylbenzene was used to preconcentrate the aqueous phase samples. It was also used as the internal standard in analyzing for pentane and benzene in both the aqueous and organic phases. The samples were accurately weighed to 1 mg and around 100  $\mu$ l of the internal standard was added to the sample. The sample was weighed again and the difference in weights gave the amount of internal standard added. Calibration curves were prepared for ethylbenzene-pentane and ethylbenzene-benzene over the concentration range expected. The curves, shown in Figures 6 and 7, were linear over the area of interest. The GC was checked daily for any changes in detector response. The agreement

TABLE 1

## SUMMARY OF GC DETAILS AND OPERATING CONDITIONS

	Pure Component Analysis	Waste Water Analysis
GC	HP 5880 A	HP 5890 A
Detector	TCD	TCD
Column	Packed Column 1/8 inch x 6 feet packed with Super Q	Capillary Column 0.53 mm x 30 m with 1.5 $\mu$ m Methyl Silicone substrate
Carrier Gas	Helium	Helium
Injector Temperature	200 $^{\circ}$ C	250 $^{\circ}$ C
Detector Temperature	200 $^{\circ}$ C	250 $^{\circ}$ C
Column Temperature	200 $^{\circ}$ C	Initial Temp = 85 $^{\circ}$ C Initial Time = 2 min Program Rate = 5 $^{\circ}$ C/min Final Value = 130 $^{\circ}$ C Program Rate A = 10 $^{\circ}$ C/min Final Value A = 200 $^{\circ}$ C Program Rate B = 15 $^{\circ}$ C/min Final Value B = 300 $^{\circ}$ C Final Time = 17 min
Gas Flow Rates	Carrier/Reference Flow = 30 ml/min Auxiliary Gas Flow = 40 ml/min	Column Flow Rate = 1 ml/min Make Up Gas Flow = 11ml/min Purge = 3.6 ml/min

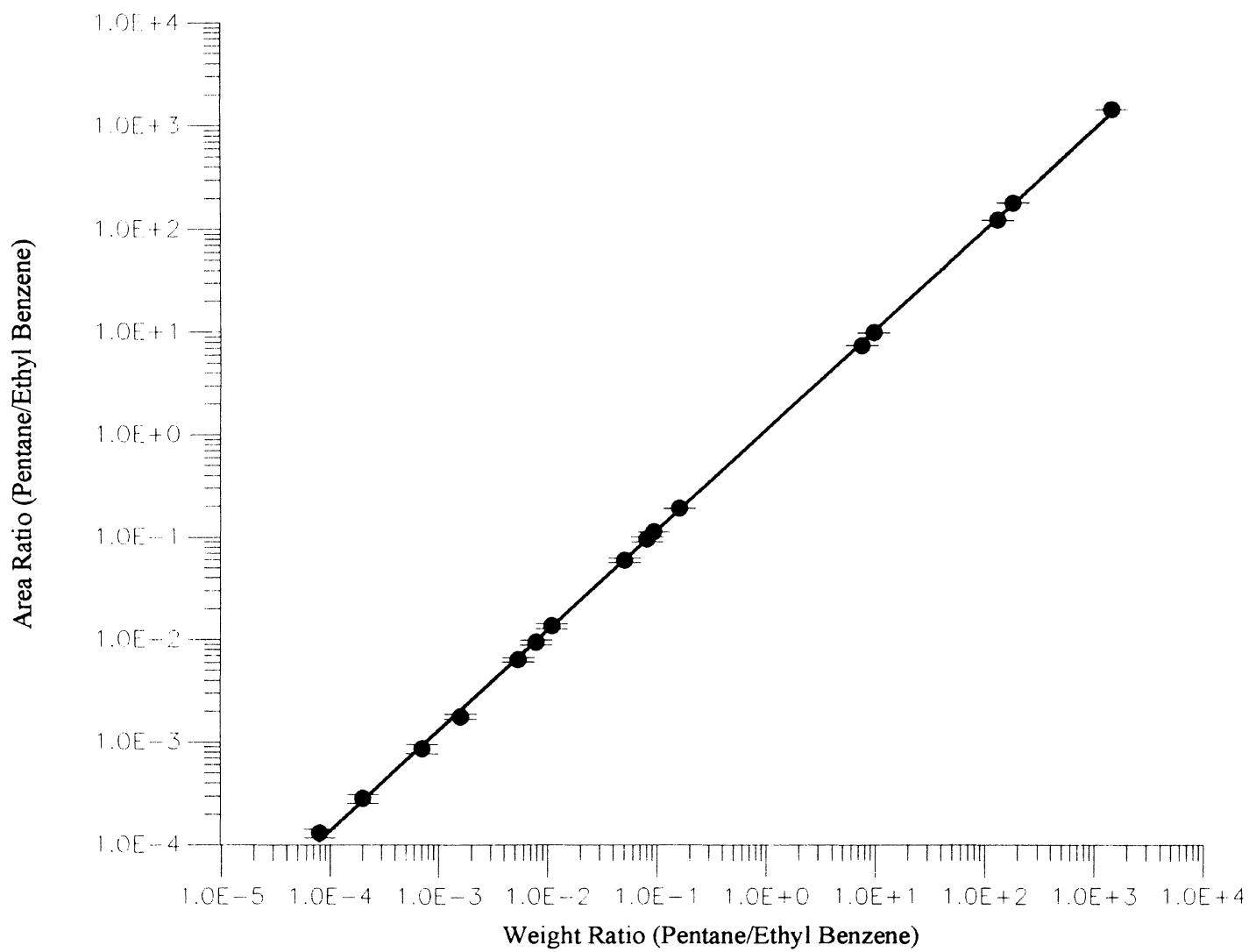

Fig 6. Calibration Curve for GC Analysis for Pentane - Ethyl Benzene



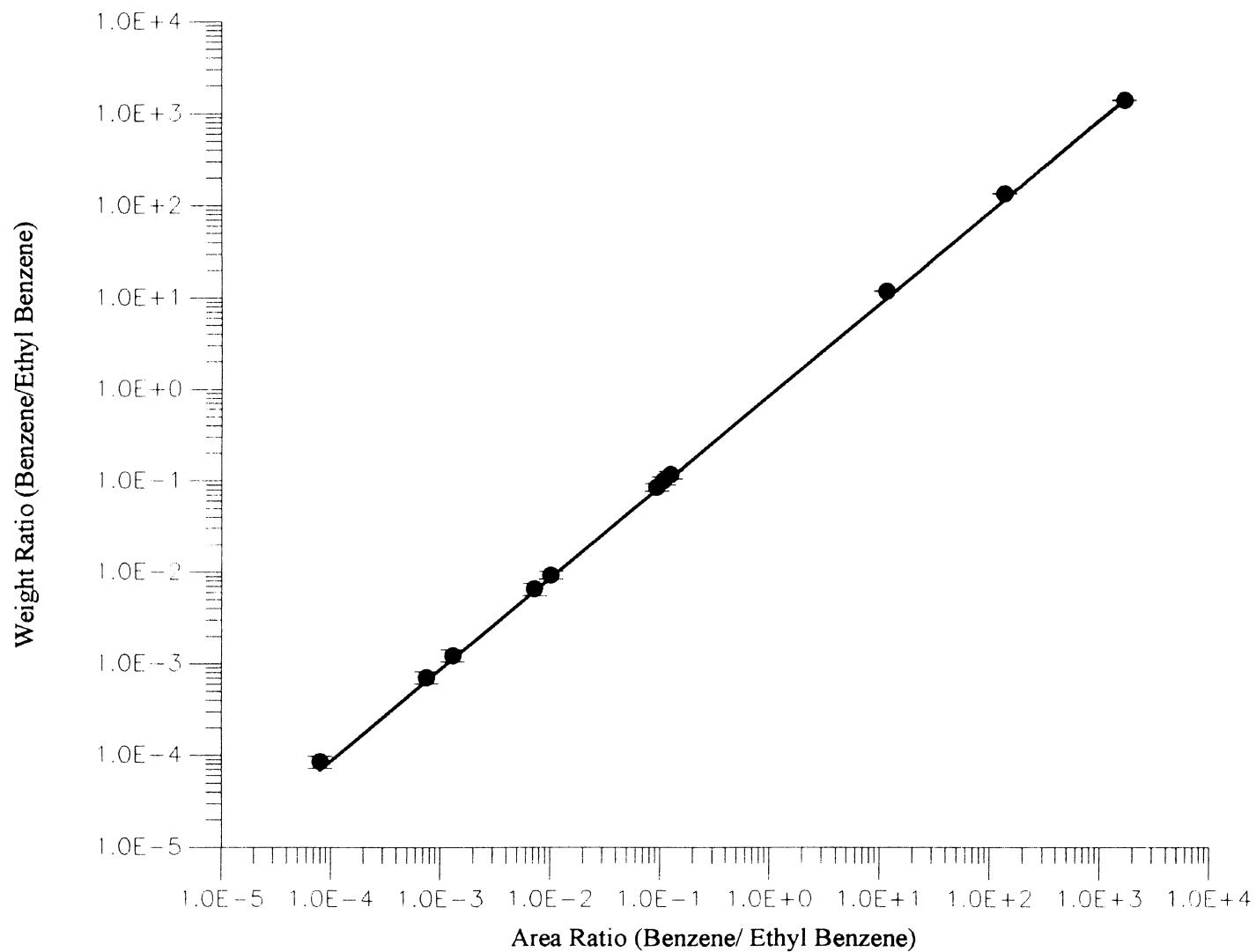

Fig 7. Calibration Curve for GC Analysis for Benzene - Ethyl Benzene

with the calibration curve should be within 1%. Larger deviations resulted in the preparation of new standards and new calibration curves.

Waste Water Streams The analysis procedure for the waste water streams utilizes a Hewlett Packard gas chromatograph (Model HP 5890A) as described by Wilson (54). The GC is equipped with a HP 3392A integrator and a thermal conductivity detector (TCD). The column was a J&W 30m x 0.53 mm DB1 Durabond capillary column with a 1.5  $\mu\text{m}$  methyl silicone substrate. Operating conditions are summarized in Table 1. In this method, toluene served as the internal standard. The calibration curve for methylene chloride-toluene is shown in Figure 8. The aqueous phase was analyzed for the total peak area of organics.

### Chemicals

Glacial acetic acid was used. Methyl isobutyl ketone, pentane, benzene, methanol and methylene chloride used were of spectral grade purity. Ethylbenzene of 99% purity and toluene of 99.8% purity were used. The waste water used was process waste water from a crude desalting unit.

### Equilibrium Data

The equilibrium data for the ternary pentane-water-benzene system was obtained as follows. Solutions of known compositions were prepared gravimetrically by mixing water, benzene and pentane in different proportions in 500 ml bottles. These bottles were shaken vigorously to

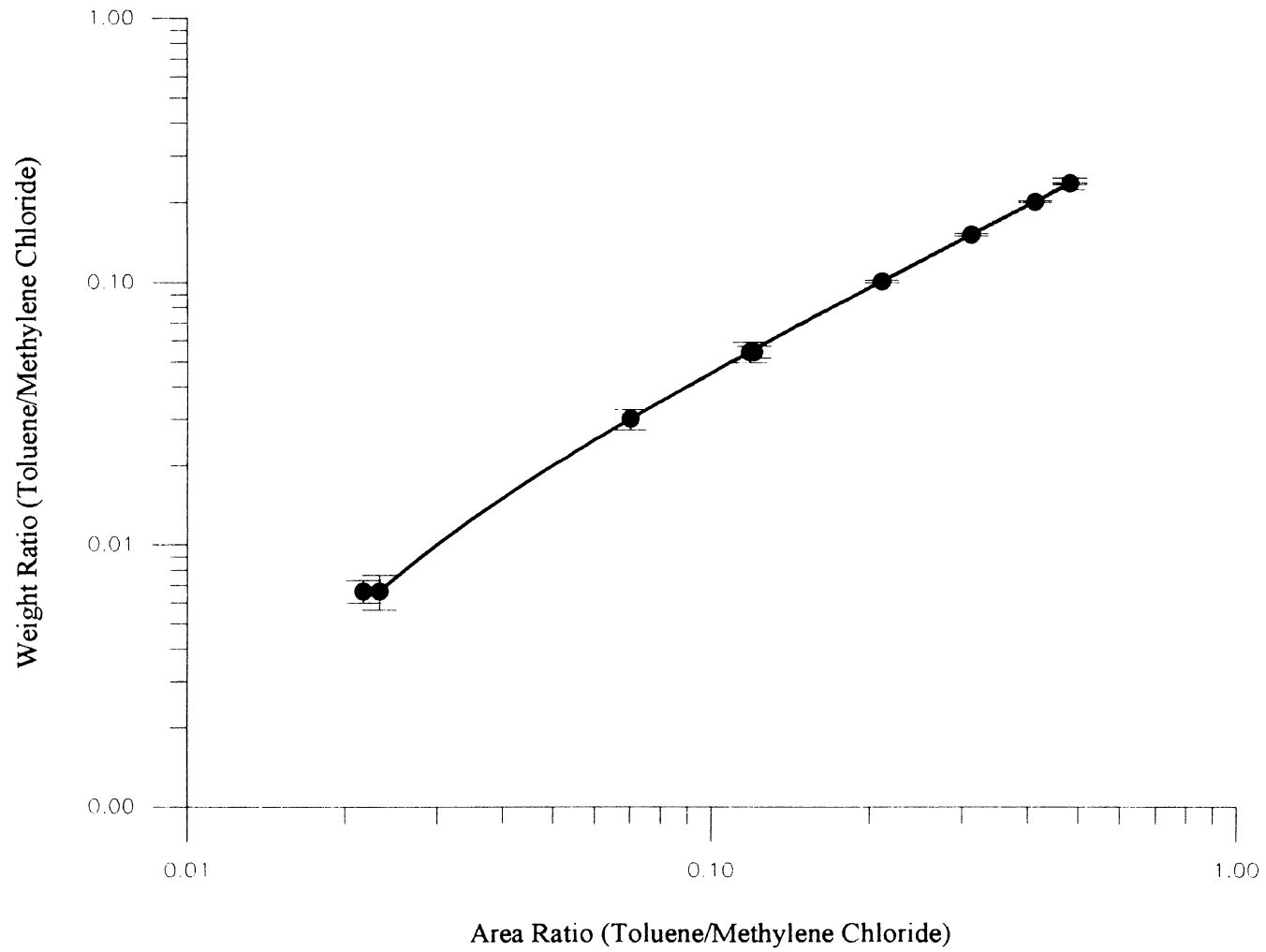

Figure 8. Calibration Curve for GC Analysis for Methylene Chloride - Toluene

ensure adequate mixing and the solutions were then transferred to a separatory funnel. In the funnel, each solution was allowed to stand overnight to ensure complete separation of the two phases. The temperature was not regulated and the room temperature was  $24 \pm 2$  °C. Samples were obtained from the organic phase and the aqueous phase. The organic phase sample was analyzed directly after the addition of internal standard. The water phase sample was pre-concentrated using ethylbenzene, which also served as the internal standard, prior to analysis.

## Operating Procedure

### Synthetic Waste Water

The synthetic waste water to be treated in the RPC was prepared by mixing benzene vigorously with water. The solution was then left to stand for 2 hours with a layer of benzene on the top. This method resulted in the concentration of benzene varying between 0.14% to 0.17% by weight. This variation in the concentration of benzene was a result of inadequate time for equilibration for the two phases. The duration of one run was around  $1\frac{1}{2}$  hours. To ensure that the feed concentration of benzene did not vary for the duration of the run, the feed solution was sampled three times: at the start of the run, near the midpoint, and at the end of the run. The change in benzene concentration was within the range of experimental error and hence the change in feed composition was assumed to be negligible for the duration of the run. Pure pentane was used as the solvent.

The operating procedure for the RPC was as follows. The column was filled with the continuous phase and the desired flow rate was set. The

dispersed phase was then pumped through the column and the interface was established about 6 inches from the end of the column. The flow rate of the dispersed phase was also set at the desired value. Agitation was started and slowly increased until the onset of flooding. Flooding occurred when the dispersed phase formed an emulsion layer. This emulsion layer tended to increase until the frequency of reciprocation was reduced. The speed was reduced, and the column was then operated at about 90% of the flooding speed. Steady state was achieved by the time the contents of the column had been replaced three times by the combined flows of the two streams. The raffinate and the extract streams were then sampled.

#### Waste Water Treatment

Crude desalter water was used as the feed. A thin layer of oil could be noticed on the desalter water. This oil emulsified upon slight disturbances. The desalter water fed to the column was decanted and care was taken to ensure that the water did not contain emulsified oil. Pentane was used as the solvent. The operating procedure is the same as described for the ternary system.

## CHAPTER V

### RESULTS AND DISCUSSION

#### Equilibrium Data

This ternary system had not been previously studied in the literature. The solubilities of benzene and pentane in water were measured and were found to be  $1710 \pm 80$  ppm and  $41 \pm 5$  ppm respectively. The solubility of benzene in water at 298°K has been reported by several workers (18). The measured solubility of benzene in water agrees with the data of Morrison ( $1716 \pm 10$  ppm, 37) and Corby (1700 ppm, 10). The new data was found to be lower than the data reported by several other workers as McAuliffe ( $1780 \pm 45$  ppm, 35), Chen ( $1820 \pm 96$  ppm, 6), Alexander ( $1800 \pm 15$  ppm, 2) and Leinonen ( $1765 \pm 30$  ppm, 30).

The measured solubility of pentane in water agrees well with the data of Nelson ( $40.5 \pm 6.8$  ppm, 38), Price ( $39.5 \pm 0.6$  ppm, 41) and Jonsson ( $40.6 \pm 2$  ppm, 19). The data of Barone ( $49.7 \pm 2$  ppm, 5) and Polak ( $47.6 \pm 1$  ppm, 40) are higher than the new data while that of McAuliffe ( $38.5 \pm 2$  ppm, 35) is slightly lower.

The distribution data for benzene between pentane and water is tabulated in Appendix B. The distribution curve for benzene between

pentane and water was found to be linear as shown in Figure 9. The distribution coefficient,  $K_d$ , for benzene was found to be 594.8 on a weight basis.

### Extractor Performance

The extractor performance was evaluated in terms of the HETS (Height Equivalent to a Theoretical Stage). The HETS was obtained by

$$\text{HETS} = \frac{H}{\text{NTU}_{\text{ow}}} \quad (1)$$

where  $H$  = height of the contactor, and  $\text{NTU}_{\text{ow}}$  = overall number of transfer units based on the water phase.

The  $\text{NTU}_{\text{ow}}$  was obtained (52) from the experimental concentrations as

$$\text{NTU}_{\text{ow}} = \frac{E}{E-1} \ln \left( \frac{E-1}{\eta E} + \frac{1}{E} \right) \quad (2)$$

where  $E$  is the extraction factor and is given by

$$E = \frac{K_d F_s}{F_w} \quad (3)$$

where  $K_d$  is the distribution coefficient and  $F_s$  and  $F_w$  the flow rates of the solvent and the feed. The distribution coefficient is assumed to be constant over the range of concentration used. The second variable  $\eta$  in Equation 2 is defined as

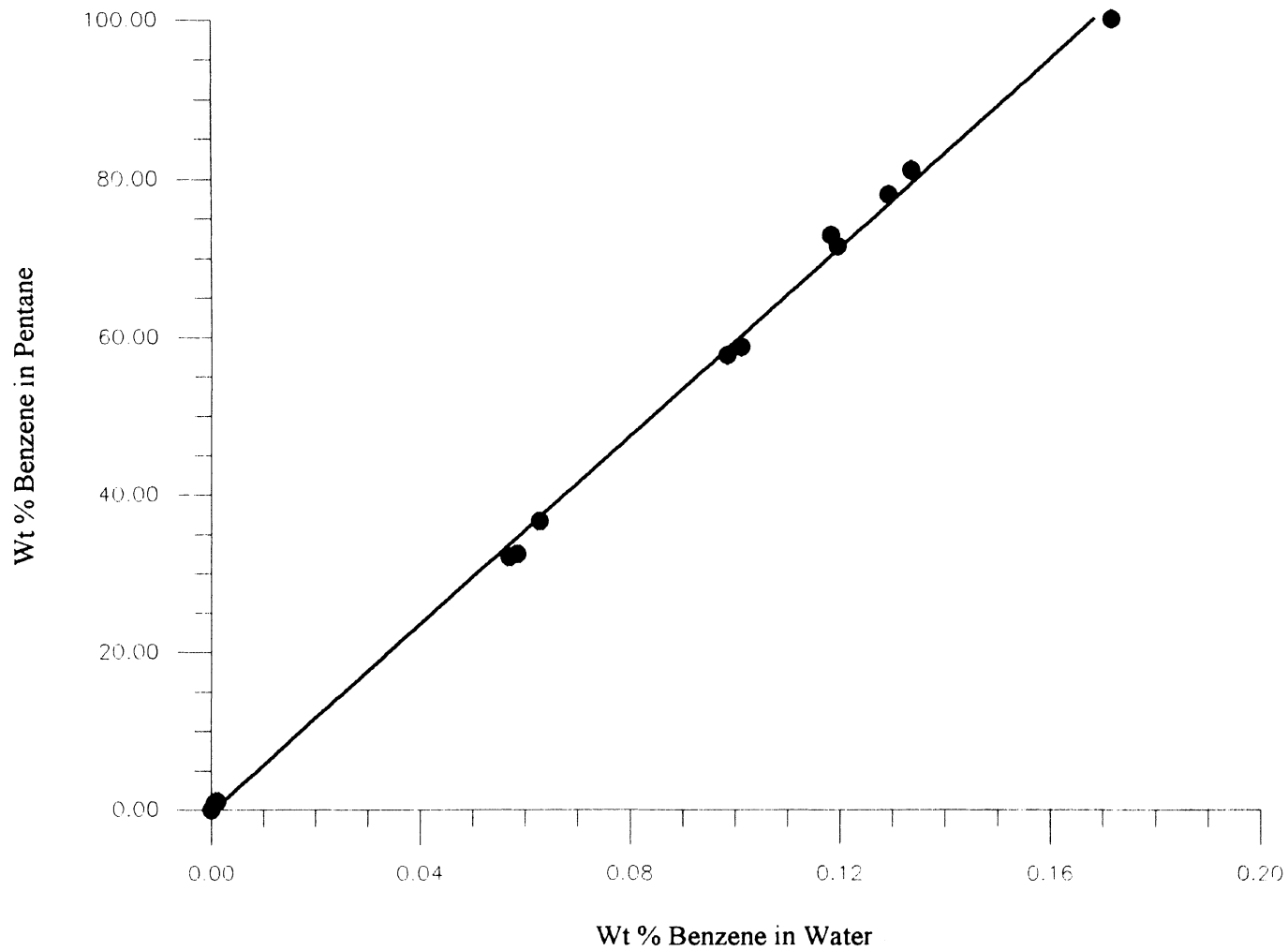

Figure 9. Distribution Curve for Benzene between Pentane and Water



$$\eta = \frac{x_{w_i} - x_{s_i}/K_d}{x_{w_o} - x_{s_i}/K_d} \quad (4)$$

where  $x_{w_i}$  is the weight fraction of solute in the product,  $x_{w_o}$  is the weight fraction of solute in the feed, and  $x_{s_i}$  is the weight fraction of solute in the solvent feed. For a pure solvent,  $x_{s_i}=0$  and the above equation reduces to

$$\eta = \frac{x_{w_i}}{x_{w_o}}$$

Overall stage efficiencies were calculated as follows

$$\text{Plate Efficiency} = \frac{\text{Number of ideal stages}}{\text{Number of actual stages}} * 100 \quad (5)$$

where the  $NTU_{ow}$  is taken as the number of ideal stages, and the number of actual stages depends on the height of the plate stack.

In addition, the percentage reduction of solute was calculated as

$$\text{Percentage Reduction} = \frac{x_{w_o} - x_{w_i}}{x_{w_o}} * 100 \quad (6)$$

### Column Evaluation

The performance of the reciprocating plate column was tested using the system acetic acid-MIBK-water. This system was selected as performance data on this system was available for a 1 inch reciprocating plate column (33). The equilibrium data of Karr(20) were used and are given in Appendix B. Acetic acid was extracted from the ketone phase to the water phase under the following operating conditions,

Number of plates :25                      Amplitude                      :1/2 inch  
 Plate spacing                      :1 inch                      Agitator Speed                      :240 SPM  
 Flow rate of MIBK :378.2 gal/hrft<sup>2</sup>  
 Flow rate of water : 179.8 gal/hrft<sup>2</sup>

The feed and exit concentrations of acetic acid, in weight percentage, was:

Concentration in solvent : 11.33%

Concentration in extract : 3.56%

Concentration in feed : 2.04%

Concentration in raffinate : 13.98%

The number of theoretical stages was found to be 5.65 by graphical interpolation as shown in Appendix B. This data is in fairly good agreement with Karr's data. Under similar operating conditions, Karr found the number of theoretical stages required to be 5.82.

### Experimental Errors and Error Propagation

The errors in the experimental quantities measured in this work were determined using the standard statistical formula

$$s^2 = \frac{\sum |Y - \bar{Y}|^2}{n - 1}$$

where s is the standard deviation of the sample, n is the number of data points,  $\bar{Y}$  is the average or mean of the data points and Y is the experimental value. A detailed discussion of the error analysis is presented in Appendix A. The experimental data obtained were used to evaluate the

extractor performance in terms of HETS, percentage reduction in benzene, and overall removal of organics present in desalter water. The errors in these quantities were estimated by error propagation, which is discussed in Appendix A. The standard deviation estimated from the error analysis was used to determine if there were any statistically significant differences in the extractor performance for different operating conditions.

### Range of Variables

Previous studies on mass transfer in RPC have shown that for a given set of operating conditions, maximum efficiency is obtained at agitation levels close to that of flooding (20). Hence for this work, the parameters for a particular run were fixed and the agitation was increased to obtain the flooding point. The column was then operated at about 90% of the flooding agitation speed. The runs were carried out at a constant plate spacing of 1 inch and an amplitude of 1/2 inch. To minimize the effect of solute concentration, all the runs were done with a solute concentration of about 0.14% to 0.17% by weight for the ternary system. The extractor performance was studied for the effects of the following variables: combined flow rates, solvent ratios, and the choice of dispersed phase. The ranges of the operating conditions were; combined flow rates from 60 ml/min to 160 ml/min, solvent ratios of 1:1 to about 1:30, and water as both the dispersed and the continuous phase. Flow rates of around 60, 90, and 150 ml/min at each of three solvent ratios (of around 1:5, 1:15 and 1:30) were studied. A full factorial design (3x3x2) resulted in a total of 18 runs

for each system. The results for the ternary system are summarized in Table 2, and the results for desalter water are summarized in Table 3.

### Flow Characteristics

The interfacial tension for the system pentane-water is high (44 dynes/cm) compared to other systems such as kerosene-water (20 dynes/cm), and MIBK-water (8 dynes/cm). When pentane is dispersed, it preferentially wets the plate material. With no agitation, severe channeling of the dispersed phase was observed along the Teflon spacers mounted on the shaft. Only when the agitation intensity ( $A_f$ ) was increased to about 4.3 cm/sec, were small droplets of pentane formed due to the agitating action. The high agitation required to break the drop-to-plate coalescence is due to the high interfacial tension and the preferential wetting of the plates by the organic phase. The agitation could not be increased beyond 6-7 cm/sec, because the column flooded. Even at these agitation intensities, a thin film of pentane could be observed on the Teflon spacers.

With pentane continuous, higher agitation speeds were achieved because the water phase did not wet the plates and solute transfer was out of the droplets. When the agitation was increased, the dispersed phase was broken up into fine droplets which coalesced again due to the Marangoni effect. The Marangoni effect promotes drop-to-drop coalescence when the solute is transferred out of the droplets; drop-to-drop coalescence is inhibited when solute is transferred to the droplets (52). The

TABLE 2

## SUMMARY OF EXTRACTION OF BENZENE FROM WATER WITH PENTANE

RUN	GITATOR SPEED (rpm)	FLOW RATES OF			WT % BENZENE IN				NTU	HETS		PLATE EFFICIENCY (%)	OVERALL $\sigma$ REMOVAL	
		WATER (ml/min)	PENTANE (ml/min)	TOTAL (ml/min)	H2O IN	H2O OUT	C5H1 IN	C5H12 OUT		$\sigma$ <sub>HETS</sub>	EFFICIENCY (%)		EFFICIENCY	EFFICIENCY
WATER CONTINUOUS														
1	343	57.05	1.75	58.80	0.1575	0.0133	0	4.7015	1.07	23.27	0.51	4.30	91.57	0.55
2	345	57.05	2.07	59.11	0.1648	0.0036	0	4.4523	1.66	15.06	0.91	6.64	97.81	0.35
3	340	57.05	2.50	59.55	0.1484	0.0015	0	3.2727	1.99	12.54	1.57	7.98	98.99	0.43
4	341	57.05	3.00	60.05	0.1601	0.0020	0	2.9673	1.90	13.14	1.04	7.61	98.75	0.38
5	250	33.00	30.00	63.00	0.1691	0.0003	0	0.1857	2.78	8.98	2.14	11.13	99.83	0.06
6	345	87.11	3.00	90.12	0.1623	0.0086	0	4.4613	1.28	19.59	0.59	5.10	94.70	0.49
7	320	87.11	6.50	93.61	0.1549	0.0029	0	2.0370	1.72	14.51	0.88	6.89	98.11	0.42
8	355	87.11	7.78	94.89	0.1471	0.0017	0	1.6288	1.94	12.90	1.21	7.75	98.85	0.46
9	297	87.11	21.96	109.07	0.1576	0.0010	0	0.6210	2.18	11.45	1.51	8.73	99.34	0.36
10	298	152.85	5.61	158.46	0.0845	0.0060	0	2.1937	1.15	21.76	0.96	4.60	92.90	1.12
11	274	156.71	8.75	165.46	0.1412	0.0063	0	2.4157	1.35	18.50	0.64	5.41	95.55	0.50
12	274	152.85	8.75	158.75	0.1528	0.0080	0	2.5285	1.28	19.55	0.58	5.12	94.74	0.47
13	280	131.59	33.00	163.00	0.1697	0.0029	0	0.6653	1.77	14.12	0.83	7.08	98.30	0.32
PENTANE CONTINUOUS														
14	250	33.00	10.00	43.00	0.1675	0.0009	0	0.4999	2.28	10.99	1.92	9.10	99.47	0.45
15	340	36.22	30.00	66.22	0.1656	0.0005	0	0.1650	2.49	10.06	2.84	9.94	99.67	0.05
16	335	87.11	2.07	89.18	0.1693	0.0073	0	7.0573	1.37	18.30	1.12	5.46	95.69	0.34
17	390	87.11	7.78	94.89	0.1609	0.0044	0	1.8117	1.57	15.96	1.35	6.27	97.29	0.34
18	282	154.78	5.37	160.15	0.1460	0.0079	0	3.8591	1.27	19.71	0.61	5.07	94.61	0.56
19	283	152.85	7.78	160.62	0.1633	0.0074	0	3.0060	1.34	18.64	1.32	5.36	95.44	0.43

TABLE 3

## SUMMARY OF EXTRACTION RUNS FOR DESALTER WATER WITH PENTANE

RUN	AGITATOR SPEED	FLOW RATES OF			WT % ORGANICS IN		OVERALL REMOVAL EFFICIENCY	$\sigma$ Removal Efficiency
		WATER	PENTANE	TOTAL	FEED	RAFFINATE		
1	255	47	12	59.00	0.1361	0.0075	94.45	3.77
2	223	31	12	43.00	0.1361	0.0268	80.32	10.86
3	224	85	6.5	91.50	0.1361	0.0110	91.88	4.94
4	183	142	4.89	146.89	0.1361	0.0247	81.83	3.86
5	275	59	2.2	61.20	0.7000	0.1475	78.93	2.25
6	258	85	6.3	91.30	0.7000	0.1460	79.15	2.23
7	200	120	33	153.00	0.7000	0.1816	74.05	2.76
8	275	55	4.5	59.50	0.7000	0.1346	80.77	2.06
9	255	70	19.8	89.80	0.7000	0.1186	83.06	1.83
10	200	148	5.3	153.30	0.7000	0.2903	58.53	4.37
11	255	55	4.3	59.30	0.7000	0.0501	92.84	0.87
12	223	88	3.5	91.50	0.7000	0.0996	85.78	1.56
13	273	46	13	59.00	0.1023	0.0155	84.83	3.57
14	254	88	3.3	91.30	0.1023	0.0241	76.43	2.88
15	200	138	11	149.00	0.1023	0.0267	73.91	3.15
16	253	60	2	62.00	0.1023	0.0123	88.01	2.89
17	223	74	17.9	91.90	0.1023	0.0066	93.57	1.75
18	182	139	10	149.00	0.1023	0.0132	87.09	3.08
19	181	128	21	149.00	0.1023	0.0086	91.56	2.15

same factor would inhibit coalescence when pentane is dispersed, keeping it in the form of tiny droplets which leads to flooding.

Desalter water contained various contaminants, and they altered the interfacial tension and the plate wettability characteristics. Much larger drops of pentane were observed with the desalter water than with the synthetic waste water. Lower agitation was required to flood the column compared to the pentane-synthetic waste water system, and hence the interfacial tension is believed to have been reduced. Channeling was observed to be less severe. Desalter water contained suspended solids which did not separate on standing. It was observed that the suspended particles present were completely removed by extraction with pentane.

### Effect of variables

#### Solvent Ratio

When the water-to-solvent ratio was increased, the HETS was found to increase as shown in Figure 10. Error analysis for the HETS is presented in Appendix A. The error in the HETS was found to be large at low water-to-solvent ratios. This is due to the low concentration of benzene in the raffinate. With the water phase continuous, increasing the water-to-solvent ratios increased the HETS at all flow rates. With the pentane phase continuous, there was a marginal increase in the HETS at flow rates of 60 ml/min, 90ml/min and 150 ml/min. Increasing the water-to-solvent ratio decreased the removal efficiency of benzene as shown in Figure 11. The effect of solvent ratio on the removal efficiency had the same trends as the effect of solvent ratio on the HETS. With water phase continuous,

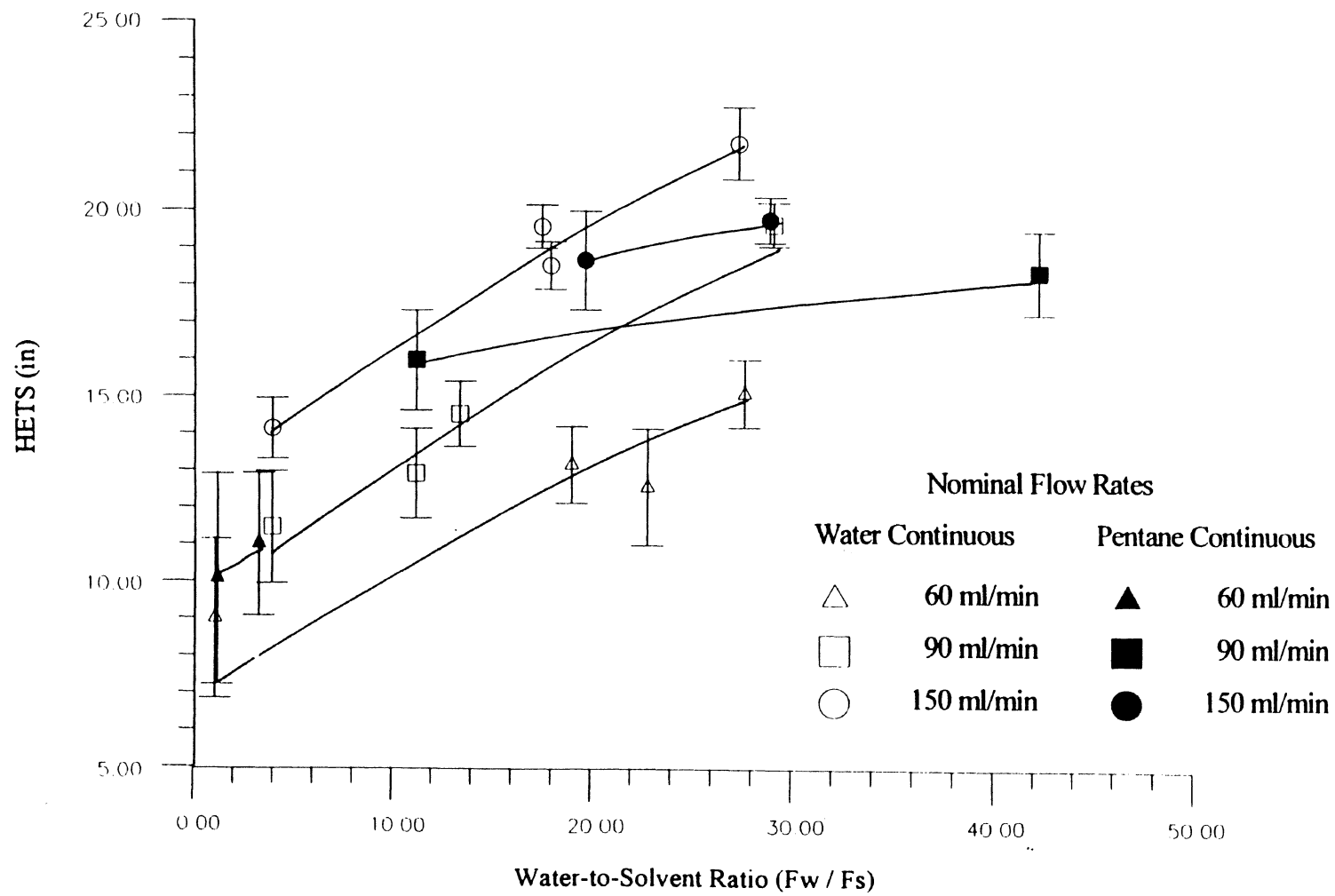

Figure 10. Effect of Solvent Ratio on the HETS



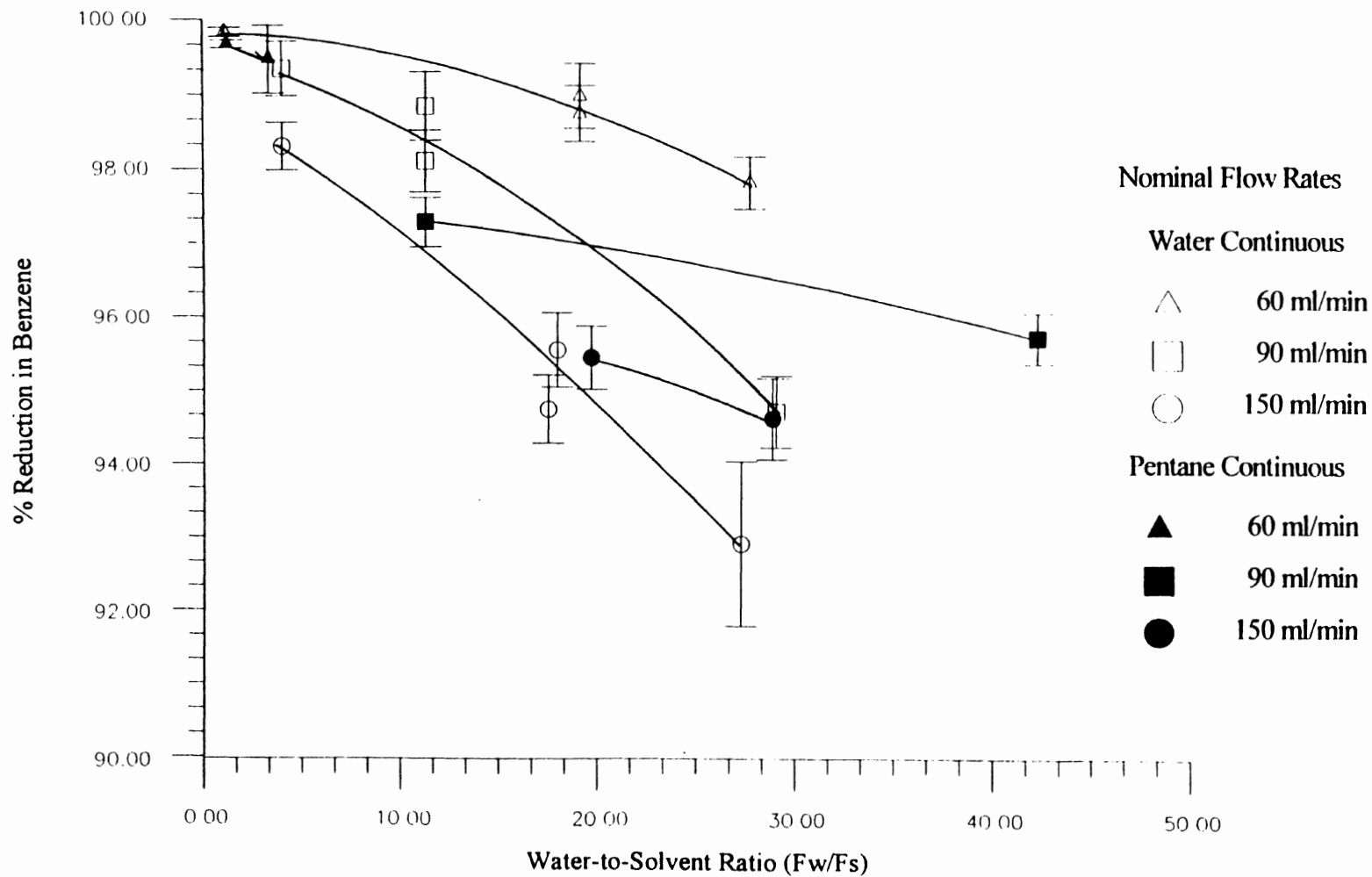

Figure 11. Effect of Solvent Ratio on the Removal Efficiency for Synthetic Waste Water

increasing the water-to-solvent ratio resulted in a sharp decrease in the removal efficiency. With pentane continuous, the decrease in removal efficiency with an increase in water-to-solvent ratio was slight.

With water continuous, at low water-to-solvent ratios, significant drop-to-drop coalescence was observed. Hence the interfacial area available for mass transfer was reduced as a result of large drop diameters. However, the total quantity of solvent passing through was also large. When the water-to-solvent ratio was increased, smaller drop diameters were observed due to lower drop-to-drop coalescence, but the absolute quantity of solvent passing through was smaller. This resulted in the HETS increasing with increasing water-to-solvent ratios. With pentane continuous, there was no significant drop-to-drop coalescence of the synthetic waste water passing through. Hence the effect of water-to-solvent ratio on the HETS and the removal efficiency was only marginal.

For the desalter water, increasing the water-to-solvent ratio resulted in decreasing removal efficiencies with either pentane or water continuous as shown in Figure 12. This is due to the decrease in the interfacial area and is similar to the ternary system.

### Flow Rates

It is found that the HETS increases with increasing flow rates. The variation of HETS with the flow rates is shown in Figure 13. The HETS increases with increase in flow rates at water-to-solvent ratios of 4, 15 and 30, with the water phase continuous. With pentane continuous, a slight increase in the HETS was observed with increase in flow rates.

Flooding in a given column is a function of the agitation intensity which is determined by the reciprocating speed, amplitude and the plate

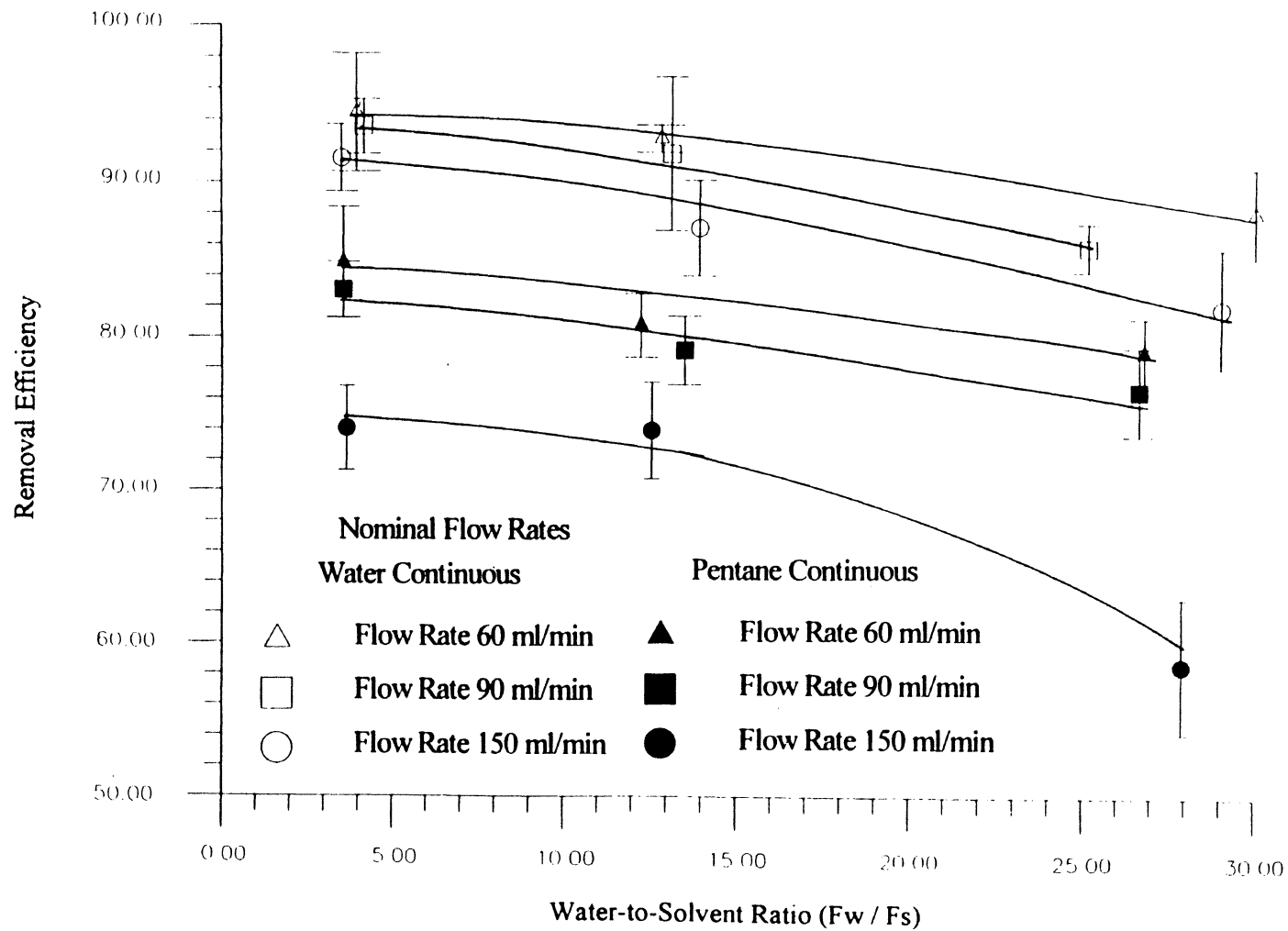

Figure 12. Effect of Solvent Ratio on the Removal Efficiency for Desalter Water

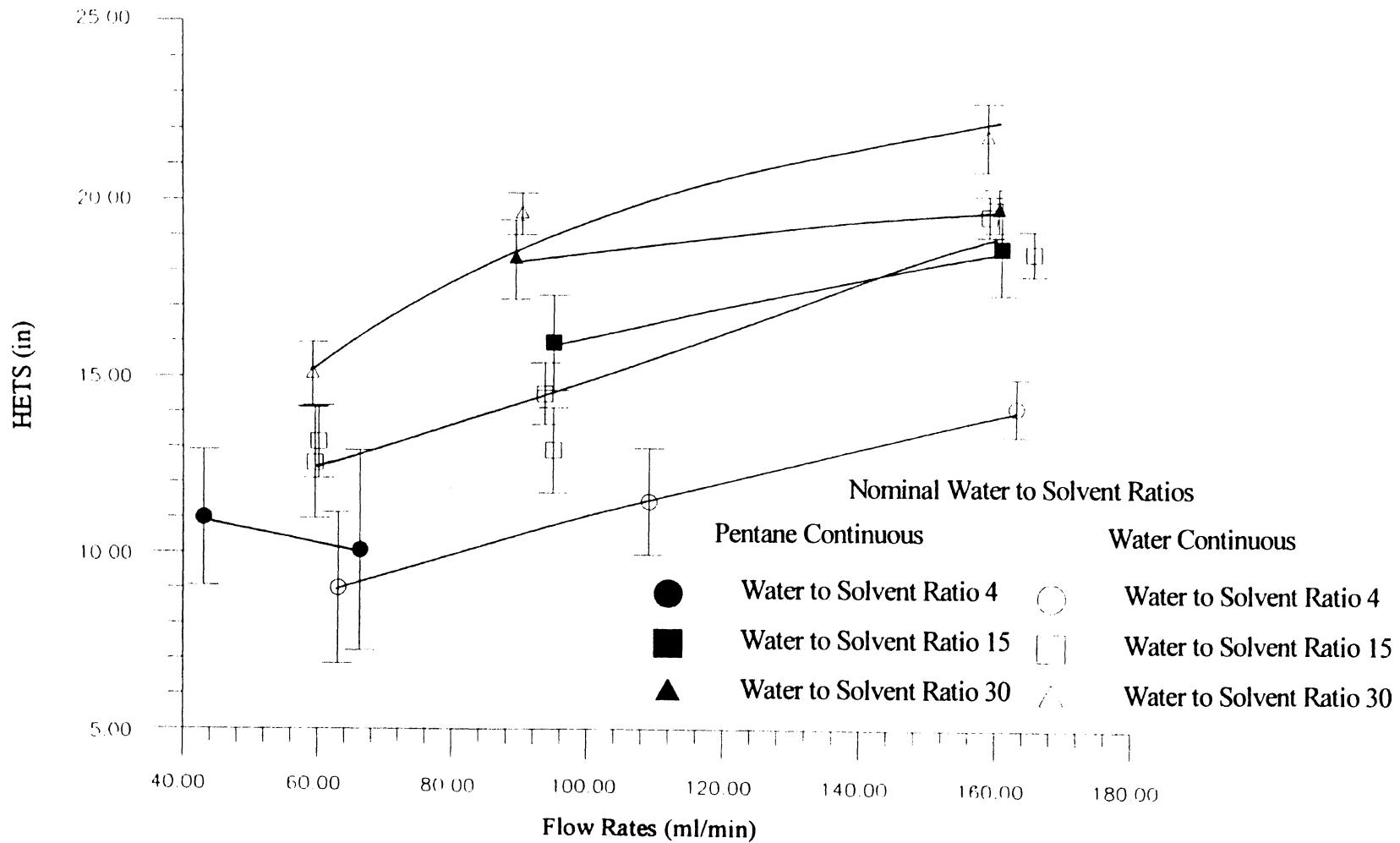

Figure 13. Effect of Flow Rates on the HETS

spacing. For a constant amplitude and plate spacing, the reciprocating speed required to flood the column decreases with increasing throughput (20). As the agitation is increased, the dispersed phase is broken down into small droplets. An increase in the flow rate results in an increase in the slip velocity of the continuous phase. Hence the dispersed phase is more easily entrained in the continuous phase which leads to the onset of flooding.

The number of transfer units ( $NTU_{ox}$ ) is related to the mass transfer coefficient ( $k_{ox}$ ), the interfacial area ( $a$ ), and the superficial velocity ( $U_x$ ) by (49)

$$NTU_{ox} = \frac{HU_x}{k_{ox} a}$$

When the flow rates are increased at a constant solvent ratio, the slip velocity increases. The increase in  $k_{ox} a$  is not large enough to compensate for the increase in  $U_x$ . The percentage reduction in benzene decreases with increasing flow rates as shown in Figure 14. This is due to the decrease in the contact time between the two phases and the decrease in the interfacial area as a result of lower agitation intensity.

For desalter water, increasing the flow rates decreased the removal efficiency as shown in Figure 15. With water continuous, the removal efficiency decreased marginally with increasing flow rates at a water-to-solvent ratio of 5. At water-to-solvent ratios of 15 and 30, an increase in flow rates resulted in a larger decrease in the removal efficiency. With pentane as the continuous phase, the removal efficiency decreases significantly with increasing flow rates at all water-to-solvent ratios.

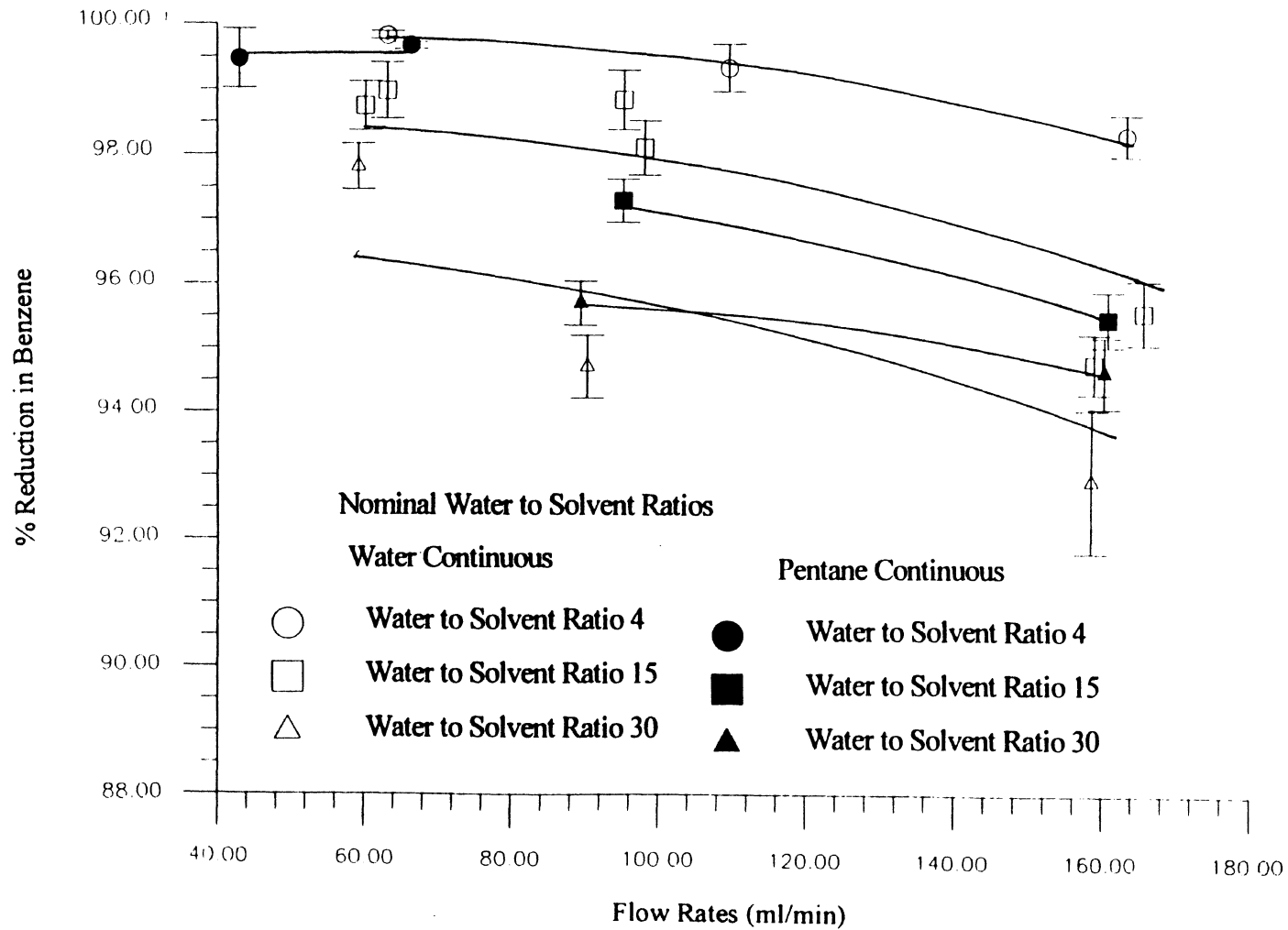

Figure 14. Effect of Flow Rates on the Removal Efficiency

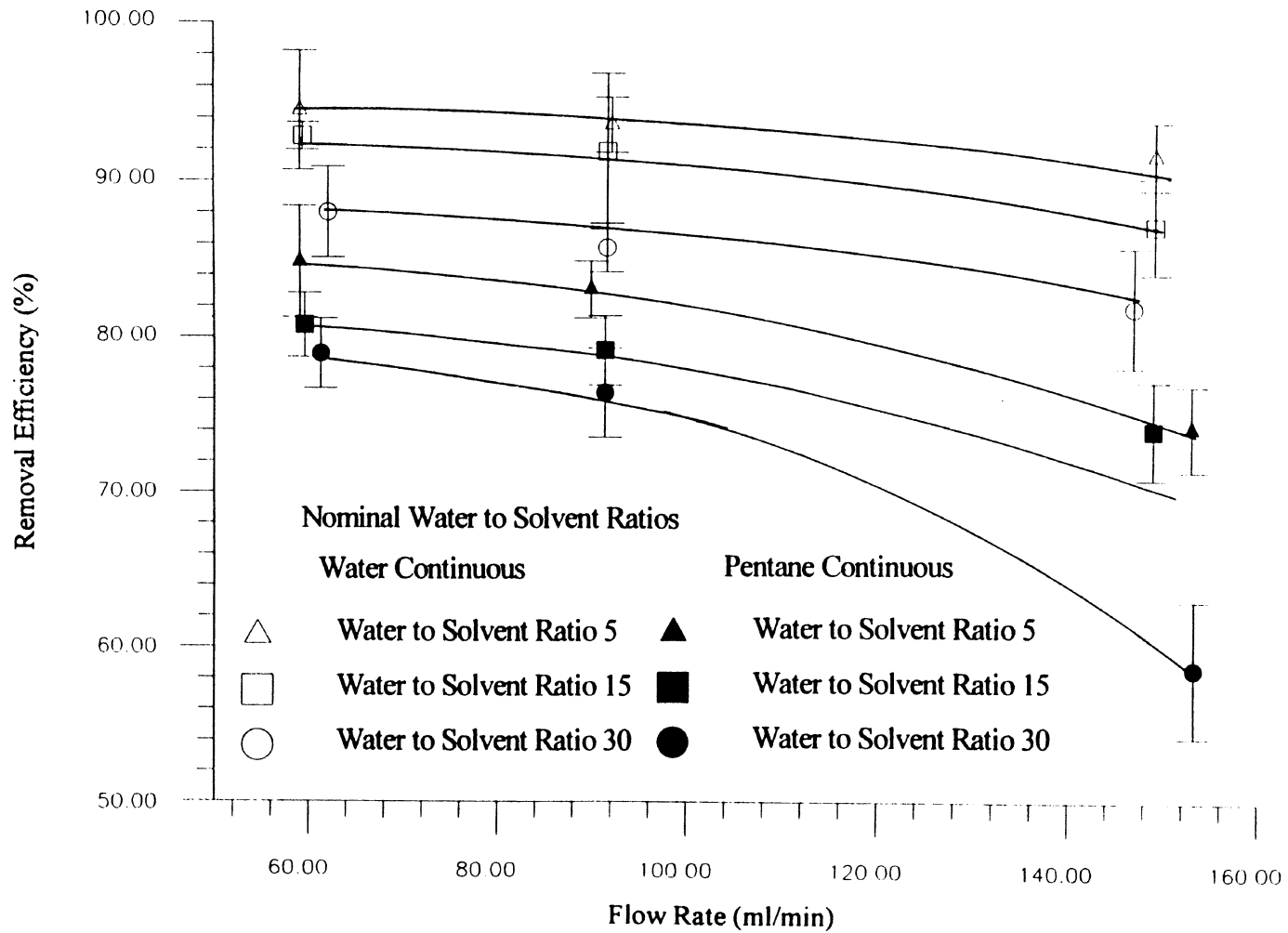

Figure 15. Effect of Flow Rate on the Removal Efficiency for Desalter Water

### Choice of Dispersed Phase

The direction of mass transfer plays an important part in determining the effectiveness of mass transfer. The choice of the dispersed phase is usually dictated by the wettability characteristics of the plate material. It is desirable to choose the continuous phase based on preferential wetting of the plates. When the dispersed phase wets the plate material, drops coalesce and form films on the plates. This drop-to-plate coalescence reduces the interfacial area which results in lower mass transfer and, thus, increases the HETS. Also, the phase giving up the solute should not be dispersed as it induces drop-to-drop coalescence which would result in reduced interfacial area. This reduction in interfacial area has been shown to more than offset the increase in mass transfer coefficient (50).

Based on the above discussion, a minimum HETS would be expected with the organic phase dispersed and a plate material which would be wet by the aqueous phase. In this work Teflon plates were used. The Teflon plates were preferentially wet by the organic phase. Hence higher HETS values were expected with pentane dispersed than when water was dispersed.

At flow rates of around 60 ml/min, the HETS values were higher with pentane continuous as shown in Figure 10. At a flow rate of 90 ml/min, the HETS was lower with water continuous except at a water-to-solvent ratio of 30. At higher flow rates of 150 ml/min, the HETS was higher with water continuous at all water-to-solvent ratios. Similarly, at a water-to-solvent ratio of 4, the HETS was higher with pentane continuous at all flow rates as shown in Figure 13. At a water-to-solvent ratio of 15, the HETS values were lower with water continuous, except at a flow rate of 150 ml/min. At a water-to-solvent ratio of 30, the HETS was higher with water continuous.



A similar trend was observed with the effects of solvent ratio and flow rates on the removal efficiency as seen in Figures 11 and 14. However, for the desalter water, it can be seen from Figures 12 and 15 that the removal efficiency is significantly higher with the water phase continuous than with the pentane phase continuous.

When the dispersed phase wets the plate material, the agitation intensity to cause flooding is increased and the throughput for a given level of agitation could be increased by about 200% before the onset of flooding (49). For the pentane-water system, the direction of mass transfer is from the aqueous phase to the organic phase. Hence the resistance to mass transfer in the organic phase is very low ( due to the equilibrium distribution). When pentane is dispersed, the resistance to mass transfer is inside the droplets and is not significantly affected by the turbulence in the continuous phase. When water is dispersed, the already low resistance to mass transfer in the continuous phase is decreased by mixing. This would result in  $k_c > k_d$ , where  $k_c$  and  $k_d$  are the mass transfer coefficients in the continuous phase and the dispersed phase respectively.

When pentane is dispersed, it preferentially wets the plates resulting in drop-to-plate coalescence. With increased agitation, these drops are sheared from the plate, wherein they are inhibited from coalescing by two factors. One factor is that the solute is transferred into the droplet which retards drop-to-drop coalescence and the other factor is the high interfacial tension which inhibits surface renewal. When water is dispersed, coalescence of the droplets is promoted by the Marangoni effect, due to solute transfer out of the droplets. This was visually observed, with larger droplets formed when water was dispersed than when pentane was

dispersed. This results in  $a_c < a_d$ , where  $a_c$  and  $a_d$  are the interfacial area of the continuous phase and the dispersed phase respectively. Thus

$$k_c > k_d$$

and  $a_c < a_d$ .

It appears that the increase in interfacial area offsets the decrease in mass transfer coefficient resulting in  $k_d a_d > k_c a_c$ . This would be expected as the resistance to mass transfer is already low and would be enhanced negligibly with increased agitation.

When the water-to-solvent ratio was increased from 15 to 30, at a flow rate of 90 ml/min, the HETS obtained was larger with water continuous as shown in Figure 10. The same trend was observed when the flow rate was increased from 90 ml/min to 150 ml/min at a water-to-solvent ratio of 15, as seen in Figure 13. The previous explanation indicates that the interfacial area is the dominant effect in the volumetric mass transfer coefficient. When the solvent to water ratio is decreased with solvent dispersed, the interfacial area available also decreases. However, when water is dispersed, the interfacial area is relatively independent of the solvent ratio. Thus  $a_d < a_c$  as the solvent ratio is decreased. This results in better mass transfer when water is dispersed.

Increasing the flow rates decreases the agitation intensity required to cause flooding. When water is dispersed, increase in flow rates breaks up the droplets, due to impingement on the plates. However, as a result of the Marangoni effect, the droplets coalesce, and hence the flooding agitation is increased. With pentane dispersed, increase in flow rates decreases the agitation intensity due to the onset of flooding. This results in lower interfacial area due to lack of surface renewal.

For the desalter water, the removal efficiency was found to be consistently lower with pentane continuous than with water continuous. This is because the contaminants in the desalter water could have altered the interfacial tension and also the wettability of the plates (22). The increase in interfacial area due to lack of drop-to-plate coalescence offsets the decrease in interfacial area from larger drops, formed due to low interfacial tension and low agitation speeds. With pentane continuous, the water droplets were observed to be big and the agitation intensity was also lower due to flooding.

It can be seen from Figure 10 that the HETS increases with an increase in water-to-solvent ratio, with pentane dispersed. With water dispersed, the change in HETS with increasing water-to-solvent ratio is marginal. A corresponding trend was observed for the increase in HETS with increasing flow rates as seen in Figure 13. Lower HETS values are obtained by dispersing pentane at low flow rates and low water-to-solvent ratios. At higher flow rates and large water-to-solvent ratios, dispersing water results in lower HETS values. For desalter water, the removal efficiency decreased with increasing flow rates and water-to-solvent ratios. The removal efficiency was consistently better with pentane dispersed as seen in Figures 12 and 15.

Synthetic waste water was treated to discharge product water with less than 10 ppm benzene, as seen in Table 2. Desalter water could be extracted to remove 95% of the organics. The suspended particles present in the desalter water were visually observed to be removed by extracting with pentane.

## CHAPTER VI

### CONCLUSIONS AND RECOMMENDATIONS

#### Conclusions

Equilibrium data were generated for the ternary system pentane-benzene-water. The distribution curve of benzene between pentane and water was linear and the distribution coefficient was found to be 594.8 on a weight basis.

The HETS for the ternary system was found to increase with decreasing solvent to water ratio and increased with increasing total flow rates. The percentage reduction in benzene was also found to decrease with increasing total flow rates and decreasing solvent to water ratios. Operation with pentane as the dispersed phase resulted in lower HETS values than with water dispersed at low flow rates and high solvent to water ratios. At high flow rates and low solvent to water ratios, operation with water dispersed resulted in lower HETS values. Hence pentane should be dispersed for high solvent to water ratios (up to 1:15) and low total flow rates (up to 90 ml/min) beyond which dispersing the water provides better efficiency. The column demonstrated that product water with less than 10

ppm benzene could be obtained. This would bring the effluent water in compliance with the NPDES regulations.

Desalter water was extracted using pentane, and the organics could be removed up to 95% of the feed concentration. The contaminants present in desalter water altered the interfacial tension and the plate wettability characteristics. Hence lower agitation speeds required to flood the column. In contrast to the synthetic waste water, for desalter water higher removal efficiencies were obtained with pentane dispersed at all conditions. The suspended particles present in the desalter water were also removed by pentane.

### Recommendations

In this study, water to solvent ratios of 30 have been shown to be successful in treating the synthetic waste water and desalter water. Higher water-to-solvent ratios could be studied for the synthetic waste water, as operation with pentane continuous resulted in a marginal increase in the HETS with increasing water-to-solvent ratios.

Teflon plates which were wet by pentane were used. Stainless steel plates, which are preferentially wet by water, could be used to evaluate the performance of the column with pentane dispersed. This should result in lower HETS values due to the absence of drop-to-drop coalescence.

## BIBLIOGRAPHY

1. Alkhatib, E. A. and Thiem, L. T., [ 1991], "Waste Water Oil Removal Evaluated", Hydrocarbon Processing, August, pp. 77-80.
2. Alexander, D. M., [1959], Journal of Physical Chemistry, 63, pp. 1021-1022.
3. Baird, M. H. I., McGinnis, R. G., and Tan, G. C., [1971], "Flooding Conditions in a Reciprocating Plate Extraction Column", Proc. Int. Solvent Extraction Conf. , pp. 251-259.
4. Baird, M. H. I., and Lane, S. J. , [1973], " Drop Size and Holdup in a Reciprocating Plate Extraction Column", Chemical Eng. Sci. 28, pp.947-957.
5. Barone, G., Crescenzi, V., Pispisa, B. and Quadrifoglio, F., [1966], Journal of Macromolecular Chemistry, 1, pp. 761-771.
6. Chen, H. P., [1993], Ph. D. Thesis, Oklahoma State University
7. Cockshutt, C. D. and Fode G., [1991], "Condensate Clears Up Oily Produced Water", Oils and Gas Journal, November 25, pp. 74-77.
8. Code of Federal Regulations, 40 CFR 261.32 Subpart D
9. Code of Federal Regulations, 40 CFR 63.138 Subpart C

10. Corby, T. C. and Elworthy, P. H., [1971], Journal of Pharmacy and Pharmacology, 23, supplementary, pp. S39-S48.
11. Earhart, J. P., Won, K. W., King, J. C. and Pransnitz J. M., [1976] "Extraction of Chemical Pollutants from Industrial Waste Waters with Volatile Solvents", EPA - 600/2 -76-220, December, pp.78
12. Federal Register, FR 74884
13. Federal Register, FR 11827
14. Filippi, R. D. and Markiewicz, J., [1991], "Propane Extraction", Oil and Gas Journal, September 9, p. 52-54.
15. Hafez, M.M., "A Model for Reciprocating Plate Extraction Columns", ISEC, 80, pp.1-9.
16. Hafez, M.M., Baird, M.H.I., and Nirdosh, I., [1979], "Flooding and Axial Dispersion in Reciprocating Plate Extraction Columns", The Canadian Journal of Chemical Engineering, Vol. 57, April, pp.150-158.
17. Hanson, C., [1971], Recent Advances in Liquid Liquid Extraction, Oxford : Pergamon Press, pp. 161, 166
18. IUPAC, [1983], Solubility Data Series, Vol. 37, pp. 42-85.
19. Jonsson, J. A., Vejrosta, J. and Novak, J., [1982], Fluid Phase Equilibria, 9, pp. 279-286.
20. Karr, A. E., [1959], "Performance of a Reciprocating -Plate Extraction Column", American Institute Chemical Engineering Journal, Vol. 5, No. 4, pp. 446-452.

21. Karr, A. E., [1980], "Design, Scale-up and Applications of the Reciprocating Plate Extraction Column", Separation Science and Technology, 15[4], pp. 877-905.
22. Karr, A. E., Ramanujam, S., Lo, T. C., and Baird, M. H. I., [1987], "Axial Mixing and Scaleup of Reciprocating Plate Columns", The Canadian Journal of Chemical Engineering, Vol. 65, June.
23. Karr, A. E., [1977], "Performance of a 36 in. Diameter Reciprocating Plate Extraction Column", ISEC, pp. 355-361.
24. Karr, A. E., and Lo, T. C., [1971], "Performance and Scale-up of a Reciprocating Plate Extraction Column", Proc. Int. Solvent Extraction Conference 1, 299, pp. 299-320.
25. Karr, A. E., [1976], "Scaleup of Large Diameter Reciprocating-Plate Extraction Column", CEP, pp.68-70.
26. Kiezyk, P. R., and Mackay, D., [1973], "The Screening and Selection of Solvents for the Extraction of Phenol from Water", Canadian Journal of Chemical Engineering, Vol. 51, December, pp. 741-745.
27. Kim, S. D., and Baird, M.H. I., [1976], "Axial Dispersion in a Reciprocating Plate Extraction Column", The Canadian Journal of Chemical Engineering, Vol. 54, February/April, pp.81-89.
28. King, J. C., "Removal and Recovery of Acids and Penols from Dilute Aqueous Streams", ISEC , 80, pp. 66.
29. Lankford, P. W., Eckenfelder, Jr., W. W., and Torrems, K. D., [1988], "Reducing Waste Water Toxicity", Chemical Engineering, November 7, pp. 72-82.



30. Leinonen, P. J. and MacKay, C., [1973], Canadian Journal of Chemical Engineering, 51, pp. 230-233.
31. Lewis, W. Z., and Martin W. L., [1967], "Remove Phenols from Waste Water", Hydrocarbon Processing, February, Vol. 46, No. 2, pp. 131-132.
32. Lo, T. C., and Prochazka, J. [1983]. "Reciprocating-Plate Extraction Columns", in T. C. Lo, et al. [eds.], Handbook of Solvent Extraction, New York: Wiley Interscience, pp. 373-389.
33. Lo, T. C., and Karr, A. E., [1972], paper presented at Engineering Foundation Conference on Mixing Research, Andover, N. H., Aug. 9-13; Ind. Eng. Chem. Process Des. Dev., Vol. 11, No. 4, pp. 495.
34. Mackay, D. and Media, M., [1977], "The Applicability of Solvent Extraction to Waste Water Treatment", ISEC 77, pp. 791-797.
35. McAuliffe, C., [1966], Journal of Physical Chemistry, 70, pp. 1267-1275
36. Minton, R. C., Begbie, R., Tyldsley, D., Park, D., [1991], "Oily Cuttings Cleaning System Ready for Onshore Testing", Ocean Industry, Nov, pp. 54-56.
37. Morrison, T. J. and Billett, F., [1952], Journal of the Chemical Society, pp. 3819-3822.
38. Nelson, H. D. and De Ligny, C. L., [1968], Rec. Trav. Chim. Pays-Bas, 87, pp. 528-544.
39. Osborne, D. A., [1992], "Two Way Step Process Treats Variety of Waste Water Streams", Oil & Gas Journal, September 28, pp. 84-86.

40. Polak, J. and Lu, B. C.-Y, [1973], Canadian Journal of Chemistry, 51, pp. 4018-4023
41. Price, L. C., [1976], American Association of Petroleum Geologists, Bulletin, 60, pp. 213-244.
42. Prochazka, J., Landau, J., Southrada, F., and Heyberger, A., "Reciprocating-Plate Extraction Column", British Chemical Engineering, Jan., Vol. 16, No. 1, pp. 42-44.
43. Raghavan, R., Coles E. and Dietz D., [1991], "Cleaning Evacuated Soil Using Extraction Agents: A State-of-the-Art Review", Journal of Hazardous Materials, No. 26, pp. 81-87
44. Robbins, L. A., [1979], Handbook of Separation Techniques for Chemical Engineers, Schweitzer, P. (ed.), New York, McGraw Hill, pp. 1-267
45. Robillionard, K. R., Thorsen, G. and Grislingas, A., [1974], "Purification of Oily Water by Solvent Extraction", ISEC.
46. Rosen, A. M., and Krylov, V. S., [1974], Chem. Eng. J., 7, 85.
47. Rouz-Guerraz, C., Defives, D. and Durandet, J., [1974]. "Solvent Extraction Using Impregnations in a Porous Medium", ISEC. 80-89.
48. Shelby, S. E., Davis, G. M. and Gray, J. P., [1991]. "Meet New NEDES Permit Limits", Hydrocarbon Processing, August, pp. 67-72.
49. Schweitzer, P. A., [1979], Handbook of Separation Techniques for Chemical Engineers, New York : Mc Graw Hill Book Company.

50. Shen, Z. J., Rao Rama, N. V., and Baird, M.H. I., [1985], " Mass Transfer in a Reciprocating Plate Extraction column -- Effects of Mass Transfer Direction and Plate Material", The Canadian Journal of Chemical Engineering, Vol. 63, February, pp.29-36.
  
51. Sudell, G. W., [1990], "Evaluations of B. E. S. T. Solvent Extraction Sludge Treatment Technology Twenty Four Hour Test", Journal of Hazardous Materials, No. 23, pp. 245 - 249.
  
52. Welleck, R. M., Ozsoy, M. U., Carr, J. J., Thompson, D., Konkle, T. V., [1969], "A Liquid Liquid Extraction Column with Reciprocated Wire Mesh Packing", I&EC Process Design and Development, Vol. 8, No. 4, pp. 515-527
  
53. Wennwesten, R., [ 1974 ], "Extraction of Organic Pollutants from an Effluent Stream in the Manufacture of P-Nitrobenzoic Acid", ISEC.
  
54. Wilson, S. E., [1992], "Toxicity reduction of refinery wastes using pentane extraction", M.S thesis, Oklahoma State University.

## APPENDICES

## APPENDIX A

## ERROR ANALYSIS

The error in the calculated quantities were estimated using error propagation techniques. The HETS is given by equation 1 as

$$\text{HETS} = \frac{H}{\text{NTU}}$$

The error in the HETS was calculated as

$$\begin{aligned}\sigma_{\text{HETS}}^2 &= \left( \frac{\delta \text{HETS}}{\delta \text{NTU}} \right)^2 \sigma_{\text{NTU}}^2 \\ &= \left( \frac{-H}{\text{NTU}^2} \right)^2 \sigma_{\text{NTU}}^2\end{aligned}$$

NTU is defined by equation 2. The error in NTU is found as

$$\sigma_{\text{NTU}}^2 = \left( \frac{-1}{\eta^2 G} \right)^2 \sigma_{\eta}^2 + \sigma_E^2 \frac{E^2}{[E-1]^2} \left[ \ln(G) \left( \frac{1}{E} - \frac{1}{E-1} \right) + \frac{1}{E^2 G} \left( \frac{1}{\eta} - 1 \right) \right]^2$$

where G is given by  $G = \frac{E-1}{\eta E} + \frac{1}{E}$ . The error in  $\eta$  and E is found as

$$\sigma_E^2 = \left( \frac{K_d}{F_w} \right)^2 \sigma_{F_s}^2 - \left( \frac{K_d F_x}{F_w^2} \right)^2 \sigma_{F_w}^2$$

$$\text{and } \sigma_{\eta}^2 = \left( \frac{1}{x_{w0}} \right)^2 \sigma_{x_{w1}}^2 + \left( \frac{-x_{w1}}{x_{w0}^2} \right)^2 \sigma_{x_{w0}}^2$$

The error terms in the above two equations are the errors in the flow rates and the concentrations. The errors in these experimental quantities are calculated by

$$\sigma = \frac{s}{\sqrt{n}}$$

where  $n$  is the number of data points and  $s$  is the sample standard deviation calculated as

$$s^2 = \frac{\sum [Y - \bar{Y}]^2}{n - 1}$$

The errors calculated for the HETS, the percentage reduction in benzene, and the overall removal efficiency for the organics in desalter water are given in Tables A1, A2, and A3.

TABLE A2  
ESTIMATED ERROR IN THE PERCENTAGE  
REDUCTION OF BENZENE

RUN #	% REDUCTION	$\sigma$	% ERROR
1	91.57	0.55	0.74
2	97.81	0.35	0.59
3	98.99	0.43	0.66
4	98.75	0.38	0.61
5	99.83	0.06	0.25
6	94.70	0.49	0.70
7	98.11	0.42	0.65
8	98.85	0.46	0.68
9	99.34	0.36	0.60
10	92.90	1.12	1.30
11	95.55	0.50	0.71
12	94.74	0.47	0.68
13	98.30	0.32	0.56
14	99.47	0.45	0.67
15	99.67	0.05	0.23
16	95.69	0.34	0.59
17	97.29	0.34	0.58
18	94.61	0.56	0.75
19	95.44	0.43	0.66



TABLE A3

ESTIMATED ERROR IN THE OVERALL REMOVAL EFFICIENCY  
OF ORGANICS FROM DESALTER WATER

RUN #	OVERALL REMOVAL EFFICIENCY	$\sigma$	% ERROR
1	94.45	3.77	4.00
2	80.32	10.86	13.52
3	91.88	4.94	5.38
4	81.83	3.86	4.72
5	78.93	2.25	2.85
6	79.15	2.23	2.82
7	74.05	2.76	3.72
8	80.77	2.06	2.56
9	83.06	1.83	2.20
10	58.53	4.37	7.46
11	92.84	0.87	0.94
12	85.78	1.56	1.81
13	84.83	3.57	4.21
14	76.43	2.88	3.76
15	73.91	3.15	4.26
16	88.01	2.89	3.28
17	93.57	1.75	1.87
18	87.09	3.08	3.54
19	91.56	2.15	2.34

## APPENDIX B

TABLE B1  
EQUILIBRIUM DISTRIBUTION DATA OF BENZENE  
BETWEEN PENTANE AND WATER

WEIGHT % BENZENE IN PENTANE	WEIGHT % BENZENE IN WATER
99.97	0.17108
81.00	0.14418
77.90	0.12890
71.44	0.11937
72.82	0.11799
58.66	0.10102
57.63	0.09831
36.56	0.07185
32.44	0.05841
32.02	0.05691
1.03	0.00112
0.88	0.00066

The temperature was not controlled  
and the room temperature was  $24 \pm 2^{\circ}$  C

TABLE B2

DISTRIBUTION DATA FOR ACETIC ACID BETWEEN  
MIBK AND WATER (KARR, 1950)

---

Weight % in Ketone Phase	Weight % in Water Phase
0.58	0.94
0.86	1.39
1.82	2.89
2.83	4.39
3.91	5.91
6.13	8.73
8.51	11.41
10.22	13.42
10.72	13.92
12.97	16.31
15.26	18.65
16.18	19.88
19.13	22.41

---

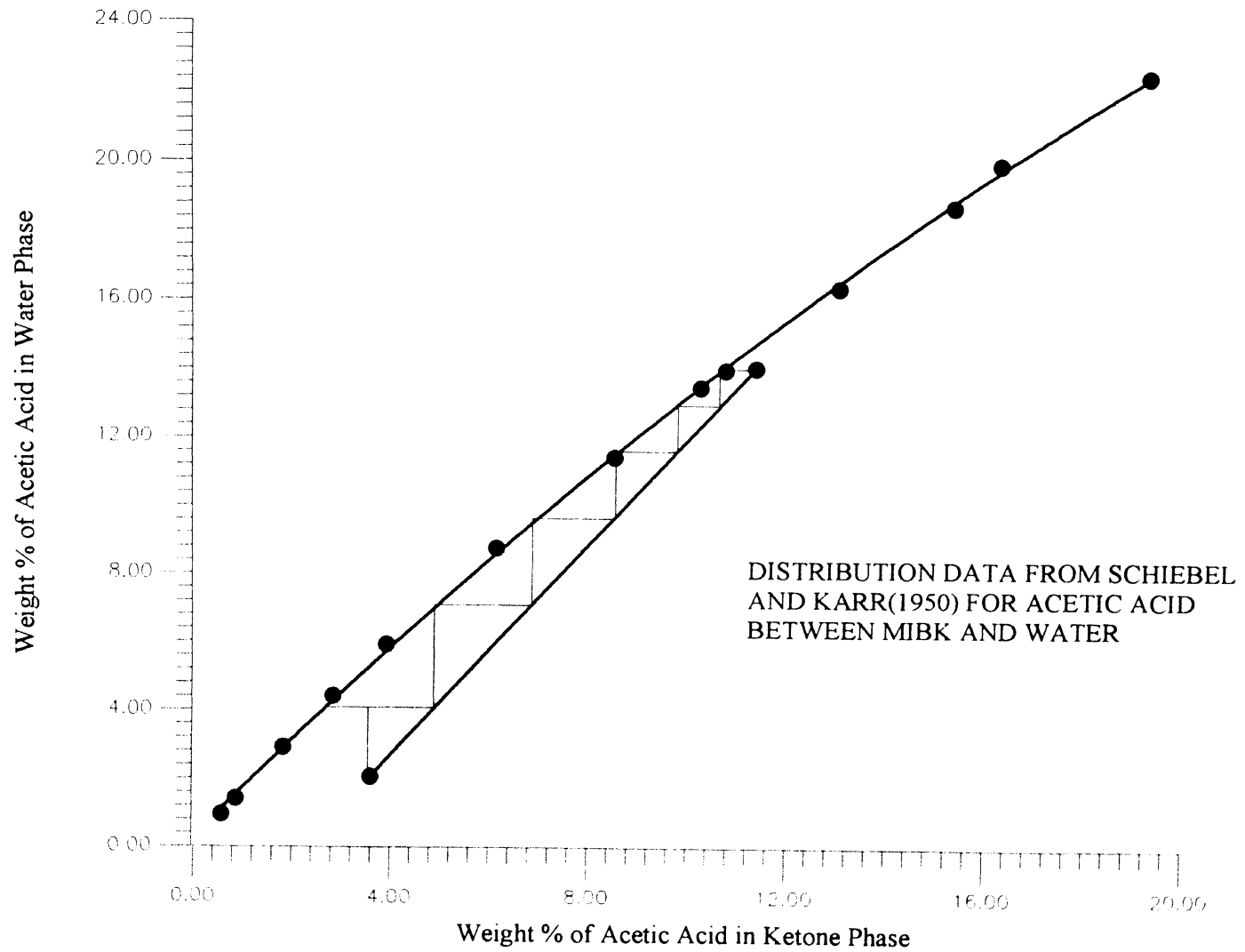

Figure B1. Determination of Number of Theoretical Stages by Graphical Interpolation

VITA

Ramasubramanian Rajagopal

Candidate for the Degree of

Master of Science

Thesis: EVALUATION OF THE RECIPROCATING PLATE  
COLUMN FOR TREATING PETROLEUM WASTE  
WATERS

Major Field: Chemical Engineering

Biographical:

Personal Data: Born in Madurai, India, February 21, 1971, the son of  
Rajagopal S. and Vanitha R.

Education: Graduated from Vikaasa Higher Secondary School,  
Madurai, India, in May 1987; received Bachelor of  
Engineering Degree in Chemical Engineering from Annamalai  
University at Chidambaram in May, 1991; completed  
requirements for the Master of Science degree at Oklahoma  
State University in May, 1994.