

SLOPE DEFLECTION EQUATIONS FOR  
SYMMETRICAL BENT MEMBERS  
BY THE STRING POLYGON  
METHOD

By

GLENN DOUGLAS HOUSER

Bachelor of Architectural Engineering  
Oklahoma State University  
Stillwater, Oklahoma  
1960

Submitted to the faculty of the Graduate School of  
the Oklahoma State University  
in partial fulfillment of the requirements  
for the degree of  
MASTER OF SCIENCE  
May, 1962

NOV 8 1962

SLOPE DEFLECTION EQUATIONS FOR  
SYMMETRICAL BENT MEMBERS  
BY THE STRING POLYGON  
METHOD

Thesis Approved:

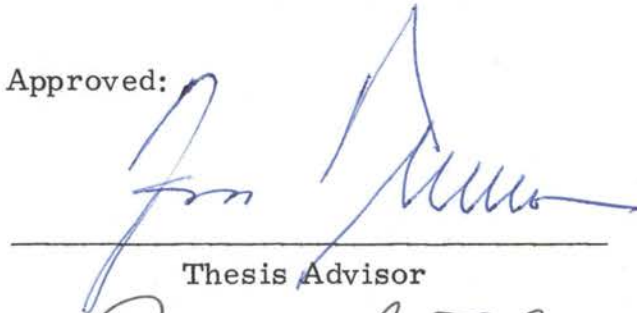

---

Thesis Advisor



---

Faculty Representative



---

Dean of the Graduate School

504506

## PREFACE

The writer wishes to express indebtedness and gratitude to the following persons:

To Professor Tuma for introducing him to the String Polygon Method and its application to the derivation of the slope deflection equations. Also for the Graduate Assistantship awarded him by the School of Civil Engineering, which provided the necessary means for his graduate study and finally, for the guidance and encouragement given the writer during the preparation of this thesis.

To Mrs. Mary Jane Walters for her exceptionally fine job in typing the manuscript and her unfailing good humor which made the preparation of the thesis for printing an enjoyable experience.

To his wife whose love and continual encouragement gave him the incentive to continue his education and buoyed his spirits throughout the period of this study.

And to his parents who stressed the need for higher education. Their assistance and encouragement during the years of his study made this effort possible.

## TABLE OF CONTENTS

Chapter	Page
I. INTRODUCTION . . . . .	1
II. DERIVATION OF THE SLOPE DEFLECTION EQUATIONS . . . . .	3
1. Basic Structure . . . . .	3
2. Deformation Equations . . . . .	4
3. Conjugate Load Functions . . . . .	6
4. Slope Deflection Equations . . . . .	9
III. STRING POLYGON . . . . .	14
1. General . . . . .	14
2. Segmental Elastic Weights . . . . .	14
3. Joint Elastic Weights . . . . .	16
4. String Polygon Functions . . . . .	18
5. Line Through the Elastic Center . . . . .	21
IV. ANGULAR AND LINEAR DISPLACEMENT FUNCTIONS . . . . .	23
1. General . . . . .	23
2. Angular Displacement Functions . . . . .	23
3. Linear Displacement Functions . . . . .	25
V. MOMENT AND FORCE FUNCTIONS . . . . .	27
1. General . . . . .	27
2. Moment Functions . . . . .	27
3. Force Functions . . . . .	28
VI. NUMERICAL PROCEDURE AND NUMERICAL EXAMPLE . . . . .	31
1. Numerical Procedure . . . . .	31
2. Numerical Example . . . . .	32
VII. SUMMARY AND CONCLUSIONS . . . . .	49
BIBLIOGRAPHY . . . . .	50

## LIST OF FIGURES

Figure		Page
2-1	Loaded Structure . . . . .	3
2-2	Basic Structure. . . . .	4
2-3	Loaded Conjugate Structure . . . . .	5
3-1a	Total Conjugate Structure with Continuous Elastic Weights . . . . .	15
3-1b	Segmental Conjugate Structure with Segmental Elastic Weights . . . . .	15
3-1c	Total Conjugate Structure with Segment Elastic Weights . . . . .	15
3-2	Angular and Linear Deformations. . . . .	20
4-1	Angular and Linear Functions . . . . .	24
6-1	Real Structure . . . . .	32
6-2	Basic Bent Member . . . . .	33
6-3	Bending Moment Diagrams. . . . .	34
6-4	Modified Structure . . . . .	41
6-5	Free Body Diagram. . . . .	45
6-6	Free Body Diagram. . . . .	46

## LIST OF TABLES

Table		Page
3-1	Angular Constants . . . . .	17

## NOMENCLATURE

$c_j$	Ordinate of the point $j$ on the structure.
$d_j$	Segment length.
$e$	Ordinate of the line through the elastic center.
$w$	Load intensity.
$x, x', u, u'$	Cross section coordinates.
$y_j$	Ordinate from the line through the elastic center to the point $j$ on the structure.
BM	Bending moment due to loads.
C	Carry-over factor.
CK	Carry-over stiffness factor.
E	Modulus of elasticity.
$E_{AB}$	Angular-linear carry-over value.
F	Angular flexibility.
FM	Fixed-end moment.
FH	Fixed-end thrust.
G	Angular carry-over.
K	Stiffness factor.
L	Span length.
M	End bending moment.
R	End reactions.
S	Translation stiffness factor.
V	End shear.
X, Y, Z	Reactive redundants.

M	Conjugate bending moment.
P	Elastic weight.
R	Conjugate end shear.
V	Conjugate shear.
$\Delta$	End displacement.
$\epsilon$	Relative end displacement due to loads.
$\gamma$	Thrust induction factor.
$\Omega$	Relative end displacement due to thrust.
$\Sigma$	Summation.
$\tau$	Angular load function.
$\theta$	End rotation.

## SIGN CONVENTION

For forces and moments:

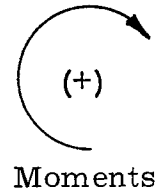
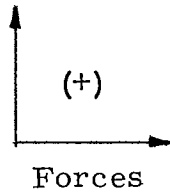

For deformations:

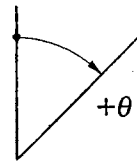
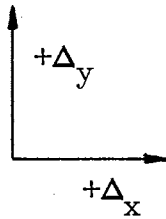

For cross sectional elements:

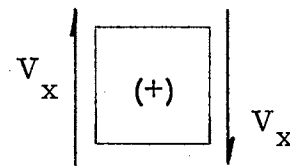
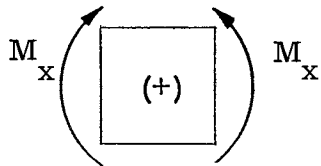

For elastic functions:

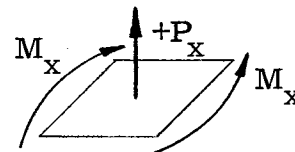
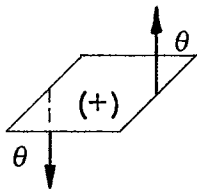
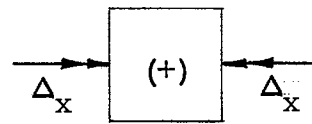
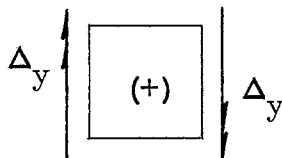



## CHAPTER I

### INTRODUCTION

The purpose of this thesis is to show the application of the String Polygon Method to the calculation of the moment distribution constants for a symmetrical bent member. The historical background of the String Polygon Method was recorded by Tuma<sup>(1)</sup> and will not be repeated here.

The material presented in this thesis is the outgrowth of the Civil Engineering Seminar 620 and reference to the Seminar notes is made. The writer's contribution is the introduction of the bent beam as the simple structure and the application of the String Polygon Method, in connection with this structure, to the calculation of the moment distribution constants.

In the second chapter of this thesis the basic structure is discussed and the deformation of the structure defined in terms of the corresponding conjugate structure. From the conjugate structure three elasto-static equilibrium expressions are derived and simultaneously solved for the slope deflection equations.

The basic ideas of segmental and joint elastic weights, the definition of the string polygon functions, and the location of the line through the elastic center are presented in the third chapter ..

The calculation and definition of the angular and linear displacement functions and the moment and force functions are shown in

chapters four and five respectively. The numerical procedure, application, and final conclusions are recorded in the last two portions of the thesis.

The sign convention and nomenclature are listed under their respective titles. The calculation of deformations is based on the assumption of perfect elasticity and the other customary assumptions of elastic analysis are introduced as the basis for this work.

A list of selected bibliography is made at the close of this thesis but no special reference is made.

## CHAPTER II

### DERIVATION OF THE SLOPE DEFLECTION EQUATIONS

#### 2-1. Basic Structure

A fixed-end, symmetrical bent member of variable cross section acted upon by a general system of loads is considered (Figure 2-1).

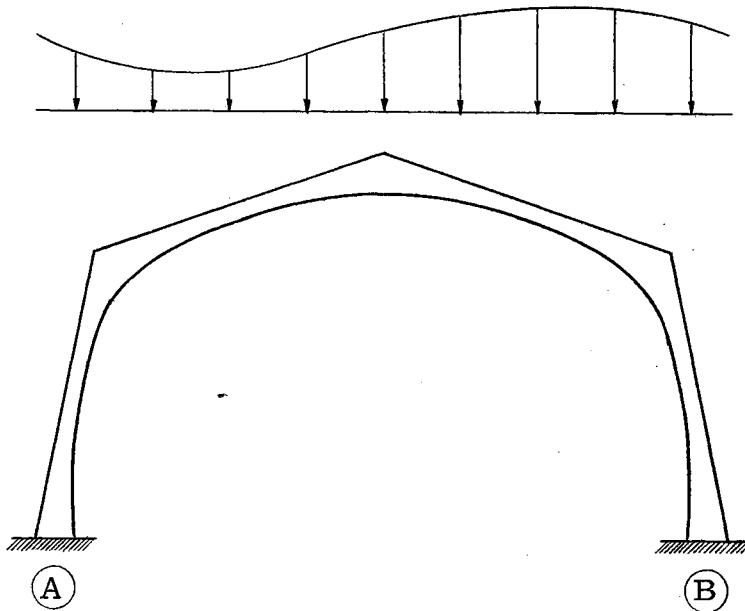

Figure 2-1

Loaded Structure

A simple bent member is introduced as the basic structure (Figure 2-2). The redundant reactions are transferred to points A' and B' located on the horizontal line passing through the elastic center.

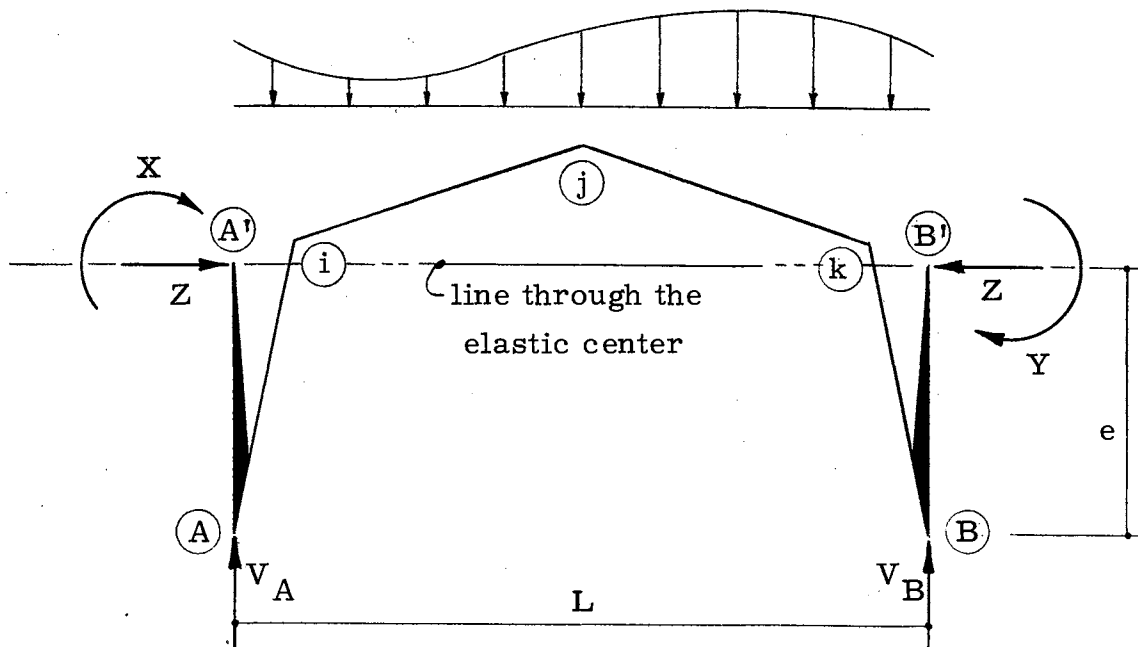

Figure 2-2

## Basic Structure

The end reactions in terms of the loads and redundants  $X$ ,  $Y$ , and  $Z$  are:

$$\begin{array}{l|l}
 R_{AX} = Z & R_{BX} = -Z \\
 R_{AY} = BV_A - \frac{X+Y}{L} & R_{BY} = BV_B + \frac{X+Y}{L} \\
 M_{AB} = X + Ze & M_{BA} = Y - Ze
 \end{array} \quad (2-1)$$

where  $e$  is the ordinate for the line through the elastic center.

A general displacement of the supports is introduced and denoted as:

$$\begin{array}{c|c}
 \begin{array}{ccc}
 \curvearrowleft \theta_A & \overrightarrow{\Delta_{AX}} & \uparrow \Delta_{AY}
 \end{array} &
 \begin{array}{ccc}
 \curvearrowleft \theta_B & \overrightarrow{\Delta_{BX}} & \uparrow \Delta_{BY}
 \end{array}
 \end{array}$$

## 2-2. Deformation Equations

An effort will be made here to show the derivation of the slope deflection equations for a symmetrical bent member by means of the conjugate structure.

The conjugate structure corresponding to the real structure (Figure 2-2) is shown in Figure 2-3 acted upon by the elemental elastic weights and the end deformations. The sign convention for elastic weights and end deformations is defined in the nomenclature.

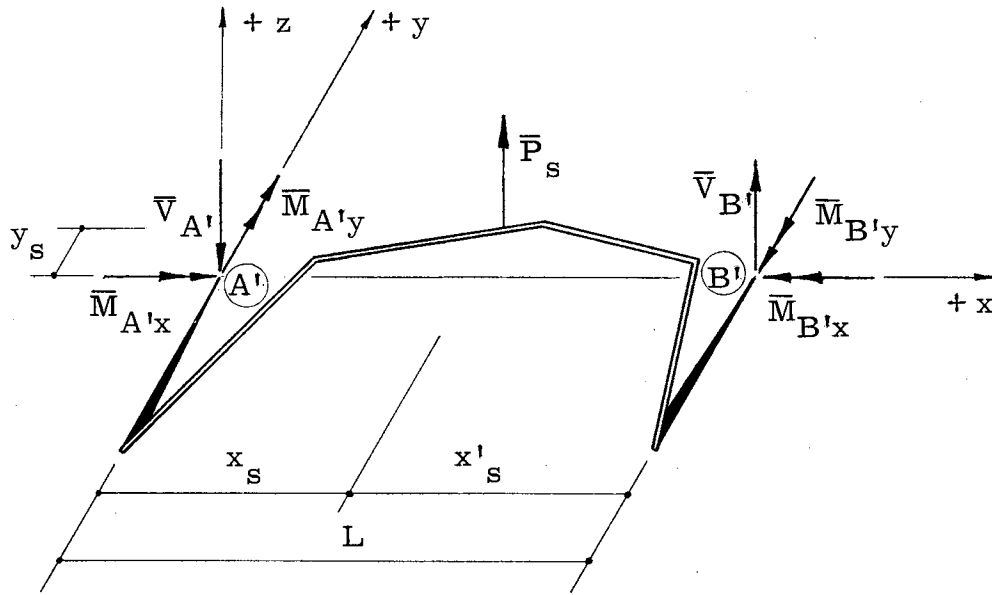

Figure 2-3

### Loaded Conjugate Structure

By summing moments about the  $A_y$ -axis,  $B_y$ -axis, and  $A'B'$ -axis three elasto-static equilibrium equations may be written.

$$\sum M_{B_y} = 0 \quad \curvearrowright$$

$$\bar{V}_{A'} L - \bar{M}_{A'y} - \sum_A^B \bar{P}_s x'_s + \bar{M}_{B'y} = 0 \quad (2-2)$$

$$\sum M_{A_y} = 0 \quad \curvearrowright$$

$$\bar{V}_{B'} L + \bar{M}_{B'y} + \sum_A^B \bar{P}_s x_s - \bar{M}_{A'y} = 0 \quad (2-3)$$

$$\sum M_{A'B'} = 0 \quad \rightarrow$$

$$\bar{M}_{A'x} + \sum_A^B \bar{P}_s y_s - \bar{M}_{B'x} = 0 \quad (2-4)$$

Transposing terms to equate the load terms to the end deformation terms and dividing each term by the length L results in

$$+ \sum_A^B \bar{P}_s \frac{x'_s}{L} = + \theta_{A'} - \frac{\Delta_{A'y}}{L} + \frac{\Delta_{B'y}}{L} \quad (2-5a)$$

$$- \sum_A^B \bar{P}_s \frac{x_s}{L} = + \theta_{B'} - \frac{\Delta_{A'y}}{L} + \frac{\Delta_{B'y}}{L} \quad (2-5b)$$

$$+ \sum_A^B \bar{P}_s y_s = -\Delta_{A'x} + \Delta_{B'x} \quad (2-5c)$$

where

$$\begin{aligned} \bar{V}_{A'} &= \theta_{A'} & \bar{V}_{B'} &= \theta_{B'} \\ \bar{M}_{A'y} &= \Delta_{A'y} & \bar{M}_{B'y} &= \Delta_{B'y} \\ \bar{M}_{A'x} &= \Delta_{A'x} & \bar{M}_{B'x} &= \Delta_{B'x} \end{aligned}$$

### 2-3. Conjugate Load Functions

The elemental elastic weight ( $\bar{P}_s$ ) is a function of the loads and redundants and may be written as

$$\bar{P}_s = \frac{BM_s ds}{EI_s} + X \frac{x'_s ds}{LEI_s} - Y \frac{x_s ds}{LEI_s} - Z \frac{y_s ds}{EI_s} \quad (2-6a)$$

Denoting

$$\begin{aligned} \bar{P}_s^L &= \frac{BM_s ds}{EI_s} \\ &= \text{elemental elastic weight due to loads} \end{aligned}$$

$$\bar{P}_s^x = \frac{x'_s ds}{LEI_s}$$

= elemental elastic weight due to X = 1.0

$$\bar{P}_s^y = - \frac{x_s ds}{LEI_s}$$

= elemental elastic weight due to Y = 1.0

$$\bar{P}_s^z = - \frac{y_s ds}{EI_s}$$

= elemental elastic weight due to Z = 1.0.

Equation (2-6a) becomes

$$\bar{P}_s = \bar{P}_s^L + X\bar{P}_s^x + Y\bar{P}_s^y + Z\bar{P}_s^z. \quad (2-6b)$$

In terms of this notation, the left sides of Equations (2-5) are:

$$\sum_A^B \bar{P}_s \frac{x'_s}{L} = \sum_A^B \bar{P}_s^L \frac{x'_s}{L} + X \sum_A^B \bar{P}_s^x \frac{x'_s}{L} + Y \sum_A^B \bar{P}_s^y \frac{x'_s}{L} + Z \sum_A^B \bar{P}_s^z \frac{x'_s}{L} \quad (2-7a)$$

$$- \sum_A^B \bar{P}_s \frac{x_s}{L} = - \sum_A^B \bar{P}_s^L \frac{x_s}{L} - X \sum_A^B \bar{P}_s^x \frac{x_s}{L} - Y \sum_A^B \bar{P}_s^y \frac{x_s}{L} - Z \sum_A^B \bar{P}_s^z \frac{x_s}{L} \quad (2-7b)$$

$$\begin{aligned} \sum_A^B \bar{P}_s y_s &= \sum_A^B \bar{P}_s^L y_s + X \sum_A^B \bar{P}_s^x y_s \\ &+ Y \sum_A^B \bar{P}_s^y y_s + Z \sum_A^B \bar{P}_s^z y_s. \end{aligned} \quad (2-7c)$$

From symmetry,

$$\begin{array}{l|l} \sum_A^B \bar{P}_s^z \frac{x'_s}{L} = 0 & \sum_A^B \bar{P}_s^x y_s = 0 \\ \sum_A^B \bar{P}_s^z \frac{x_s}{L} = 0 & \sum_A^B \bar{P}_s^y y_s = 0. \end{array}$$

Now it may be observed that Equation (2-7a) represents the left reaction of the conjugate structure, Equation (2-7b) represents the right reaction, and Equation (2-7c) represents the moment of the conjugate structure about the line A'B'.

Denoting

$$\sum_A^B \bar{P}_s^L \frac{x'_s}{L} = \bar{R}_{A'}^L, \quad \sum_A^B \bar{P}_s^L \frac{x_s}{L} = \bar{R}_{B'}^L \quad (2-8a, b)$$

$$\sum_A^B \bar{P}_s^x \frac{x'_s}{L} = \bar{R}_{A'}^x, \quad \sum_A^B \bar{P}_s^x \frac{x_s}{L} = \bar{R}_{B'}^x \quad (2-8c, d)$$

$$\sum_A^B \bar{P}_s^y \frac{x'_s}{L} = \bar{R}_{A'}^y, \quad \sum_A^B \bar{P}_s^y \frac{x_s}{L} = \bar{R}_{B'}^y \quad (2-8e, f)$$

$$\sum_A^B \bar{P}_s^L y_s = \bar{M}_{A'B'}^L, \quad \sum_A^B \bar{P}_s^z y_s = \bar{M}_{A'B'}^z \quad (2-8g, h)$$



the Equations (2-5) reduce to

$$\bar{R}_{A'}^L + X\bar{R}_{A'}^x + Y\bar{R}_{A'}^y = + \theta_{A'} - \frac{\Delta_{A'y}}{L} + \frac{\Delta_{B'y}}{L} \quad (2-9a)$$

$$- \bar{R}_{B'}^L - X\bar{R}_{B'}^x - Y\bar{R}_{B'}^y = + \theta_{B'} - \frac{\Delta_{A'y}}{L} + \frac{\Delta_{B'y}}{L} \quad (2-9b)$$

$$\bar{M}_{A'B'}^L + Z\bar{M}_{A'B'}^Z = - \Delta_{A'x} + \Delta_{B'x} \quad (2-9c)$$

#### 2-4. Slope Deflection Equations

From the simultaneous solution of Equations (2-9) and with new equivalents

$$\bar{N} = \bar{R}_{A'}^x \bar{R}_{B'}^y - \bar{R}_{B'}^x \bar{R}_{A'}^y$$

$$\psi_{A'B'} = \frac{\Delta_{B'y} - \Delta_{A'y}}{L}$$

$$\Delta_{x'} = \Delta_{B'x} - \Delta_{A'x}$$

the redundants become

$$X = \frac{\bar{R}_{B'}^y}{\bar{N}} \theta_{A'} + \frac{\bar{R}_{A'}^y}{\bar{N}} \theta_{B'} + \frac{\bar{R}_{A'}^y + \bar{R}_{B'}^y}{\bar{N}} \psi_{A'B'} + \frac{\bar{R}_{B'}^L \bar{R}_{A'}^y - \bar{R}_{A'}^L \bar{R}_{B'}^y}{\bar{N}} \quad (2-10a)$$

$$Y = - \frac{\bar{R}_{B'}^x}{\bar{N}} \theta_{A'} - \frac{\bar{R}_{A'}^x}{\bar{N}} \theta_{B'} - \frac{\bar{R}_{A'}^x + \bar{R}_{B'}^x}{\bar{N}} \psi_{A'B'} - \frac{\bar{R}_{B'}^L \bar{R}_{A'}^x - \bar{R}_{A'}^L \bar{R}_{B'}^x}{\bar{N}} \quad (2-10b)$$

$$Z = + \frac{1}{\bar{M}_{A'B'}^z} \Delta_{x'} - \frac{\bar{M}_{A'B'}^L}{\bar{M}_{A'B'}^z} \quad (2-10c)$$

These expressions for the redundants are substituted into the Equations (2-1) and the slope deflection equations for forces and moments are obtained.

$$R_{Ax} = + \frac{1}{\bar{M}_{A'B'}^z} \Delta_{x'} - \frac{\bar{M}_{A'B'}^L}{\bar{M}_{A'B'}^z} \quad (2-11a)$$

$$R_{Ay} = BV_A - \frac{\bar{R}_{B'}^y - \bar{R}_{B'}^x}{L\bar{N}} \theta_{A'} - \frac{\bar{R}_{A'}^y - \bar{R}_{A'}^x}{L\bar{N}} \theta_{B'} - \frac{(\bar{R}_{A'}^y + \bar{R}_{B'}^y) - (\bar{R}_{A'}^x + \bar{R}_{B'}^x)}{L\bar{N}} \psi_{A'B'} - \frac{\bar{R}_{B'}^L (\bar{R}_{A'}^y - \bar{R}_{A'}^x) - \bar{R}_{A'}^L (\bar{R}_{B'}^y - \bar{R}_{B'}^x)}{L\bar{N}} \quad (2-11b)$$

$$M_{AB} = \frac{\bar{R}_{B'}^y}{\bar{N}} \theta_{A'} + \frac{\bar{R}_{A'}^y}{\bar{N}} \theta_{B'} + \frac{\bar{R}_{A'}^y + \bar{R}_{B'}^y}{\bar{N}} \psi_{A'B'} + \frac{e}{\bar{M}_{A'B'}^z} \Delta_{x'} + \frac{\bar{R}_{B'}^L \bar{R}_{A'}^y - \bar{R}_{A'}^L \bar{R}_{B'}^y}{\bar{N}} - \frac{\bar{M}_{A'B'}^L}{\bar{M}_{A'B'}^z} e \quad (2-11c)$$

$$R_{Bx} = - \frac{1}{\bar{M}_{A'B'}^z} \Delta_{x'} + \frac{\bar{M}_{A'B'}^L}{\bar{M}_{A'B'}^z} \quad (2-12a)$$

$$\begin{aligned}
R_{By} = & BV_B + \frac{\bar{R}_{B'}^y - \bar{R}_{B'}^x}{L\bar{N}} \theta_{A'} + \frac{\bar{R}_{A'}^y - \bar{R}_{A'}^x}{L\bar{N}} \theta_{B'} \\
& + \frac{(\bar{R}_{A'}^y + \bar{R}_{B'}^y) - (\bar{R}_{A'}^x + \bar{R}_{B'}^x)}{L\bar{N}} \psi_{A'B'} \\
& + \frac{\bar{R}_{B'}^L (\bar{R}_{A'}^y - \bar{R}_{A'}^x) - \bar{R}_{A'}^L (\bar{R}_{B'}^y - \bar{R}_{B'}^x)}{L\bar{N}}
\end{aligned} \tag{2-12b}$$

$$\begin{aligned}
M_{BA} = & - \frac{\bar{R}_{B'}^x}{\bar{N}} \theta_{A'} - \frac{\bar{R}_{A'}^x}{\bar{N}} \theta_{B'} - \frac{\bar{R}_{A'}^x + \bar{R}_{B'}^x}{\bar{N}} \psi_{A'B'} \\
& - \frac{e}{\bar{M}_{A'B'}^z} \Delta_{x'} - \frac{\bar{R}_{B'}^L \bar{R}_{A'}^x - \bar{R}_{A'}^L \bar{R}_{B'}^x}{\bar{N}} \\
& + \frac{\bar{M}_{A'B'}^L}{\bar{M}_{A'B'}^z} e.
\end{aligned} \tag{2-12c}$$

In terms of the end deformations and noting the following equalities,

$$\begin{array}{l|l}
\theta_{A'} = \theta_A & \psi_{A'B'} = \psi_{AB} \\
\theta_{B'} = \theta_B & \Delta_{x'} = \Delta_x - e\theta_A + e\theta_B
\end{array}$$

the Equations (2-11) and (2-12) may be written as

$$\begin{aligned}
R_{Ax} = & - \frac{e}{\bar{M}_{A'B'}^z} \theta_A + \frac{e}{\bar{M}_{A'B'}^z} \theta_B \\
& + \frac{1}{\bar{M}_{A'B'}^z} \Delta_x - \frac{\bar{M}_{A'B'}^L}{\bar{M}_{A'B'}^z}
\end{aligned} \tag{2-13a}$$

$$\begin{aligned}
R_{Ay} = & BV_A - \frac{\bar{R}_{B'}^y - \bar{R}_{B'}^x}{L\bar{N}} \theta_A - \frac{\bar{R}_{A'}^y - \bar{R}_{A'}^x}{L\bar{N}} \theta_B \\
& - \frac{(\bar{R}_{A'}^y + \bar{R}_{B'}^y) - (\bar{R}_{A'}^x + \bar{R}_{B'}^x)}{L\bar{N}} \psi_{AB} \\
& - \frac{\bar{R}_{B'}^L (\bar{R}_{A'}^y - \bar{R}_{A'}^x) - \bar{R}_{A'}^L (\bar{R}_{B'}^y - \bar{R}_{B'}^x)}{L\bar{N}}
\end{aligned} \tag{2-13b}$$

$$\begin{aligned}
M_{AB} = & \left[ \frac{\bar{R}_{B'}^y}{\bar{N}} - \frac{e^2}{\bar{M}_{A'B'}^z} \right] \theta_A + \left[ \frac{\bar{R}_{A'}^y}{\bar{N}} + \frac{e^2}{\bar{M}_{A'B'}^z} \right] \theta_B \\
& + \frac{\bar{R}_{A'}^y + \bar{R}_{B'}^y}{\bar{N}} \psi_{AB} + \frac{e}{\bar{M}_{A'B'}^z} \Delta_x \\
& + \frac{\bar{R}_{B'}^L \bar{R}_{A'}^y - \bar{R}_{A'}^L \bar{R}_{B'}^y}{\bar{N}} - \frac{\bar{M}_{A'B'}^L}{\bar{M}_{A'B'}^z} e
\end{aligned} \tag{2-13c}$$

$$\begin{aligned}
R_{Bx} = & + \frac{e}{\bar{M}_{A'B'}^z} \theta_A - \frac{e}{\bar{M}_{A'B'}^z} \theta_B \\
& - \frac{1}{\bar{M}_{A'B'}^z} \Delta_x + \frac{\bar{M}_{A'B'}^L}{\bar{M}_{A'B'}^z}
\end{aligned} \tag{2-14a}$$

$$\begin{aligned}
R_{By} = & BV_B + \frac{\bar{R}_{B'}^y - \bar{R}_{B'}^x}{L\bar{N}} \theta_A + \frac{\bar{R}_{A'}^y - \bar{R}_{A'}^x}{L\bar{N}} \theta_B \\
& + \frac{(\bar{R}_{A'}^y + \bar{R}_{B'}^y) - (\bar{R}_{A'}^x + \bar{R}_{B'}^x)}{L\bar{N}} \psi_{AB} \\
& + \frac{\bar{R}_{B'}^L (\bar{R}_{A'}^y - \bar{R}_{A'}^x) - \bar{R}_{A'}^L (\bar{R}_{B'}^y - \bar{R}_{B'}^x)}{L\bar{N}}
\end{aligned}$$

(2-14b)

$$\begin{aligned}
M_{BA} = & - \left[ \frac{\bar{R}_{B'}^x}{\bar{N}} - \frac{e^2}{\bar{M}_{A'B'}^z} \right] \theta_A - \left[ \frac{\bar{R}_{A'}^x}{\bar{N}} + \frac{e^2}{\bar{M}_{A'B'}^z} \right] \theta_B \\
& - \frac{\bar{R}_{A'}^x + \bar{R}_{B'}^x}{\bar{N}} \psi_{AB} - \frac{e}{\bar{M}_{A'B'}^z} \Delta_x \\
& - \frac{\bar{R}_{B'}^L \bar{R}_{A'}^x - \bar{R}_{A'}^L \bar{R}_{B'}^x}{\bar{N}} + \frac{\bar{M}_{A'B'}^L}{\bar{M}_{A'B'}^z} e
\end{aligned}$$

(2-14c)

## CHAPTER III

### STRING POLYGON

#### 3-1. General

The extension of the string polygon to the analysis of fixed-end and hinged bent bars was presented by Tuma<sup>(1)</sup>, Oden<sup>(1)</sup>, and Boecker<sup>(2)</sup>. In these works it was shown that the continuous elastic weight can be replaced by the joint elastic weights. For the completeness of this discussion, the basic ideas of segmental and joint elastic weights are restated here.

#### 3-2. Segmental Elastic Weights

The string polygon functions are the end forces and moments of the conjugate structure due to loads and unit redundants. The solution for these functions using the elemental elastic weights entails considerable labor. The total conjugate structure (Figure 3-1a) can be divided into individual straight segments of finite length and each segment may be treated as a separate conjugate beam (Figure 3-1b).

Instead of working with the elemental elastic weight acting on each separate beam, the total elastic weight of each segment may be represented by two end reactions (Figure 3-1b). These segmental reactions must now be applied as the new loads on the total conjugate structure (Figure 3-1c).

By this operation, the following simplifications are achieved:

- A. The continuous elastic weight is replaced by two equivalent forces for each segment.

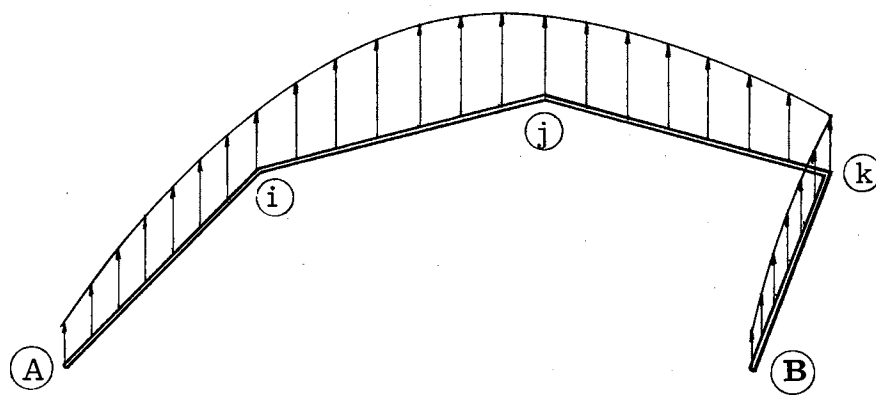

Figure 3-1a

Total Conjugate Structure with Continuous Elastic Weights

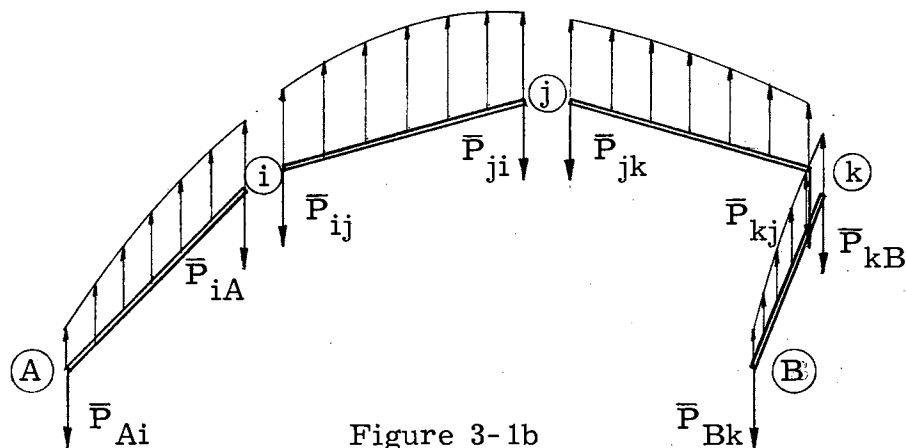

Figure 3-1b

Segmental Conjugate Beams with Segmental Elastic Weights

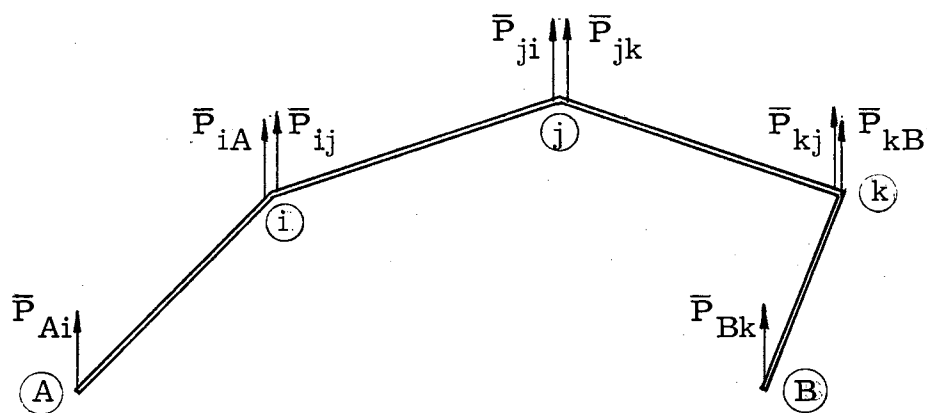

Figure 3-1c

Total Conjugate Structure with Segmental Elastic Weights

- B. These forces are applied at the joints of the conjugate structure making the calculation of the lever arms very feasible (the coordinates of the joints are known from the beginning of the analysis).

The analytical expressions for these segmental elastic loads were derived elsewhere and are

$$\bar{P}_{ji} = M_i G_{ij} + M_j F_{ji} + \tau_{ji} \quad (3-1a)$$

$$\bar{P}_{jk} = M_j F_{jk} + M_k G_{kj} + \tau_{jk} \quad (3-1b)$$

The functions of these equations are the end bending moments  $M_i$ ,  $M_j$ ,  $M_k$ , and the loads acting on the segments. The six angular constants are defined and illustrated in Table 3-1.

The angular constants due to loads ( $\tau$ 's) must be calculated for loads acting normal to the member. If concentrated or continuous loads are applied under a certain angle, the resolution of the loads into normal and tangential components must be performed.

The Equations (3-1) are completely general and applicable to any portion of the bent member.

### 3-3. Joint Elastic Weights

The joint elastic weight ( $\bar{P}_j$ ) is the sum of the segmental elastic weights at a joint and is expressed as

$$\bar{P}_j = \bar{P}_{ji} + \bar{P}_{jk} \quad (3-2)$$

Because the bending moment is a function of the loads and the three redundants, each joint elastic weight may be resolved into joint elastic weights due to loads and the redundants X, Y, and Z. These are

$$\bar{P}_j^L = \bar{P}_{ji}^L + \bar{P}_{jk}^L = \tau_{ji} + \tau_{jk} \quad (3-3a)$$

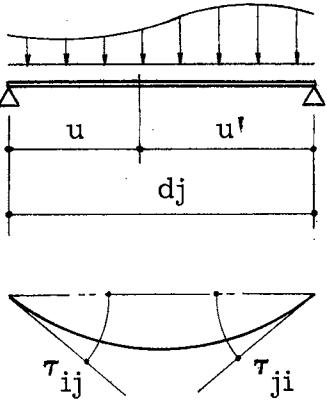
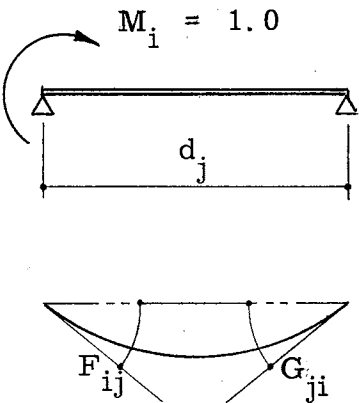
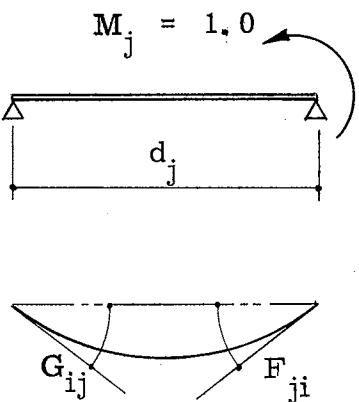

TABLE 3-1	ANGULAR CONSTANTS
	$\tau_{ij} = \int_i^j \frac{BM_u u' du}{d_j EI_u}$ <p>= the end slope of the simple beam at i due to loads.</p> $\tau_{ji} = \int_i^j \frac{BM_u u du}{d_j EI_u}$ <p>= the end slope of the simple beam at j due to loads.</p>
	$F_{ij} = \int_i^j \frac{u'^2 du}{d_j^2 EI_u}$ <p>= the end slope of the simple beam at i due to <math>M_i = 1.0</math>.</p> $G_{ji} = \int_i^j \frac{u u' du}{d_j^2 EI_u}$ <p>= the end slope of the simple beam at j due to <math>M_i = 1.0</math>.</p>
	$F_{ji} = \int_i^j \frac{u^2 du}{d_j^2 EI_u}$ <p>= the end slope of the simple beam at j due to <math>M_j = 1.0</math>.</p> $G_{ij} = \int_i^j \frac{u u' du}{d_j^2 EI_u}$ <p>= the end slope of the simple beam at i due to <math>M_j = 1.0</math>.</p>

$$\begin{aligned}
\bar{P}_j^x &= \bar{P}_{ji}^x + \bar{P}_{jk}^x \\
&= \frac{x'_i}{L} G_{ij} + \frac{x'_j}{L} \Sigma F_j + \frac{x'_k}{L} G_{kj}
\end{aligned} \tag{3-3b}$$

$$\begin{aligned}
\bar{P}_j^y &= \bar{P}_{ji}^y + \bar{P}_{jk}^y \\
&= -\frac{x_i}{L} G_{ij} - \frac{x_j}{L} \Sigma F_j - \frac{x_k}{L} G_{kj}
\end{aligned} \tag{3-3c}$$

$$\begin{aligned}
\bar{P}_j^z &= \bar{P}_{ji}^z + \bar{P}_{jk}^z \\
&= -y_i G_{ij} - y_j \Sigma F_j - y_k G_{kj}
\end{aligned} \tag{3-3d}$$

By these joint elastic weights the deformation of the real structure is fully defined.

#### 3-4. String Polygon Functions

It was proven elsewhere that the shear of the conjugate structure at a given joint, when loaded by the joint elastic weights, is equal to the slope of the real structure at that point. Also, the bending moment of the conjugate structure at this point about a given line is the displacement of that point on the real structure in the direction of that line.

From these two theorems the calculation of the angular and linear deformations of a bent member may be easily performed.

- A. The slope at the point A' on the real structure due to loads or redundants is equal to the shear of the conjugate structure at A' due to the corresponding elastic weights (Figure 3-2).

$$\bar{R}_{A'}^L = \sum_A^B \bar{P}_j^L \frac{x'_j}{L} \tag{3-4a}$$

$$\bar{R}_{A'}^x = \sum_A^B \bar{P}_j^x \frac{x'_j}{L} \quad (3-4b)$$

$$\bar{R}_{A'}^y = \sum_A^B \bar{P}_j^y \frac{x'_j}{L} \quad (3-4c)$$

$$\bar{R}_{A'}^z = \sum_A^B \bar{P}_j^z \frac{x'_j}{L} = 0 \quad (3-4d)$$

B. The slope at the point B' of the real structure due to loads or redundants is equal to the end shear of the conjugate structure at B' due to the corresponding elastic weights.

(Figure 3-2).

$$\bar{R}_{B'}^L = \sum_A^B \bar{P}_j^L \frac{x_j}{L} \quad (3-5a)$$

$$\bar{R}_{B'}^x = \sum_A^B \bar{P}_j^x \frac{x_j}{L} \quad (3-5b)$$

$$\bar{R}_{B'}^y = \sum_A^B \bar{P}_j^y \frac{x_j}{L} \quad (3-5c)$$

$$\bar{R}_{B'}^z = \sum_A^B \bar{P}_j^z \frac{x_j}{L} = 0 \quad (3-5d)$$

C. The relative displacement of the points A' and B' on the real structure due to loads or redundants is equal to the static moment of the corresponding joint elastic weights about the line A'B' (Figure 3-2).

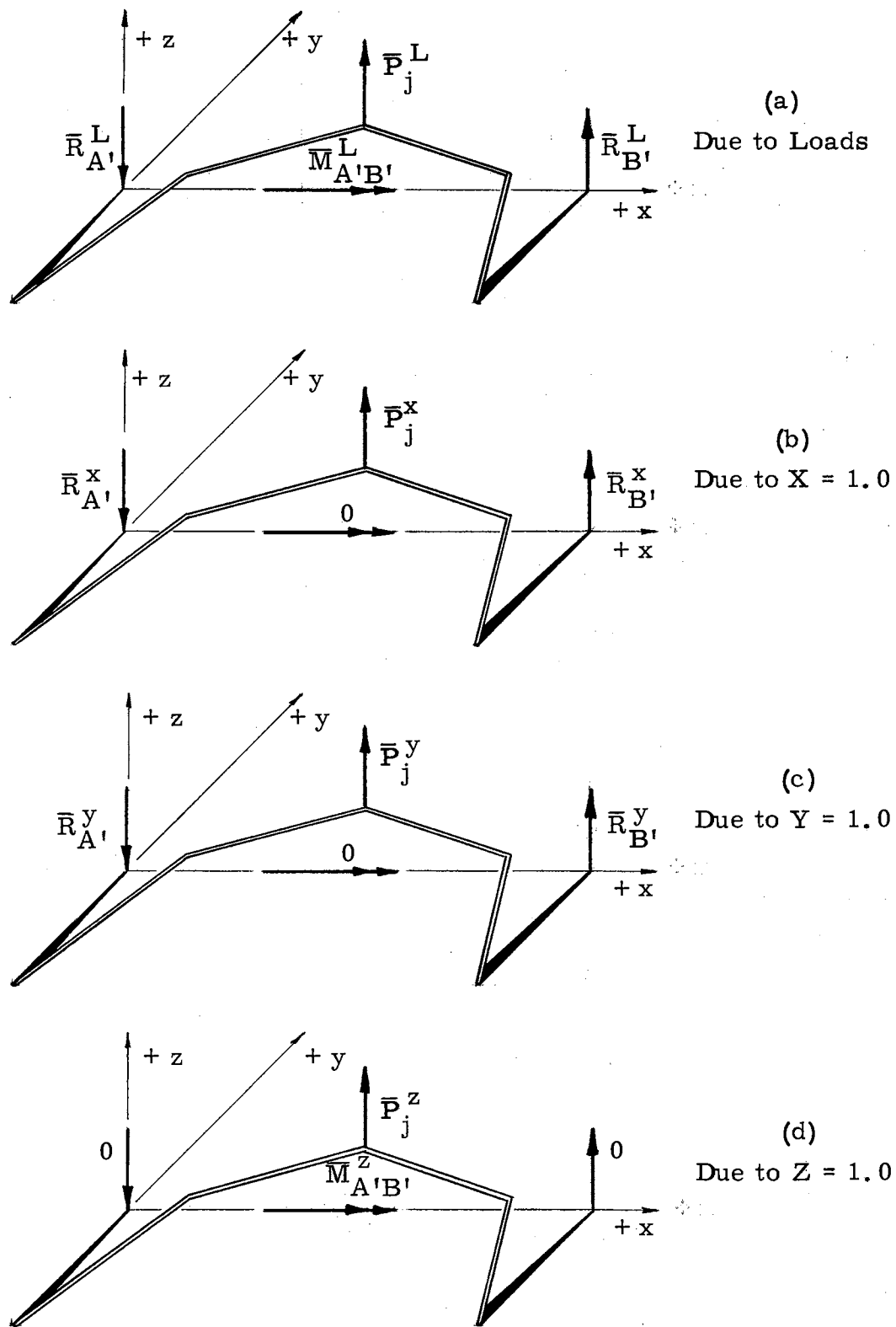

Figure 3-2

Angular and Linear Deformations

$$\bar{M}_{A'B'}^L = \sum_A^B \bar{P}_j^L y_j \quad (3-6a)$$

$$\bar{M}_{A'B'}^x = \sum_A^B \bar{P}_j^x y_j = 0 \quad (3-6b)$$

$$\bar{M}_{A'B'}^y = \sum_A^B \bar{P}_j^y y_j = 0 \quad (3-6c)$$

$$\bar{M}_{A'B'}^z = \sum_A^B \bar{P}_j^z y_j \quad (3-6d)$$

### 3-5. Line Through the Elastic Center

The calculation of the ordinate for the line through the elastic center of a symmetrical bent member may be easily accomplished by means of the conjugate structure.

By definition, this ordinate  $e$  is that distance from the base line  $AB$  at which an applied end moment causes no relative displacement of the points  $A'$  and  $B'$  on the real basic structure. In terms of the conjugate functions, this means that

$$\begin{aligned} \bar{M}_{A'B'}^x = \sum_A^B \bar{P}_j^x y_j &= \sum_A^B \left( G_{ij} \frac{x'_i}{L} + \Sigma F_j \frac{x'_j}{L} \right. \\ &\quad \left. + G_{kj} \frac{x'_k}{L} \right) y_j = 0 \end{aligned} \quad (3-7a)$$

or

$$\begin{aligned} \bar{M}_{A'B'}^y = \sum_A^B \bar{P}_j^y y_j &= - \sum_A^B \left( G_{ij} \frac{x_i}{L} + \Sigma F_j \frac{x_j}{L} \right. \\ &\quad \left. + G_{kj} \frac{x_k}{L} \right) y_j = 0 . \end{aligned} \quad (3-7b)$$

Adding the above equations and noting that  $x'_j + x_j = L$ , the result is

$$\sum_A^B (G_{ij} \frac{L}{L} + \Sigma F_j \frac{L}{L} + G_{kj} \frac{L}{L}) y_j = 0 \quad (3-8a)$$

from which

$$\sum_A^B (G_{ij} + \Sigma F_j + G_{kj}) y_j = 0. \quad (3-8b)$$

The distance  $y_j$  may be expressed as

$$y_j = c_j - e$$

where  $c_j$  is the perpendicular distance from the base line AB to the joint  $j$ . Using this expression for  $y_j$  the value of  $e$  may be found by solving Equation (3-8b). The equation for  $e$  becomes

$$e = \frac{\sum_A^B (G_{ij} + \Sigma F_j + G_{kj}) c_j}{\sum_A^B (G_{ij} + \Sigma F_j + G_{kj})} = \frac{\bar{S}_{AB}}{\bar{A}_{AB}} \quad (3-9)$$

## CHAPTER IV

### ANGULAR AND LINEAR DISPLACEMENT FUNCTIONS

#### 4-1. General

From the previous investigations it becomes clear that several angular and linear functions will be involved. The two theorems for the angular and linear deformations of a bent member are again applicable. Utilizing these theorems the end functions may now be expressed.

#### 4-2. Angular Displacement Functions

The angular functions of the ends A and B on the real structure due to loads and redundants are

- A. The end slope at A (B) of the real structure due to loads is equal to the shear of the conjugate structure at A (B) due to the corresponding elastic weights (Figure 4-1a).

$$\bar{R}_A^L = \bar{R}_{A'}^L = \sum_A^B \bar{P}_j^L \frac{x_j'}{L} = \tau_{AB} \quad (4-1a)$$

$$\bar{R}_B^L = \bar{R}_{B'}^L = \sum_A^B \bar{P}_j^L \frac{x_j}{L} = \tau_{BA} \quad (4-1b)$$

- B. The end slope at A (B) of the real structure due to  $X = 1.0$  is equal to the shear of the conjugate structure at A (B) due to the corresponding elastic weights (Figure 4-1b).

$$\bar{R}_A^X = \bar{R}_{A'}^X = \sum_A^B \bar{P}_j^X \frac{x_j'}{L} = F_{AB} \quad (4-2a)$$

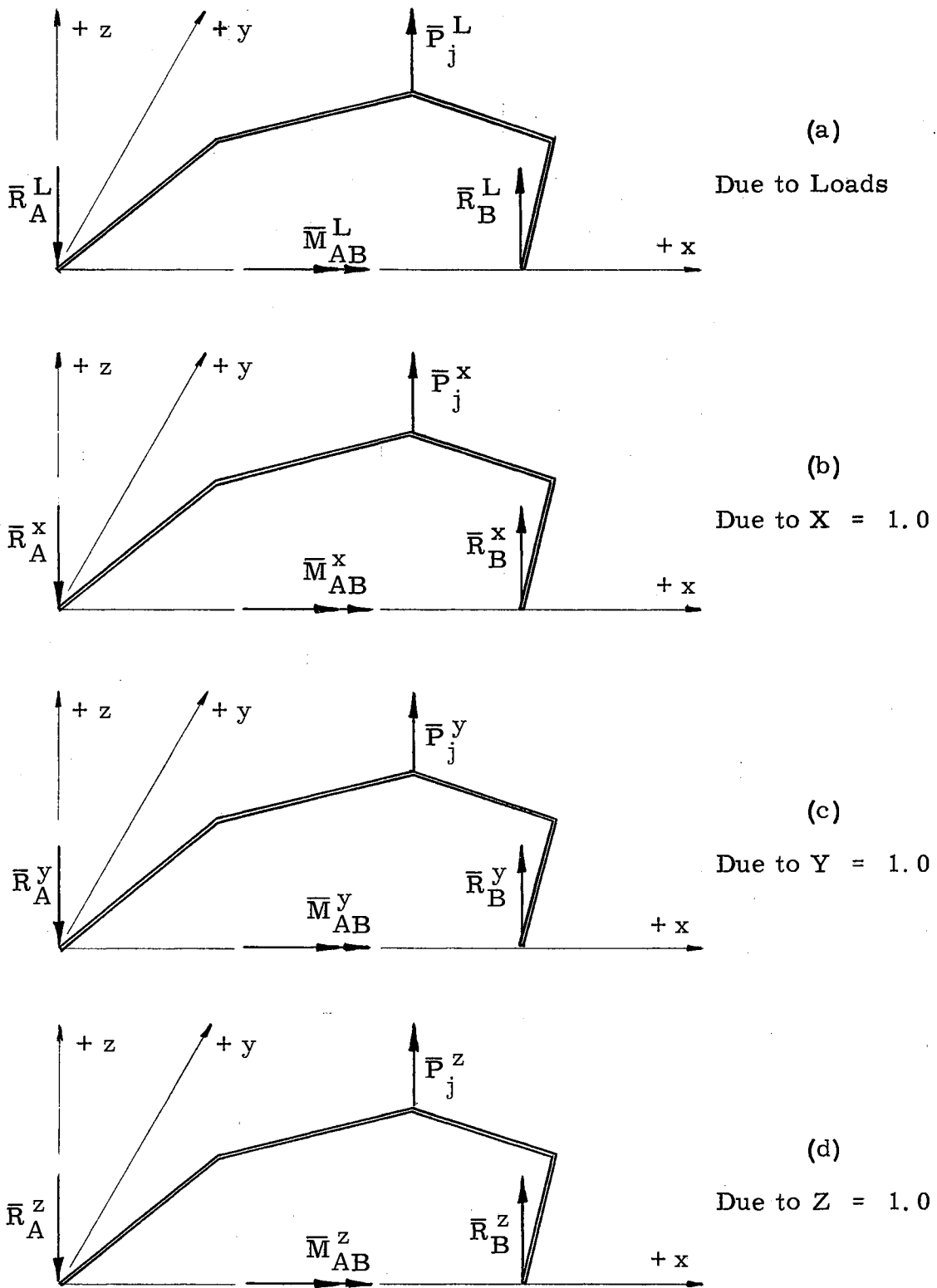

Figure 4-1

Angular and Linear Functions



$$\bar{R}_B^x = \bar{R}_{B'}^x = \sum_A^B \bar{P}_j^x \frac{x_j}{L} = G_{BA} \quad (4-2b)$$

C. The end slope at A (B) of the real structure due to  $Y = 1.0$  is equal to the shear of the conjugate structure at A (B) due to the corresponding elastic weights (Figure 4-1c).

$$\bar{R}_A^y = \bar{R}_{A'}^y = \sum_A^B \bar{P}_j^y \frac{x'_j}{L} = G_{AB} \quad (4-3a)$$

$$\bar{R}_B^y = \bar{R}_{B'}^y = \sum_A^B \bar{P}_j^y \frac{x_j}{L} = F_{BA} \quad (4-3b)$$

#### 4-3. Linear Displacement Functions

The linear functions of the ends A and B on the real structure due to loads and redundants are

A. The relative displacement of the ends A and B on the real structure due to loads is equal to the static moment of the corresponding joint elastic weights about the line AB of the conjugate structure (Figure 4-1a).

$$\begin{aligned} \bar{M}_{AB}^L &= \bar{M}_{A'B'}^L + (\bar{R}_{A'}^L + \bar{R}_{B'}^L) e \\ &= \sum_A^B \bar{P}_j^L c_j = \epsilon_{AB} \end{aligned} \quad (4-4)$$

B. The relative displacement of the ends A and B on the real structure due to  $X = 1.0$  is equal to the static moment of the corresponding joint elastic weights about the line AB of the conjugate structure (Figure 4-1b).

## CHAPTER V

### MOMENT AND FORCE FUNCTIONS

#### 5-1. General

The bent member develops moment and force functions which are expressed in terms of the string polygon functions due to the loads and unit redundants. These moment and force functions, from Equations (2-13) and (2-14), are defined here.

#### 5-2. Moment Functions

The moment functions for the bent member are the deformation coefficients for the end rotations and the fixed-end moments, due to the loads and horizontal end displacements, which induce the end moments. These functions are

- A. The stiffness factor  $K$  is the moment required to induce a unit rotation at the near hinged end, the far end being fixed.

$$K_{AB} = + \frac{\bar{R}_{B'}^y}{\bar{N}} - \frac{e^2}{\bar{M}_{A'B'}^z} \quad (5-1a)$$

$$K_{BA} = - \frac{\bar{R}_{A'}^x}{\bar{N}} - \frac{e^2}{\bar{M}_{A'B'}^z} \quad (5-1b)$$

- B. The carry-over stiffness factor  $CK$  is the moment induced at the near fixed end due to a unit rotation at the far hinged end.

$$CK_{AB} = -\frac{\bar{R}_{B'}^x}{\bar{N}} + \frac{e^2}{\bar{M}_{A'B'}^z} \quad (5-2a)$$

$$CK_{BA} = +\frac{\bar{R}_{A'}^y}{\bar{N}} + \frac{e^2}{\bar{M}_{A'B'}^z} \quad (5-2b)$$

C. The translation stiffness factor  $S$  is the moment of the fixed-end member due to a unit rotation caused by a relative vertical displacement of the ends.

$$S_{AB} = +\frac{\bar{R}_{A'}^y + \bar{R}_{B'}^y}{\bar{N}} \quad (5-3a)$$

$$S_{BA} = -\frac{\bar{R}_{A'}^x + \bar{R}_{B'}^x}{\bar{N}} \quad (5-3b)$$

D. The fixed-end moment due to loads  $FM^L$  is

$$FM_{AB}^L = +\frac{\bar{R}_{B'}^L \bar{R}_{A'}^y - \bar{R}_{A'}^L \bar{R}_{B'}^y}{\bar{N}} - \frac{\bar{M}_{A'B'}^L}{\bar{M}_{A'B'}^z} e \quad (5-4a)$$

$$FM_{BA}^L = -\frac{\bar{R}_{B'}^L \bar{R}_{A'}^x - \bar{R}_{A'}^L \bar{R}_{B'}^x}{\bar{N}} + \frac{\bar{M}_{A'B'}^L}{\bar{M}_{A'B'}^z} e \quad (5-4b)$$

E. The fixed-end moment due to horizontal end displacement  $FM^\Delta$  is

$$FM_{AB}^\Delta = +\frac{e}{\bar{M}_{A'B'}^z} \Delta_x \quad (5-5a)$$

$$FM_{BA}^\Delta = -\frac{e}{\bar{M}_{A'B'}^z} \Delta_x \quad (5-5b)$$

### 5-3. Force Functions

The force functions for the bent member are the deformation

coefficients for the end rotations and the fixed-end thrusts, due to the loads and horizontal end displacements, which induce the end thrusts.

These functions are

- A. The stiffness factor  $K_{AB}^H$  is the horizontal thrust produced by the unit rotation at the near hinged end, the far end being fixed.

$$K_{AB}^H = - \frac{e}{\bar{M}_{A'B'}^z} \quad (5-6a)$$

$$K_{BA}^H = - \frac{e}{\bar{M}_{A'B'}^z} \quad (5-6b)$$

- B. The carry-over stiffness factor  $CK_{AB}^H$  is the horizontal thrust induced at the near fixed end due to a unit rotation at the far hinged end.

$$CK_{AB}^H = + \frac{e}{\bar{M}_{A'B'}^z} \quad (5-7a)$$

$$CK_{BA}^H = + \frac{e}{\bar{M}_{A'B'}^z} \quad (5-7b)$$

- C. The fixed-end thrust due to loads  $FH_{AB}^L$  is

$$FH_{AB}^L = - \frac{\bar{M}_{A'B'}^L}{\bar{M}_{A'B'}^z} \quad (5-8a)$$

$$FH_{BA}^L = + \frac{\bar{M}_{A'B'}^L}{\bar{M}_{A'B'}^z} \quad (5-8b)$$

D. The fixed-end thrust due to horizontal end displacement

$FH^{\Delta}$  is

$$FH_{AB}^{\Delta} = + \frac{1}{\bar{M}_{A'B'}^z} \Delta_x \quad (5-9a)$$

$$FH_{BA}^{\Delta} = - \frac{1}{\bar{M}_{A'B'}^z} \Delta_x \quad (5-9b)$$

## CHAPTER VI

### NUMERICAL PROCEDURE AND NUMERICAL EXAMPLE

#### 6-1. Numerical Procedure

The calculation of the constants discussed in the preceding chapters of this thesis may be performed by this following procedure:

1. The real structure is transformed into the basic structure and the reactions due to loads are calculated.
2. The points of the string polygon are selected and the bending moments of the basic structure are recorded for each ridged joint, or any other point of the string polygon, to obtain the segmental end moments for the string polygon functions.
3. The angular constants (F's, G's, and  $\tau$ 's) are calculated for each segment. If the segments are of variable cross section, numerical tables prepared by Lassley<sup>(3)</sup>, Boecker<sup>(2)</sup>, Exline<sup>(4)</sup>, and Yu<sup>(5)</sup> for the calculation of these constants may be used to great advantage.
4. The joint elastic weights (Equations 3-1 and 3-2) due to a unit bending moment throughout the structure are calculated and applied on the corresponding conjugate structure. The vertical coordinate of the elastic center is calculated by means of the given formula (Equation 3-9).
5. The joint elastic weights are calculated for all joints of the string polygon in terms of the loads and unit redundants.

6. The end conditioning elements of the conjugate structure at A' and B' are calculated by means of the given formulas (Equations 3-4, 3-5, and 3-6.)
7. The numerical values of the end conditioning elements are substituted into the formulas for the end reactions of the real structure (Equations 2-13 and 2-14).

From this point, conventional methods of analysis are utilized for the calculation of any remaining reactive values required for the completion of the problem.

### 6-2. Illustrative Example

The application of the numerical procedure is shown in the following problem. The symmetrical, complex frame loaded as shown (Figure 6-1) is given. It is required to analyze the frame for the joint bending moments. All values given are in units of kips, feet, or kip-feet.

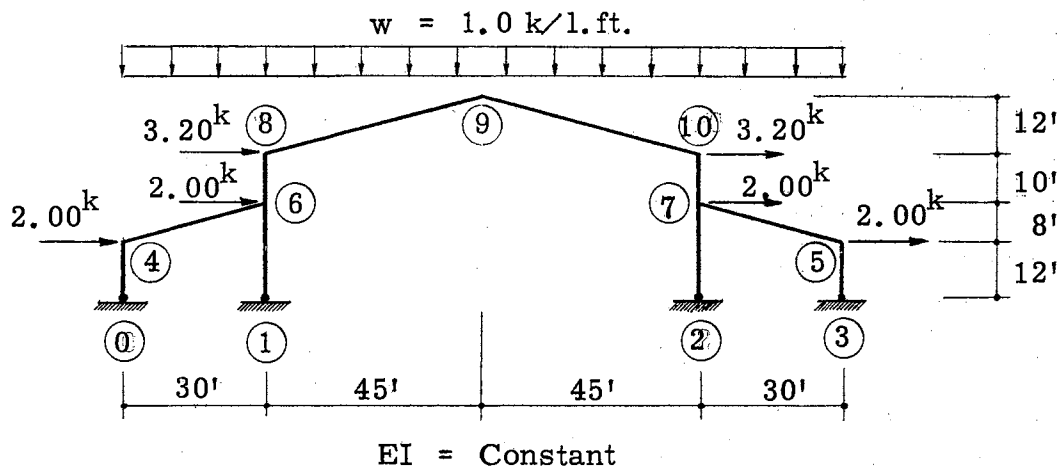

Figure 6-1

Real Structure

The symmetrical bent member (Figure 6-2) is removed for separate analysis. The solution of the member follows the procedure outlined in the preceding article.

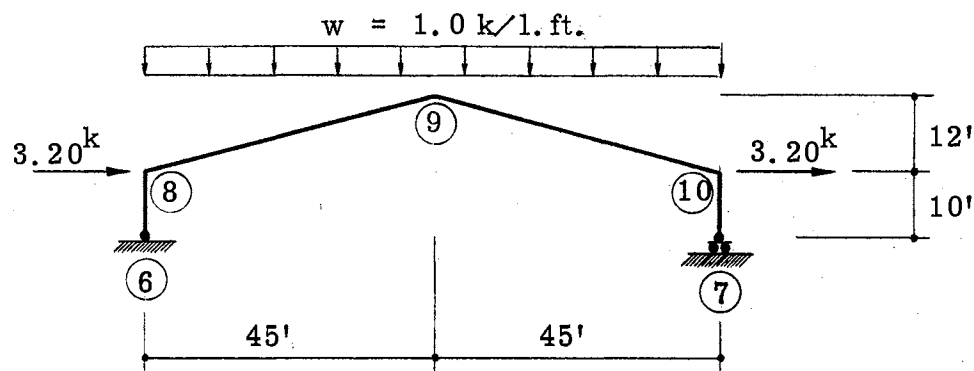

Figure 6-2

## Basic Bent Member

1. Load Reactions

Vertical Loads:

$$R_{6x} = 0$$

$$R_{7x} = 0$$

$$R_{6y} = 45.000^k$$

$$R_{7y} = 45.000^k$$

Horizontal Loads:

$$R_{6x} = 6.400^k$$

$$R_{7x} = 0$$

$$R_{6y} = 0.711^k$$

$$R_{7y} = 0.711^k$$

2. Bending Moment Diagrams (Figure 6-3)3. Angular Constants

$$F_{68} = F_{86} = F_{710} = F_{107} = \frac{L}{3EI} = \frac{10}{3EI} = \frac{3.333}{EI}$$

$$F_{89} = F_{98} = F_{910} = F_{109} = \frac{46.573}{3EI} = \frac{15.524}{EI}$$



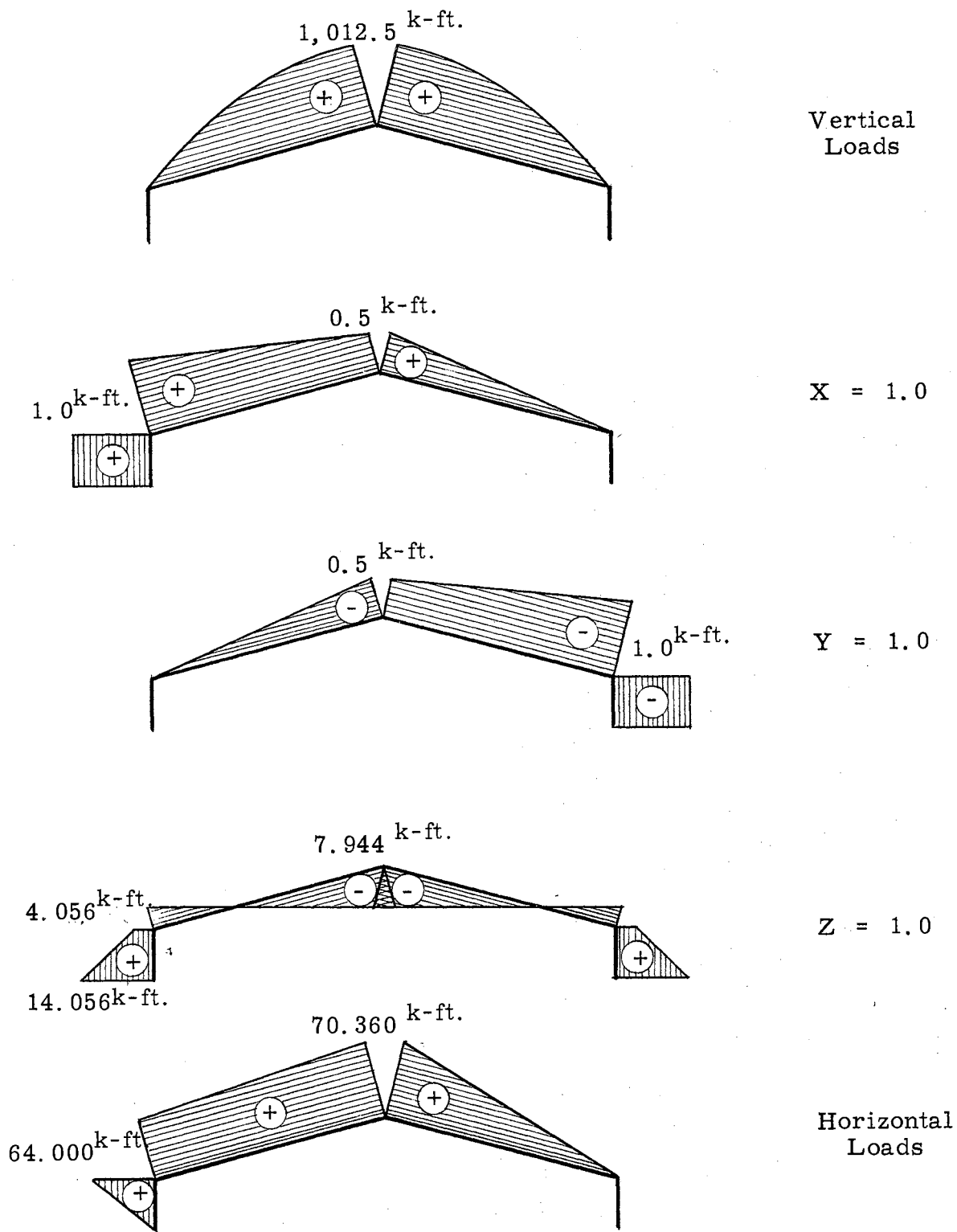

Figure 6-3

Bending Moment Diagrams

$$G_{68} = G_{86} = G_{710} = G_{107} = \frac{L}{6EI} = \frac{1.667}{EI}$$

$$G_{89} = G_{98} = G_{910} = G_{109} = \frac{46.573}{6EI} = \frac{7.762}{EI}$$

$$\tau_{89} = \tau_{98} = \tau_{910} = \tau_{109} = \frac{\omega \cos^2(\alpha)L^3}{24EI} = \frac{3,929.268}{EI}$$

#### 4. Elastic Center Ordinate

$$e = \frac{\sum_A^B (G_{ij} + \Sigma F_j + G_{kj}) C_j}{\sum_A^B (G_{ij} + \Sigma F_j + G_{kj})}$$

$$= \frac{(2)(28.286)(10.0) + (46.572)(22.0)}{(2)(5.000) + (2)(28.286) + (46.572)}$$

$$= \frac{1,590.304}{113.144} = 14.056 \text{ ft.}$$

#### 5. Joint Elastic Weights

Vertical Loads:

$$\bar{P}_6 = \bar{P}_7 = 0$$

$$\begin{aligned} \bar{P}_8 = \bar{P}_{10} &= \tau_{89} + M_9 G_{98} \\ &= \frac{3,929.268}{EI} + (1,012.500) \frac{7.762}{EI} \\ &= + \frac{11,788.293}{EI} \end{aligned}$$

$$\begin{aligned} \bar{P}_{10} &= \tau_{98} + \tau_{910} + M_9 \Sigma F_9 \\ &= (2) \frac{3,929.268}{EI} + (1,012.500)(2) \frac{15.524}{EI} \\ &= + \frac{39,294.636}{EI} \end{aligned}$$

Horizontal Loads:

$$\bar{P}_6 = M_8 G_{86} = (64.000) \frac{1.667}{EI} = + \frac{106.688}{EI}$$

$$\bar{P}_7 = 0$$

$$\begin{aligned} \bar{P}_8 &= M_8 \Sigma F_8 + M_9 G_{98} \\ &= (64.000) \frac{3.333 + 15.524}{EI} + (70.360) \frac{7.762}{EI} \\ &= + \frac{1,752.982}{EI} \end{aligned}$$

$$\begin{aligned} \bar{P}_9 &= M_8 G_{89} + M_9 \Sigma F_9 \\ &= (64.000) \frac{7.762}{EI} + (70.360)(2) \frac{15.524}{EI} \\ &= + \frac{2,681.305}{EI} \end{aligned}$$

$$\bar{P}_{10} = M_9 G_{910} = (70.360) \frac{7.762}{EI} = + \frac{546.134}{EI}$$

X = 1.0:

$$\begin{aligned} \bar{P}_6 &= M_6 F_{68} + M_8 G_{86} = (1.000) \frac{3.333 + 1.167}{EI} \\ &= + \frac{5.000}{EI} \end{aligned}$$

$$\bar{P}_7 = 0$$

$$\begin{aligned} \bar{P}_8 &= M_6 G_{68} + M_8 \Sigma F_8 + M_9 G_{98} \\ &= (1.000) \frac{1.167 + 3.333 + 15.524}{EI} + (0.500) \frac{7.762}{EI} \\ &= + \frac{24.405}{EI} \end{aligned}$$

$$\begin{aligned} \bar{P}_9 &= M_8 G_{89} + M_9 \Sigma F_9 \\ &= (1.000) \frac{7.762}{EI} + (0.500)(2) \frac{15.524}{EI} \\ &= + \frac{23.286}{EI} \end{aligned}$$

$$\bar{P}_{10} = M_9 G_{910} = (0.500) \frac{7.762}{EI} = + \frac{3.881}{EI}$$

Y = 1.0 :

$$\bar{P}_6 = 0$$

$$\bar{P}_7 = M_7 F_{710} + M_{10} G_{107} = - \frac{5.000}{EI}$$

$$\bar{P}_8 = M_9 G_{98} = - \frac{3.881}{EI}$$

$$\bar{P}_9 = M_9 \Sigma F_9 + M_{10} G_{109} = - \frac{23.286}{EI}$$

$$\bar{P}_{10} = M_9 G_{910} + M_{10} \Sigma F_{10} + M_7 G_{710} = - \frac{24.405}{EI}$$

Z = 1.0 :

$$\begin{aligned} \bar{P}_6 = \bar{P}_7 &= M_6 F_{68} + M_8 G_{86} \\ &= (14.056) \frac{3.333}{EI} + (4.056) \frac{1.167}{EI} \\ &= + \frac{53.160}{EI} \end{aligned}$$

$$\begin{aligned} \bar{P}_8 = \bar{P}_{10} &= M_6 G_{68} + M_8 \Sigma F_8 + M_9 G_{98} \\ &= (14.056) \frac{1.167}{EI} + (4.056) \frac{3.333 + 15.524}{EI} \\ &\quad + (-7.944) \frac{7.762}{EI} = + \frac{38.254}{EI} \end{aligned}$$

$$\begin{aligned} \bar{P}_9 &= M_8 G_{89} + M_9 \Sigma F_9 + M_{10} G_{109} \\ &= (4.056)(2) \frac{7.762}{EI} + (-7.944)(2) \frac{15.524}{EI} \\ &= - \frac{183.680}{EI} \end{aligned}$$

## 6. End Conditioning Elements

Vertical Loads:

$$\begin{aligned}\bar{R}_{6'}^V &= \bar{R}_{7'}^V = \sum_6^7 \bar{P}_j \frac{x_j}{L} \\ &= \frac{11,788.293 + (0.50)(39,294.636)}{EI} \\ &= + \frac{31,435.611}{EI}\end{aligned}$$

$$\begin{aligned}\bar{M}_{6'7'}^V &= \sum_6^7 \bar{P}_j Y_j \\ &= \frac{(2)(11,788.293)(-4.056)}{EI} + \frac{(39,294.636)(7.944)}{EI} \\ &= + \frac{216,529.955}{EI}\end{aligned}$$

Horizontal Loads:

$$\begin{aligned}\bar{R}_{6'}^H &= \frac{106.688 + 1,752.982 + (0.5)(2,681.305)}{EI} \\ &= + \frac{3,200.322}{EI}\end{aligned}$$

$$\begin{aligned}\bar{R}_{7'}^H &= \frac{(0.5)(2,681.305) + 546.134}{EI} \\ &= + \frac{1,886.786}{EI}\end{aligned}$$

$$\begin{aligned}\bar{M}_{6'7'}^H &= \frac{(106.688)(-14.056) + (1,752.982 + 546.134)(-4.056)}{EI} \\ &\quad + \frac{2,681.305}{EI} (7.944) \\ &= + \frac{10,475.467}{EI}\end{aligned}$$

$$X = 1.0 :$$

$$\begin{aligned}\bar{R}_{6'}^x &= \frac{5.000 + 24.405 + (0.5)(23.286)}{EI} \\ &= + \frac{41.048}{EI}\end{aligned}$$

$$\bar{R}_{7'}^x = \frac{(0.5)(23.286) + 3.581}{EI} = + \frac{15.224}{EI}$$

$$Y = 1.0 :$$

$$\bar{R}_{6'}^y = - \frac{15.224}{EI}$$

$$\bar{R}_{7'}^y = - \frac{41.048}{EI}$$

$$Z = 1.0 :$$

$$\begin{aligned}\bar{M}_{A'B'}^z &= \frac{(53.610)(2)(-14.056)}{EI} + \frac{(38.254)(2)(-4.056)}{EI} \\ &\quad + \frac{(-183.680)(7.944)}{EI} \\ &= - \frac{3,276.555}{EI}\end{aligned}$$

### 7. Moment and Force Functions

$$\begin{aligned}\bar{N} = \bar{R}_{6'}^x \bar{R}_{7'}^y - \bar{R}_{7'}^x \bar{R}_{6'}^y &= \frac{-(41.048)^2}{(EI)^2} - \frac{-(15.224)^2}{(EI)^2} \\ &= - \frac{1,453.168}{(EI)^2}\end{aligned}$$

$$\begin{aligned}K_{67} = K_{76} &= \frac{\bar{R}_{7'}^y}{\bar{N}} - \frac{e^2}{\bar{M}_{6'7'}^z} \\ &= \frac{-41.048 EI}{-1,453.168} - \frac{(14.056)^2 EI}{-3,276.555} \\ &= + 0.088 EI\end{aligned}$$

$$\begin{aligned}
 CK_{67} = CK_{76} &= \frac{\bar{R}_{6'}^y}{\bar{N}} + \frac{e^2}{\bar{M}_{6'7'}^z} \\
 &= \frac{-15,224 EI}{-1,453.168} + \frac{(14.056)^2 EI}{-3,276.555} \\
 &= -0.050 EI
 \end{aligned}$$

$$C_{67} = C_{76} = \frac{CK_{67}}{K_{67}} = \frac{-0.050}{0.088} = -0.568$$

$$K_{67}^H = K_{76}^H = -\frac{e}{\bar{M}_{6'7'}^z} = -\frac{14.056 EI}{-3,276.555} = +0.00429$$

$$FH_{67}^V = -FH_{76}^V = -\frac{\bar{M}_{6'7'}^V}{\bar{M}_{6'7'}^z} = -\frac{216,529.955}{-3,276.555} = +66.085^k$$

$$FH_{67}^H = FH_{76}^H = -\frac{10,475.467}{-3,276.555} = +3.197^k$$

$$FH_{67}^\Delta = -FH_{76}^\Delta = \frac{1}{\bar{M}_{6'7'}^z} \Delta_x = \frac{\Delta_x}{-3,276.555} = -0.00061EI\Delta_x$$

$$\begin{aligned}
 FM_{67}^V &= -FM_{76}^V = \frac{\bar{R}_{7'}^V \bar{R}_{6'}^y - \bar{R}_{6'}^V \bar{R}_{7'}^y}{\bar{N}} - \frac{\bar{M}_{6'7'}^V}{\bar{M}_{6'7'}^z} e \\
 &= \frac{(31,435.611)(-15.224 + 41.048)}{-1,453.168} \\
 &\quad - \frac{216,529.955}{-3,276.555} (14.056) = +370.254 \text{ k-ft.}
 \end{aligned}$$

$$\begin{aligned}
 FM_{67}^H &= FM_{76}^H \\
 &= \frac{(1,886.786)(-15.224) - (3,200.322)(-41.048)}{(-1,453.168)} \\
 &\quad - \frac{10,475.467}{(-3,276.555)} (14.056) \\
 &= -25.696 \text{ k-ft.}
 \end{aligned}$$

$$\begin{aligned}
 FM_{67}^{\Delta} &= - FM_{76}^{\Delta} = \frac{e}{\bar{M}_{6'7'}} \Delta_x = \frac{14.056 EI}{-3,276.555} \Delta_x \\
 &= - 0.00428 EI \Delta_x
 \end{aligned}$$

With these values the modified structure (Figure 6-4) may be solved by either the Moment Distribution Method or the Slope Deflection Method. The Moment Distribution solution follows:

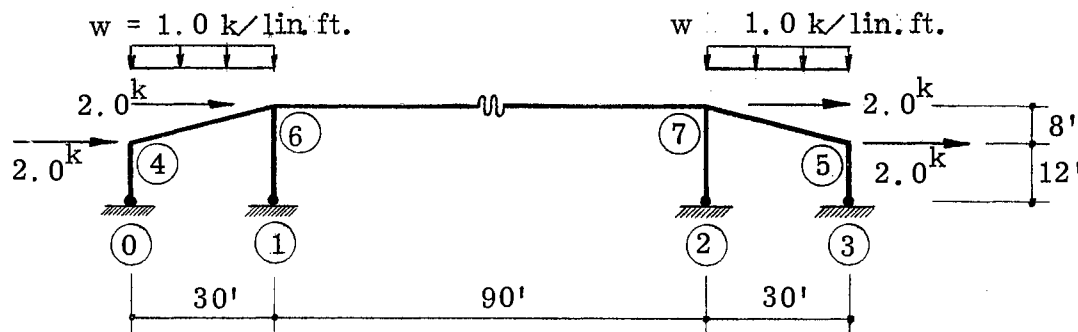

Figure 6-4

Modified Structure

### 8. Frame Constants

$$K'_{04} = K'_{35} = \frac{3EI}{L} = \frac{3EI}{12.0} = 0.250 EI$$

$$K'_{16} = K'_{27} = \frac{3EI}{20.0} = 0.150 EI$$

$$K_{46} = K_{57} = \frac{4EI}{31.048} = 0.129 EI$$

$$C's = 0.500$$

$$D'_{40} = \frac{0.250}{0.250 + 0.129} = 0.660$$



$$D'_{46} = \frac{0.129}{0.379} = 0.340$$

$$\begin{aligned} FM_{46}^L &= - FM_{64}^L = - FM_{57}^L = FM_{75}^L = \frac{WL^2}{12} \\ &= \frac{(1.0)(30,000)^2}{12} = + 75,000 \text{ k-ft} \end{aligned}$$

$$\begin{aligned} EM_{40}^{\Delta} &= EM_{53}^{\Delta} = \frac{3EI}{L^2} \Delta_x = \frac{3EI}{144.00} \Delta_x = 0.021 EI \Delta_x \\ &= + 210,000 X_1 \end{aligned}$$

$$EM_{61}^{\Delta} = EM_{72}^{\Delta} = \frac{3EI}{400.00} \Delta_x = 0.0075 EI \Delta_x = + 75,000 X_1$$

### 9. Modifications for Symmetry and Anti-Symmetry

Symmetry:

$$K''_{67} = K_{67} (1 - C) = 0.088(1 + 0.568) EI = 0.138 EI$$

$$D''_{64} = \frac{0.129}{0.417} = 0.309$$

$$D''_{61} = \frac{0.150}{0.417} = 0.360$$

$$D''_{67} = \frac{0.138}{0.417} = 0.331$$

$$\begin{aligned} FM_{67}^{\Delta} &= - 0.00428 EI (\Delta_7 - \Delta_6) = - 0.00428 EI (2\Delta_6) \\ &= - 85.600 X_1 \end{aligned}$$

$$FH_{67}^{\Delta} = - 0.00061 EI (\Delta_7 - \Delta_6) = - 6.100 X$$

Anti-Symmetry:

$$K'''_{67} = K_{67} (1 + C) = 0.088 (1 - 0.568) EI = 0.038 EI$$

$$D'''_{64} = \frac{0.129}{0.317} = 0.407$$

$$D'''_{61} = \frac{0.150}{0.317} = 0.473$$

$$D'''_{67} = \frac{0.038}{0.317} = 0.120$$

$$FM_{67}^{\Delta} = 0$$

$$FH_{67}^{\Delta} = 0$$

### 10. Distribution Procedure

Symmetrical - Loads:

40	46	64	61	67	
+ 0.660	- 0.340	- 0.309	- 0.360	- 0.331	
————	+ 0.500	+ 0.500	————	————	
————	- 75.000	+ 75.000	————	+370.254	
		-137.583	-160.290	-147.379	
	- 68.792				
+ 94.903	+ 48.889	+ 24.445			
		- 7.554	- 8.800	- 8.091	
	- 3.777				
+ 2.493	+ 1.284	+ 0.642			
		- 0.198	- 0.231	- 0.212	
+ 97.396	- 97.396	- 45.248	-169.321	+214.572	M
+ 97.396	- 22.396	-120.248	-169.321	-155.682	RM

Symmetrical -  $\Delta_1$ :

+210.000	————	————	+ 75.000	- 85.600	
		+ 3.275	+ 3.816	+ 3.509	
	- 1.637				
-139.680	- 71.957	- 35.978			
		+ 11.117	+ 12.952	+ 11.909	
	+ 5.558				
- 3.668	- 1.890	- 0.945			
		+ 0.292	+ 0.340	+ 0.313	
	+ 0.146				
- 0.096	- 0.050				
+ 66.556	- 66.556	- 22.239	+ 92.108	- 69.869	M
-143.444	- 66.556	- 22.239	+ 17.108	+ 15.731	RM

## Anti-Symmetrical - Loads:

40	46	64	61	67	
- 0.660	- 0.340	- 0.407	- 0.473	- 0.120	
	+ 0.500	+ 0.500			
				- 25.696	
	+ 5.229	+ 10.458	+ 12.154	+ 3.084	
- 3.451	- 1.778				
		- 0.889			
		+ 0.362	+ 0.420	+ 0.107	
	+ 0.181				
- 0.119	- 0.062				
- 3.570	+ 3.570	+ 9.931	+ 12.574	- 22.505	M
- 3.570	+ 3.570	+ 9.931	+ 12.574	+ 3.191	RM

Anti-Symmetrical -  $\Delta_1$ 

+210.000			+ 75.000		
-138.600	- 71.400				
		- 35.700			
		- 15.995	- 18.588	- 4.716	
	- 7.998				
+ 5.279	+ 2.719				
		+ 1.359			
		- 0.553	- 0.643	- 0.163	
	- 0.276				
+ 0.182	+ 0.094				
+ 76.861	- 76.861	- 50.889	+ 55.769	- 4.879	M
-133.139	- 76.861	- 50.889	- 19.231	- 4.879	RM

## 11. Shear Equation

Symmetrical:

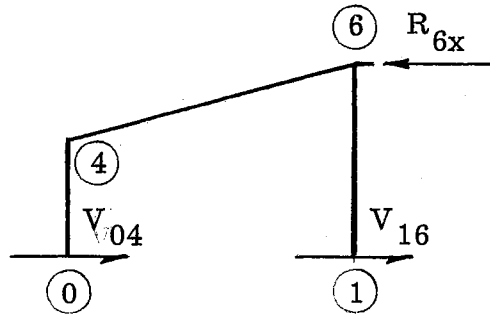

Figure 6-5

Free-Body Diagram

$$\gamma_{67} = \frac{K_{67}^H (1 + C_{67})}{K_{67} (1 - C_{67} C_{76})} = \frac{(0.00429)(1 - 0.568)}{(0.088)(1 - 0.323)} = 0.031$$

$$\begin{aligned} R_{6x} &= \gamma_{67} (RM_{67} - RM_{76}) + FH_{67}^V + FH_{67}^{\Delta} \\ &= (0.031)(-155.682 + 15.731X_1) + 66.085 - 6.100 X_1 \\ &= + 61.259 - 5.612 X_1 \end{aligned}$$

$$V_{04} = \frac{M_{40}}{L} = \frac{97.396 + 66.556X_1}{12.0} = + 8.116 + 5.546 X_1$$

$$V_{16} = \frac{M_{61}}{L} = \frac{-169.321 + 92.108X_1}{20.0} = -8.466 + 4.605 X_1$$

$$V_{04} + V_{16} - R_{6x} = 0$$

$$\begin{aligned} 0 &= (8.116 - 8.466 - 61.259) + (5.546 + 4.605 + 5.612)X_1 \\ &= -61.609 + 15.763 X_1 \end{aligned}$$

$$X_1^S = \frac{61.609}{15.763} = + 3.908$$

Anti-symmetrical:

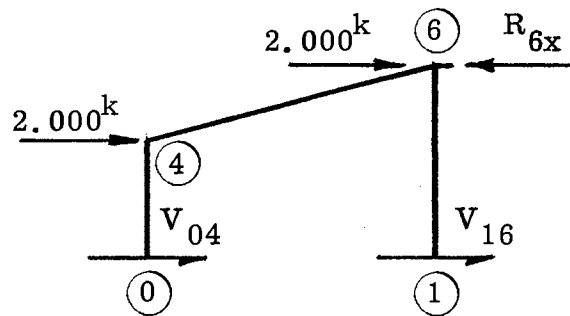

Figure 6-6

Free-Body Diagram

$$\begin{aligned} R_{6x} &= (0.031)(+ 3.191 - 4.879 X_1) + 3.197 - 6.400 \\ &= - 3.104 - 0.151 X_1 \end{aligned}$$

$$V_{04} = \frac{- 3.570 + 76.861 X_1}{12.0} = - 0.298 + 6.405 X_1$$

$$V_{16} = \frac{+ 12.574 + 55.769 X_1}{20.0} = + 0.629 + 2.788 X_1$$

$$V_{04} + V_{16} + 4.000 - R_{6x} = 0$$

$$\begin{aligned} 0 &= (-0.298 + 0.629 + 3.104 + 4.000) \\ &\quad + (6.405 + 2.788 + 0.151) X_1 \\ &= + 7.733 + 9.344 X_1 \end{aligned}$$

$$X_1 = - \frac{7.733}{9.344} = - 0.828$$

12. Final Moments

Symmetrical:

$$M_{40} = + 97.396 + 260.100 = + 357.497 \text{ k-ft.}$$

$$M_{46} = - 97.396 - 260.100 = - 357.497 \text{ k-ft.}$$

$$M_{64} = - 45.248 - 86.910 = - 132.158 \text{ k-ft.}$$

$$M_{61} = - 169.321 + 359.958 = + 190.637 \text{ k-ft.}$$

$$M_{67} = + 214.572 - 273.048 = - 58.476 \text{ k-ft.}$$

$$\Sigma M_7 = 0 \rightarrow$$

$$0 = - 58.476 + 58.476 - (90.000)(45.000) \\ + R_{6y} (90.000)$$

$$R_{6y} = \frac{4,500.000}{90.000} = + 45.000 \text{ k}$$

$$R_{6x} = + 61.259 - (5.612)(3.908) = + 39.327 \text{ k}$$

$$M_{68} = - 58.476 \text{ k-ft.}$$

$$M_{86} = - 58.476 - (39.327)(10.00) = + 451.746 \text{ k-ft.}$$

$$M_{89} = - 451.746 \text{ k-ft.}$$

$$M_{98} = - 58.476 - (39.327)(22.00) + (45.00)(45.00) \\ - (45.00)(22.50) \\ = + 88.830 \text{ k-ft.}$$

Anti-symmetrical:

$$M_{40} = - 3.570 - 63.700 = - 67.270 \text{ k-ft.}$$

$$M_{46} = + 3.570 + 63.700 = + 67.270 \text{ k-ft.}$$

$$M_{64} = + 9.931 + 42.200 = + 52.131 \text{ k-ft.}$$

$$M_{61} = + 12.574 - 46.250 = - 33.676 \text{ k-ft.}$$

$$M_{67} = - 22.505 + 4.040 = - 18.465 \text{ k-ft.}$$

$$\Sigma M_7 = 0 \quad \curvearrowright$$

$$0 = - 18.465 - 18.465 + (6.400)(10.00) \\ + R_{6y} (90.00)$$

$$R_{6y} = - \frac{27.070}{90.000} = - 0.301 \text{ k}$$

$$R_{6x} = - 3.104 - (0.151)(-0.828) = -2.979 \text{ k}$$

$$M_{68} = - 18,465 \text{ k-ft.}$$

$$M_{86} = - 18,465 + (2.979)(10.000) = + 11.325 \text{ k-ft.}$$

$$M_{89} = - 11.325 \text{ k-ft.}$$

$$M_{98} = - 18.465 + (2.979)(22.00) - (0.301)(45.00) \\ - (3.200)(12.00) \\ = - 4.872 \text{ k-ft.}$$

## CHAPTER VII

### SUMMARY AND CONCLUSIONS

The slope deflection equations for a symmetrical bent member are derived and the conjugate expressions for the moment and force functions are defined. The procedure for the analysis of this type of member is outlined and one numerical example is included. The example illustrates this procedure and the integration of this method in the analysis of a complex structure.

The slope deflection equations, in terms of loads and end displacements, for a symmetrical bent member completely describe its end reactions. Further investigation of the loads or displacements at points within the member is eliminated. The bent member in the real structure is replaced by a straight elastic bar for the purpose of solution by either slope deflection or moment distribution.

The application of the String Polygon Method to the solution of complex or continuous structures may eliminate much of the laborious work connected with the solution of simultaneous equations and moment distributions procedures. The String Polygon Method becomes more advantageous as the number of joints in the bent member increases and more displacements are introduced.



## A SELECTED BIBLIOGRAPHY

1. Tuma, J. J. and J. T. Oden, "Frames with Straight Members by the String Polygon", Proceedings, A. S. C. E., Structural Division (To be published September, 1961).
2. Boecker, Henry C., "Analysis of Pinned-End Frames by the String Polygon Method", M. S. Thesis, Oklahoma State University, Stillwater, August, 1960.
3. Tuma, J. J., T. Lassley, and S. French, "Analysis of Continuous Beam Bridges, Vol. I, Carry-Over Procedure", School of Civil Engineering Research Publication No. 3, Oklahoma State University, Stillwater, 1959.
4. Exline, J. W., "String Polygon Constants for Members with Sudden Changes in Section", M. S. Thesis, Oklahoma State University, Stillwater, August, 1961.
5. Yu, H. S., "Analysis of Wedged Frames with Bent Members by the String Polygon Method", M. S. Thesis, Oklahoma State University, Stillwater, August, 1961.
6. Tuma, J. J., "The String Polygon Method in Structural Analysis", Lecture Notes, C. E. 620 - Seminar, Oklahoma State University, Stillwater, Spring, 1960.
7. Chu, S. L., "Beam Constants by the String Polygon Method", M. S. Thesis, Oklahoma State University, Stillwater, August, 1959.
8. Wu, C. M., "The General String Polygon", M. S. Thesis, Oklahoma State University, Stillwater, 1960.
9. Oden, J. T., "Analysis of Fixed-End Frames with Bent Members by the String Polygon Method", M. S. Thesis, Oklahoma State University, Stillwater, August, 1960.
10. Gonulsen, Y. I., "Analysis of Ridged Truss Frames by the String Polygon Method", M. S. Thesis, Oklahoma State University, Stillwater, August, 1961.
11. Ramey, J. D., "Elastic Weights for Trusses by the String Polygon Method", M. S. Thesis, Oklahoma State University, Stillwater, (in preparation).

## VITA

Glenn Douglas Houser

Candidate for the Degree of

Master of Science

Thesis: SLOPE DEFLECTION EQUATIONS FOR SYMMETRICAL BENT MEMBERS BY THE STRING POLYGON METHOD

Major Field: Civil Engineering (Structures)

Biographical:

Personal Data: Born June 20, 1931 in Omaha, Nebraska, the son of Louis B. and Marjorie L. Houser.

Education: Graduated from Central High School, Omaha, Nebraska in June 1949. Attended the University of Omaha. Received the degree of Bachelor of Architectural Engineering from Oklahoma State University, June, 1960. Member of Phi Eta Sigma. Completed requirements for the Master of Science degree in May, 1962.

Professional Experience: United States Navy from June, 1951 to June, 1955 serving as a draftsman in Japan; Student Trainee (Structural) and Structural Engineer, Corps of Engineers, United States Army, summers of 1956 through 1960; Graduate Assistant, School of Civil Engineering, Oklahoma State University, November, 1959 to August, 1961.